

Banner General Technical Reference Manual

*Release 8.1
October 2008*



SUNGARD HIGHER EDUCATION

What can we help you achieve?

SunGard Higher Education

4 Country View Road
Malvern, Pennsylvania 19355
United States of America
(800) 522 - 4827

Customer Support Center Website

<http://connect.sungardhe.com>

Documentation Feedback

<http://education.sungardhe.com/survey/documentation.html>

Distribution Services E-mail Address

distserv@sungardhe.com

Other Services

In preparing and providing this publication, SunGard Higher Education is not rendering legal, accounting, or other similar professional services. SunGard Higher Education makes no claims that an institution's use of this publication or the software for which it is provided will insure compliance with applicable federal or state laws, rules, or regulations. Each organization should seek legal, accounting and other similar professional services from competent providers of the organization's own choosing.

Trademark

Without limitation, SunGard, the SunGard logo, Banner, Campus Pipeline, Luminis, PowerCAMPUS, Matrix, and Plus are trademarks or registered trademarks of SunGard Data Systems Inc. or its subsidiaries in the U.S. and other countries. Third-party names and marks referenced herein are trademarks or registered trademarks of their respective owners.

Revision History Log**Publication Date Summary**

October 2008	New version that supports Banner General 8.1 software.
--------------	--

Notice of Rights

Copyright © SunGard Higher Education 1993, 2008. This document is proprietary and confidential information of SunGard Higher Education Inc. and is not to be copied, reproduced, lent, displayed or distributed, nor used for any purpose other than that for which it is specifically provided without the express written permission of SunGard Higher Education Inc.



Think before you print.

Contents



Chapter 1 Banner Standards

Naming Banner Objects1-1
Naming Client-Developed Items1-1
Column Names1-2
Database Programming Object Naming Standards1-3
The dbprocs Directory1-3
Indexes1-8
Banner Constraint Naming Convention1-8
Primary Keys1-9
Foreign Keys1-9
Check Constraints1-10
Unique Constraints1-10
Data Format Recommendations1-12
SunGard-Delivered User IDs1-13
BASELINE and LOCAL User IDs1-14
Directory Structure1-15
COBOL Standards1-20
Rules1-20
Standards1-22
Style1-23

C Standards1-25
Introduction1-25
Rules1-25
Standards1-30
Style.1-33

Chapter 2 Banner Forms

Banner Forms Architecture2-1
Introduction2-1
The Logical View2-3
Implementation View2-19
Case View.2-29
Standards for Forms2-35
Naming Conventions2-35
Visual Cues2-36
Blocks.2-38
Scroll Bars2-38
Navigation.2-39
Text Items2-39
Check Boxes, Radio Groups, Pull Down Lists2-40
Buttons2-41
Menus.2-42
Creating Custom Banner Forms2-45
Guidelines for Updating Forms for Banner 8.02-45

Chapter 3 Online Internal Processing

Global Variables3-1
General Global Variables3-2
How PIDMs and IDs are Generated.3-2
Filling Gaps in PIDM or ID Number Series3-3
The SOBSEQN Method Used in Release 6.x.3-4

Banner Libraries3-4
GOQOLIB3-4
GOQRPLS3-5
GOQCLIB3-17
Workflow Banner Adapter Library (GOQWFLW)3-17
Oracle Advanced Queuing3-18
Large Object Storage3-19
Considerations for Building Custom Applications3-19

Chapter 4 Upgrade Assistance

Upgrade Modification History/Maintenance (GUASMOD)4-1
Stage Modification History4-2
Stage Modification Maintenance Header/Detail4-3
Stage Modification History Details Window4-4

Chapter 5 Banner Integration

Common Tables5-1
Common Objects5-6
Ethnicity Codes in Banner5-13
Ethnic Distinctions5-14
New Race and Ethnicity Categories5-14
Nonresident Aliens5-15

Chapter 6 Reports and Processes

Enhanced Oracle*Reports6-1
Enhanced Security for Oracle*Reports6-2
Setting Up Banner to Run the Enhanced Oracle*Reports6-3
Setting Up Default Values for Parameters 71-776-3
User Preferences for Oracle Reports Output6-6

Changes to Support Enhanced Oracle Reports6-9
Student, Finance, and Accounts Receivable Reports.6-9
Parameters 71-77.6-10
7.1 Changes for Forms that Call Oracle Reports6-11
7.1 Changes for Oracle Reports RDF Files.6-12
General PL/SQL Oracle*Reports Library (GOQOREP).6-15
Dynamic Procedure Library (GOQRPLS).6-18
Reports in Banner General6-18
Perl Reports.6-19
Report and Process Attributes6-20
Trace Mode (Debug) for General COBOL Programs6-21
SQL*Plus Scripts6-23
Sleep/Wake Methods6-30
Method One.6-30
Method Two.6-32
Operating Systems Without Sleep/Wake-up Commands.6-33
Job Submission6-34
Jobs Submitted from GJAPCTL6-34
Jobs Submitted from Application Forms6-35
The GUQINTF Form6-36
UNIX6-37
OpenVMS.6-40
Windows Platform.6-42
Job Submission Processing6-43
GURJOBS6-47
Managing Job Submission on Windows6-48
Viewing Job Submission Output6-49
Data Extract Process6-50
Data Extract Tables6-51

Chapter 7 APIs

APIs Used in Banner General7-1
APIs Used in Banner General with Student Forms and Tables7-5
APIs for Internal Banner Operations7-7

Chapter 8 Interfaces

Interfaces with External User Systems8-1
Interfaces within Banner8-2

Chapter 9 Generating and Compiling

Form Generation9-1
Mass Form Generation Scripts9-1
COBOL Compiling9-2
Compiling COBOL under UNIX9-2
Compiling COBOL under OpenVMS9-5
COBOL Compiling During Banner Installation9-6
C Compiling9-8
Compiling C under UNIX9-8
Compiling C under OpenVMS9-12
C Compiling During Banner Installation9-12

Chapter 10 Desktop Tools

Desktop Tools10-1
Minimum System Requirements10-1
Installing Desktop Tools in a Windows Environment10-2
Installing Desktop Tools in Other Environments10-5
Forms10-6
Tables10-7

Chapter 11 System-Required Data

System-Required Tables11-2
Tables Owned by BANSECR11-2
Large Tables11-2
Other Tables11-3
System-Required Rows11-3

Troubleshooting

SQL TraceT-1
Starting a SQL Trace in GUAINIT.T-2
Capturing Runtime StatisticsT-2

Index



Naming Banner Objects

Banner form, report, job, and table names have a 7-character structure. The first and second characters identify the system and module, the third character identifies the type of object, and the four remaining characters are used as a unique identifier for the object. These naming standards, and the meanings of each letter in the first, second, and third positions, are detailed in Chapter 1, “Overview,” of the *Banner Getting Started Guide*.

For naming standards of APIs, see Chapter 1, “Overview,” of the *Banner API Developer Guide*.

Naming Client-Developed Items

SunGard Higher Education has reserved the letters *W*, *Y*, and *Z* for use in Positions 1 and 2 of the names of all client-developed applications, forms, reports, tables and modules.

For client-developed *new applications* built to coexist with Banner applications, *W*, *Y*, or *Z* should be used as the first character.

For client-developed *forms or modules* used within a Banner application, the SunGard system identifier is used as the first character (for example, *G* for General), and *W*, *Y*, or *Z* should be used as the second character.

Note

After you create a custom form, be sure to access the Object Maintenance Form (GUAOBS) and associate it with a System indicator code, (e.g, *A* for Advancement, *G* for General, *F* for Finance, etc.) These codes are defined on the System Indicator Validation Form (GTVSYSI). If you want to classify your form as a custom form rather than associating it with a Banner system, you can set up *W*, *Y*, and *Z* on GTVSYI and use that code on GUAOBS.

If you set up a code other than *W*, *Y* or *Z* on GTVSYI and use it on GUAOBS, it is possible that Banner may not display your custom form on the appropriate menus. ■

For client-developed *reports* used within a Banner application, the SunGard system identifier must be used as the first character (for example, *G* for General and so forth), and *W*, *Y*, or *Z* should be used as the second character.

For client-developed *tables* used within a Banner application, the SunGard system identifier must be used as the first character (for example, *G* for General and so forth), and *W*, *Y*, or *Z* should be used as the second character.

For client-developed *programs* used within a Banner application, the SunGard system identifier must be used as the first character (for example, *G* for General and so forth), and *W*, *Y*, or *Z* should be used as the second character.

Column Names

Application Tables (Base/Repeating)

Column names start with the seven-character table name, followed by an underscore and an expression that uniquely identifies the column within the table. For example:

```
GJBJOBS_NAME  
APBCONS_PIDM
```

Column names that correspond to a validation table must contain the seven-character application table name followed by an underscore, the four-character validation table identifier, an underscore, and *CODE*. For example:

```
GJBJOBS_PRNT_CODE  
APRCATG_DONR_CODE
```

If multiple columns are needed for the same validation table identifier, column names are made unique by appending a number or a unique name to the end of the name of the column. For example:

```
GURFEED_PAYT_CODE  
GURFEED_PAYT_CODE_TRANSCRIPT  
APBCONS_ATYP_CODE_PREF  
APBCONS_ATYP_CODE_CM
```

The name of the last activity date column begins with the seven-character table name followed by an underscore and *ACTIVITY_DATE*. For example:

```
GTVLETR_ACTIVITY_DATE  
APBCONS_ACTIVITY_DATE
```

The name of the updating user ID column begins with the seven-character table name followed by an underscore and *USER_ID*. For example:

```
GURAPAY_USER_ID
```

Validation Tables

The validation table and corresponding form have the same name. Both start with *GTV* followed by a unique four-character identifier. For example:

`GTVCALL`

The name of the key column begins with the seven-character table name followed by an underscore and *CODE*. For example:

`GTVCALL_CODE`

The name of the description column begins with the seven-character table name followed by an underscore and *DESC*. For example:

`GTVCALL_DESC`

The name of columns that are used as indicators begins with the seven-character table name and end with an underscore and *IND*. For example:

`GTVCALL_DUPL_IND`

The name of the last activity date column begins with the seven-character table name followed by an underscore and *ACTIVITY_DATE*. For example:

`GTVCALL_ACTIVITY_DATE`

A unique index is created for the validation table using the key columns to prevent duplicates from being added to the system.

Database Programming Object Naming Standards

The dbprocs Directory

The `dbprocs` directory, found under each product directory, stores the database programming object *create* scripts (for triggers, packages, etc.). This directory also stores Banner APIs (see Chapter 7, “APIs”).

Scripts That Create Triggers

All scripts in the `dbprocs` directory that pertain to the creation of database triggers are named using the following standard:

`abcddddde.sql`

a = Product identifier (S)tudent, (P)ayroll etc.
b = Module (E)mployee, (B)udget etc.
c = (T)rigger
dddd = Table identifier such as PERS, IDEN, EMPL etc.
e = Number 0 through 9, letters a through z

 **Note**

This becomes `aabcddde.sql` for those products that have a double character identifier. They sacrifice one of the table identifier letters: *dddd* becomes *ddd*. ■

The script has the same name as the table except that the third position is replaced with the letter *t* to denote a trigger. Each script ends with a number so the programming logic can have multiple triggers for the same table. If there are more than 10 triggers for a table, each script ends in a letter. For example:

`sptpers0.sql` - First database trigger for the SPBPERS table
`sptiden7.sql` - Eighth database trigger for the SPRIDEN table
`petemplc.sql` - Thirteenth database trigger for the PEBEMPL table

Duplicate Names

The standards for script names could potentially lead to duplicate names from time to time.

For example, if a trigger is created for both the NBBJOBS table and the NBRJOBS table you end up with two create scripts that should be named `nbtjobs0.sql`. This will not occur often, but when it does a small modification to one or both of the script names is suggested to make them unique. For example, `nbtjobs0.sql` for the NBBJOBS trigger and `nbtjob20.sql` for the NBRJOBS trigger.

Scripts that Create Packages, Procedures, and Functions

All scripts in the `dbprocs` directory that pertain to the creation of database objects that can be packages, procedures, and functions are named using the following standard:

`abcdddd.sql`

a = Product identifier (S)tudent, (P)ayroll, etc.
b = Module (E)mployee, (B)udget, etc.
c = Pac(K)age, (P)rocedure, (F)unction
dddd = Four-character mnemonic which uniquely identifies the object

 **Note**

If the product identifier is two characters, the standard becomes `aabcddd.sql`. ■

The following table lists examples of this naming standard.

gefcmnt.sql	(G)eneral (E)vent (F)unction for (CMNT) comments
shkgpac.sql	(S)tudent Academic (H)istory Pac(K)age for (G)rade (P)oint (A)verage (C)alculation.
nbkencc.sql	Positio(N) Control (B)udget Pac(K)age for (Enc)umbrance (C)alculation.
noforgc.sql	Positio(N) Control (O)verall (F)unction for (Org) (C)harting.

The same 7-character name will be used to name the package object within the database.

Line Extension Products

Line extension products use zzacbdd (the *c* before the *b* is intentional) where:

zz= Line extension product.
a= Baseline product identifier.
c= Pac(K)age, (P)rocedure, (F)unction
b= Module name.
ddd= Table identifier

For example:

hwpkeinf

hw = Self-Service line extension product
p =Human Resources baseline product
k = Pac(K)age
e = (E)mployee module.
inf = (Inf)ormation

At the discretion of the programmer/project leader, the specification for the package may or may not, be separated from the body. They are typically separate unless they are very small packages. When split, the two scripts would be named the same except for a *1* appended to the body script name.

For example, shkgpac.sql would be the script to create the specification and shkgpac1.sql would be the script to create the body. You can use all eight characters for the specification script, for example, sckgpac0.sql would be the script to create the specification and shkgpac1.sql would be the script to create the body.

Triggers

Database trigger objects within the database are named as follows:

`at_abcdddd_XXXXXXXXXXXXXXXXXXXX` (a total of 29 characters)

where:

a = Product identifier (S)tudent, (P)ayroll etc.

t = (T)rigger

abcdddd = Table name

XXXXXXXXXX... = Meaningful trigger name up to 18 characters in length

For example:

```
gt_spriden_name_compress  
pt_pebempl_audit_trail_upd
```

Packages

Packages should contain their functions, procedures, etc. in alphabetical order by object name.

Procedures and functions can be created as stand-alone objects or contained within a package. There are a number of factors that contribute to this decision; therefore, it is determined by the programmer/technical project leader. The database objects that are procedures or functions will be named as follows:

`p_XXXXXXXXXXXXXXXXXXXXXXXXXXXX` (a total of 29 characters)

`f_XXXXXXXXXXXXXXXXXXXXXXXXXXXX`

where

p = (P)rocedure

f = (F)unction

XXXXXXXXXX... = Meaningful name up to 27 characters in length

For example:

```
p_grade_point_avg_calc  
f_fund_override  
p_salary_enc_calc  
f_check_for_event_comments
```

For Oracle to execute a SQL statement that calls a packaged function, you must assert its purity level by coding the pragma `RESTRICT_REFERENCES` directive in the package specification. The pragma `RESTRICT_REFERENCES` directive is not required to execute a packaged function in procedural statements. Please refer to the *Oracle 9i Application Developer's Guide - Fundamentals, Release 2* for more information.

Although, based on this standard, the names of functions and procedures can be up to 29 characters in length, it is strongly recommended that the names be kept shorter where possible. Many products outside of Banner have size limitations for these names; therefore, a shorter name is safer.

Cursors

Cursors are named as follows:

xxxxxxxxxxxxxxxxxxxxxxxxxxxxxxxxxxxxC (a total of 29 characters)

Where:

C = (C)ursor

xxxxxxxx... = Meaningful name up to 28 characters in length. It is strongly recommended that the *C* be preceded by an underscore.

For example:

ytd_benefit_values_C
students_who_are_employees_C
delinquent_accounts_C

If the cursor returns all the columns for one table it is recommended that the cursor name = tablename_C (i.e., Spbpers_C, Stvterm_C).

User-Defined Types

User-defined types are named as follows in the database:

a_xxxxxxxxxxx[_nt] (up to 29 characters)

Where:

a = product identifier

xxxxxxxx... = mnemonic that uniquely identifies the object

_nt literal is added to the end if the object is a nested type

For example:

g_idname_search
g_idname_search_nt

A synonym must be created for all packages for the objects within those packages to be accessed by all Oracle Tools. For example, you cannot invoke `baninst1.nbkenc.p_count_days_fisc_yr` from Oracle Forms because of the two periods (i.e., `owner.package_name.procedure_name`). A synonym must be created for the package by stripping off the `BANINST1` owner. In our example we end up with a synonym named `nbkenc` and so we can then invoke the procedure by referencing it as

`nbkenc.p_count_days_fisc_yr`. Using the synonym to mask the BANINST1 owner in this fashion is also consistent with how we handle the table names.

A synonym must be created for all packages. The synonym name is the same as the package except that the BANINST1 owner designation is stripped from the front.

For example:

Package name: `baninst1.nbkenc`
Synonym: `nbkenc`

Indexes

The unique index on each table is named as follows:

7-character table name_key_index

Each additional index is numbered numerically, starting with 2 after indexes, as follows:

7-character table name_key_index2
7-character table name_key_index3
etc.

Banner Constraint Naming Convention

The following four constraint types are available in Oracle databases:

1. Primary key constraints— to enforce unique, non-null keys
2. Foreign key constraints— to ensure children rows are not updated/inserted if parent rows do not exist, and to prevent the deletion of parent rows if children rows do exist
3. Check constraints— to enforce integrity issues specified by the check condition
4. Unique constraints— designates a column or a combination of columns as a unique key

A constraint name must be unique for a given owner.

Note

Some foreign key constraints are delivered disabled to remove the negative performance impact of the additional indexes. They are for documentation purposes only. ■

Primary Keys

Primary keys must be defined in the following fashion:

“PK_” + ppppppp
where PK for Primary Key,
ppppppp = primary key table name

Example: The primary key for STVTERM should be named PK_STVTERM.

Foreign Keys

Foreign keys can be defined in the following two situations:

- Defining referential integrity constraints referencing the validation tables
- Defining referential integrity constraints for application hierarchy

Defining Referential Integrity Constraints Referencing the Validation Tables

Foreign keys in this category should be defined as follows:

“FK” + n + “_” + fffffff + “_INV_” + ppppppp + “_CODE”

where FK for Foreign Key

n = an one-up number to distinguish potential duplicate foreign key names in a given table

ffffff = foreign key table name

ppppppp = primary key table name

Example: The foreign key name for column SCBCDEP_TERM_CODE_START should be FK1_SCBCDEP_INV_STVTERM_CODE.

The foreign key name for column SCBCDEP_TERM_CODE_END should be
FK2_SCBCDEP_INV_STVTERM_CODE.

Defining Referential Integrity Constraints for Application Hierarchy

Foreign keys in this category should be defined in the following fashion:

“FK” + n + “_” + fffffff + “_INV_” + ppppppp + “_KEY”

where FK = Foreign Key

n = an one-up number to distinguish potential duplicate foreign key names in a given table

ffffff = foreign key table name

ppppppp = primary key table name

Check Constraints

SunGard recommends the following two possible standards:

1. "CC" + n + "_" + cccccc
where CC for Check Constraint
n = an one-up number to distinguish potential duplicate check
constraint key names in a given table
ccccc = column name

Example: The check constraint name for checking the range of SCRSCHD_WORKLOAD would be CC1_SCRSCHD_WORKLOAD.

2. "CC" + x + "_" + tttttt + "_" + mmmmmmm
where CC = Check Constraint
x = a checking category code

For example, R for range checking, V for value checking, etc.

tttttt = table name
mmmmmm = message

Example: The check constraint name for checking the range of SCRSCHD_WORKLOAD would be CCR_SCRSCHD_outside_0_and_999.

Unique Constraints

Unique constraints must be defined in the following fashion:

"uk" + n + _pppppp + _ + dddddd
where UK for unique constraint

n = an one-up number to distinguish potential duplicate unique
constraints in a given table.
dddddd = descriptive name

Example 1

To illustrate the situation where referential integrity is to be defined for the application hierarchy, let us assume there are three parent-child tables in the system:

```
XXXXXX, YYYYYY and ZZZZZZ.  
12:14:40 SQL> desc XXXXXX;  
Name                               Null?   Type  
-----
```

```

A                                     CHAR(1)
12:14:47 SQL> desc YYYYYYY;
Name                                 Null?   Type
-----
A                                     CHAR(1)
B                                     CHAR(1)
12:14:51 SQL> desc ZZZZZZ;
Name                                 Null?   Type
-----
A                                     CHAR(1)
B                                     CHAR(1)
C                                     CHAR(1)

```

Table YYYYYYY is the child of table XXXXXXXX and table ZZZZZZ is the child of table YYYYYYY.

The following statement defines primary key for table XXXXXXXX to enforce a unique, not null value:

```

12:14:56 SQL> alter table XXXXXXXX
12:15:03      2          add constraint PK_XXXXXXX
12:15:12      3          primary key ( A );
Table altered.

```

The following statement defines foreign key for table YYYYYYY referencing the primary key of table XXXXXXXX to ensure the value of A exists in XXXXXXXX before allowing inserts/updates to YYYYYYY. Deletes of A from XXXXXXXX only when the value of A does not exist in YYYYYYY:

```

12:15:23 SQL> alter table YYYYYYY
12:15:28      2          add constraint FK1_YYYYYYY_INV_XXXXXXX_KEY
12:15:43      3          foreign key ( A )
12:15:51      4          references XXXXXXXX ( A );
Table altered.

```

The following statement defines primary key for table YYYYYYY:

```

12:16:12 SQL> alter table YYYYYYY
12:16:18      2          add constraint PK_YYYYYYY
12:16:26      3          primary key ( A, B );
Table altered.

```

The following statement defines foreign key for table ZZZZZZ referencing the primary key of table YYYYYYY:

```

12:16:38 SQL> alter table ZZZZZZ
12:16:43      2          add constraint FK1_ZZZZZZ_INV_YYYYYYY_KEY
12:16:57      3          foreign key ( A, B )

```

```
12:17:09 4 references YYYYYYY ( A, B );
Table altered.
```

Example 2

Using the sample defined above, the following error messages are generated when constraints are violated:

The following statement inserted a row into table XXXXXXXX successfully:

```
12:18:03 SQL> insert into XXXXXXXX values ( '1' );
1 row created.
```

The following statement failed the PK_XXXXXXX primary key constraint, because a primary key must have unique value:

```
12:18:14 SQL> insert into XXXXXXXX values ( '1' );
insert into XXXXXXXX values ( '1' )
*
ERROR at line 1:
ORA-00001: unique constraint (SATURN.PK_XXXXXXX) violated
```

The following statement passed FK1_YYYYYYY_INV_XXXXXXX_KEY constraint checking and added a row into table YYYYYYYY;

```
12:18:26 SQL> insert into YYYYYYYY values ( '1', '1' );
1 row created.
```

The following statement caused foreign key violation, because there is not a primary key value ('2', '2') in table YYYYYYYY yet:

```
12:18:53 SQL> insert into ZZZZZZZ values ( '2', '2', '1' );
insert into ZZZZZZZ values ( '2', '2', '1' )
*
ERROR at line 1:
ORA-02291: integrity constraint (SATURN.FK1_ZZZZZZZ_INV_YYYYYYY_KEY)
violated - parent key not found
```

Data Format Recommendations

To ensure consistent information throughout your Banner system, data should be entered in a standard way. See Chapter 3, “Getting Around Banner,” in the *Banner Getting Started Guide* for recommendations on the format of IDs, names, addresses, dates, and the use of special characters.

SunGard-Delivered User IDs

Below is a list of the user IDs that are delivered with Banner.

 **Note**

Some of the IDs are used with systems that are no longer part of the Banner suite. They will be made obsolete in a future release. ■

The following are sample user accounts for role-level security, etc.

USR IDs	Description
ADISUSR	Sample user account for role-level security, etc., for Advancement.
FAISUSR	Sample user account for Financial Aid.
FIMSUSR	Sample user account for Finance.
HRISUSR	Sample user account for Human Resources.
LIMSUSR	Obsolete.
SAISUSR	Sample user account for Student.

The following IDs own sample and seed data in system:

PRD IDs	Description
ADISPRD	Sample and seed data owner for Advancement.
FAISPRD	Sample and seed data owner for Financial Aid.
FIMSPRD	Sample and seed data owner for Finance.
GENLPRD	Sample and seed data owner for General.
HRISPRD	Sample and seed data owner for Human Resources.
LIMSPRD	Obsolete.
MICRPRD	Obsolete.
POSNPRD	Sample and seed data owner for Position Control.
SAISPRD	Sample and seed data owner for Student.
TAISPRD	Sample and seed data owner for Accounts Receivable.

The following are schema, object owners, etc.:

Other IDs	Description
ADISDAT	Advancement data user.
ALUMNI	Advancement schema owner.
BANIMGR	Banner Document Management Suite schema owner.
BANINST1	Owner of most product packages, functions and procedures.
BANSECR	Security schema owner.
BASELINE	Special user for certain SunGard-delivered data.

Note: The BASELINE ID is not delivered.

Other IDs	Description
BWAMGR	Advancement Self-Service schema owner.
BWFMGR	Finance Self-Service schema owner.
BWGMGR	Web General schema owner.
BWLMGR	Faculty Self-Service schema owner.
BWPMGR	Employee Self-Service schema owner.
BWSMGR	Student Self-Service schema owner.
FAISDAT	Financial Aid data user.
FAISMGR	Financial Aid schema owner.
FIMSARC	Finance archive user.
FIMSDAT	Finance data user.
FIMSMGR	Finance schema owner.
GENERAL	General schema owner.
HRISDAT	Human Resources data user.
ICMGR	Integration components schema owner.
MICROFA	Obsolete.
MICRPRD	Obsolete.
NLSUSR	Integration Manager schema owner.
PAYROLL	Payroll schema owner.
POSNCTL	Position Control schema owner.
SAISDAT	Student data owner.
SATURN	Student schema owner.
TAISMGR	Accounts Receivable schema owner.
VRSMGR	Voice Response Student and Financial Aid schema owner.
WFAUTO	Automated activities for a Workflow account.
WFEVENT	Event Queue Manager for a Workflow account.
WFQUERY	Query-only Workflow account.
WTAILOR	Web Tailor schema owner.

To generate a list of these user IDs in Oracle, enter the following command:

```
select username from dba_users order by username;
```

For security purposes, the schema owners and BANINST1 user accounts can be locked or have their passwords changed to prevent anyone from using these accounts during regular processing.

BASELINE and LOCAL User IDs

Many General tables have been assigned a user ID of either BASELINE or LOCAL. The reason for this user ID column is simple: SunGard needed a way to clearly identify our deliverable rows versus your custom rows so that when we re-deliver software in subsequent versions we do not interfere with your custom rows.

BASELINE rows should not be changed without careful consideration of your future need to maintain these rows. If you find it necessary to change BASELINE rows, you can create a user with the name of BASELINE and the class of General objects. This BASELINE user would then be able to log into Banner and make changes to the BASELINE rows.

Places where you will find this most helpful are in initial set up of the standard toolbar icons and when you need to make changes to the options in the navigation frame.

Directory Structure

ADMIN

OPSYS	Contains COBOL make files for platform (UNIX, AIX, DGUX, SUNOS, etc.)
-------	---

ALUMNI (Banner Advancement)

C	Pro*C and C source files
COM	DCL command files (VMS only)
DBPROCS	SQL*Plus scripts to recreate database procedures, packages, functions, and triggers
FORMS	Oracle*Forms .fmb, .fmx, .pll, and .lib files
INSTALL	.SCTDMP file used during the initial install (renamed to .DMP during install)
MISC	Shell scripts (UNIX only)
PLUS	SQL*Plus scripts
VIEWS	SQL*Plus scripts to recreate views

ARSYS (Banner Accounts Receivable)

C	Pro*C and C source files
COB	Pro*COBOL files (UNIX only)
COBPCO	Pro*COBOL files (VMS only)

ARSYS (Banner Accounts Receivable)

COM	DCL command files (VMS only)
DBPROCS	SQL*Plus scripts to recreate database procedures, packages, functions and triggers
FORMS	Oracle*Forms .fmb, .fmx, .pll and .lib files, Oracle Reports
INSTALL	.SCTDMP file used during initial install (renamed to .DMP during install)
MISC	Shell scripts (UNIX only)
PLUS	SQL*Plus scripts
VIEWS	SQL*Plus scripts to recreate views

COMMON

Objects shared by all products (see Chapter 5)

FINAID (Banner Financial Aid)

C	Pro*C and C source files
COB	Pro*COBOL files (UNIX only)
COBPCO	Pro*COBOL files (VMS only)
COM	DCL command files (VMS only)
DBPROCS	SQL*Plus scripts to recreate database procedures, packages, functions and triggers
FORMS	Oracle*Forms .fmb, .fmx, .pll and .lib files
INSTALL	.SCTDMP file used during initial install (renamed to .DMP during install)
JAVA	Files that contain Java code
MISC	Shell scripts (UNIX only)
PLUS	SQL*Plus scripts
VIEWS	SQL*Plus scripts to recreate views

FINANCE (Banner Finance)

C	Pro*C and C source files
COM	DCL command files (VMS only)
DBPROCS	SQL*Plus scripts to recreate database procedures, packages, functions and triggers
DESKTOP/EDI	EDI Desktop Application
FORMS	Oracle*Forms .fmb, .fmx, .pll and .lib files, Oracle Reports
INSTALL	.SCTDMP file used during initial install (renamed to .DMP during install)
MISC	Shell scripts (UNIX only)
PLUS	SQL*Plus scripts
IEWS	SQL*Plus scripts to recreate views

GENERAL (Banner General)

C	Pro*C and C source files, C compile procedures, EXEC INCLUDE files (source files)
COB	COBOL copybooks for all products (UNIX also includes General Pro*COBOL & .gnt files)
COB/LIB	Links to copybooks with .cob extension and lower case names (UNIX only)
COBPCO	Pro*COBOL files (VAX/VMS only)
COM	DCL command files (VAX/VMS only)
DESKTOP	Desktop executable
DBPROCS	SQL*Plus scripts to recreate database procedures, packages, functions and triggers
EXE	Compiled PRO*COBOL executables for all products
FORMS	Oracle*Forms .fmb, .fmx, .mmb (menus), .mmx, .pll (PL/SQL library) and .lib (library) files
GIF	Banner GIFs

GENERAL (Banner General)

INSTALL	.SCTDMP file used during initial install (renamed to .DMP during install)
JAVA	Files that contain Java code
LOADER	Oracle*Loader
MISC	Shell scripts (UNIX only)
PLUS	SQL*Plus scripts
VIEWS	SQL*Plus scripts to recreate views
XSD	Oracle schemas

INSTALL

All Banner installation scripts

LINKS (UNIX Only)

Composite directory for local access of Banner products

PAYROLL (Banner Payroll)

C	Pro*C and C source files
COB	Pro*COBOL files (UNIX only)
COBPCO	Pro*COBOL files (VMS only)
COM	DCL command files (VMS only)
DBPROCS	SQL*Plus scripts to recreate database procedures, packages, functions and triggers
DESKTOP	Doc files
FORMS	Oracle*Forms .fmb, .fmx, .mmb (menus), .mmx, .pll and .lib files
INSTALL	.SCTDMP file used during initial install (renamed to .DMP during install)
MISC	Shell scripts (UNIX only)

PAYROLL (Banner Payroll)

PLUS	SQL*Plus scripts
VIEWS	SQL*Plus scripts to recreate views

POSNCTL (Banner Position Control)

C	Pro*C and C source files
DBPROCS	SQL*Plus scripts to recreate database procedures, packages, functions and triggers
FORMS	Oracle*Forms .fmb and .fmX files
INSTALL	.SCTDMP file used during initial install (renamed to .DMP during install)
MISC	Shell scripts (UNIX only)
PLUS	SQL*Plus scripts
VIEWS	SQL*Plus scripts to recreate views

STUDENT (Banner Student)

C	Pro*C and C source files
COB	Pro*COBOL files (UNIX only)
COBPCO	Pro*COBOL files (VMS only)
COM	DCL command files (VMS only)
DBPROCS	SQL*Plus scripts to recreate database procedures, packages, functions and triggers
FORMS	Oracle*Forms .fmb, .fmX, .pll and .lib files, Oracle Reports
INSTALL	.SCTDMP file used during initial install (renamed to .DMP during install)
JAVA	Files that contain Java code
LOADER	Oracle*Loader
MISC	Shell scripts (UNIX only)

STUDENT (Banner Student)

PLUS	SQL*Plus scripts
VIEWS	SQL*Plus scripts to recreate views

COBOL Standards

It is difficult to fully document exactly how a Banner COBOL program is to be written. Many factors influence the particular programming approach that should be followed to satisfy specific requirements. This section gives some guidelines and recommendations which should be followed when an existing Banner COBOL program is modified or a new one created.

These guidelines are divided into three sections: Rules, Standards, and Style. Rules should always be followed; standards should be followed unless there is a demonstrable need to do otherwise; and styles are recommendations.

In general, rules address operating system portability, ANSI compliance, and Oracle version compatibility. Standards enhance the maintainability of the code. Style relates primarily to the appearance of the COBOL source code.

Rules

This rule applies only to those programs that perform a connect to an Oracle database.

Banner COBOL programs must make use of some of the General support objects in order to gain access through the security routines. Two include files (also referred to as copybooks) are required, and a Working Storage variable must be initialized. Additionally, the program should be able to be compiled with the “sqlcheck= full” option. In certain circumstances however, this is not possible. For example, GLBLSEL.pco cannot be compiled in this manner at sites which do not have Financial Aid since the program references the RORVIEW TABLE. Compiling with “sqlcheck= full” in this case would result in an error.

The first required include file is SETSEED. This must be placed immediately before the EDECLARE include file, or, if EDECLARE is not used, immediately before the END DECLARE statement in Working Storage. For example:

```
EXEC SQL INCLUDE SETSEED END-EXEC.  
EXEC SQL INCLUDE EDECLARE END-EXEC.
```

The variable `OBJECT-NAME` is declared in SETSEED, and must be initialized just prior to the include of the second include file that is required for security processing, SETROLE.

The variable initialization and include statement must be placed immediately after the connect to Oracle, as shown in the example below:

```
EXEC SQL
CONNECT :USERID IDENTIFIED BY :PASSWRD
END-EXEC.
MOVE '<program name>' TO OBJECT-NAME.
EXEC SQL INCLUDE SETROLE END-EXEC.
```

After ensuring that the above files are included, the program should be compiled with the “sqlcheck=full” option.

Comment lines between logically grouped blocks of COBOL sentences are encouraged as they make the program easier to read. Every comment line must contain an asterisk in column 7. In other words it must be officially designated as a comment line. Certain compilers yield a syntax error if they encounter a blank line that is not truly a comment line.

```
215-8 *
215-8 3800-DELETE-ALL-FROM-NHRFINC.
215-8 MOVE '3800' TO ABORT-PARA.
215-8 *
215-8 EXEC SQL
215-8 DELETE FROM NHRFINC
215-8 WHERE NHRFINC_CATEGORY_CODE BETWEEN 'A' AND 'J'
215-8 AND NHRFINC_INTERFACED_IND = 'Y'
215-8 END-EXEC.
215-8 *
215-8 EXEC SQL COMMIT WORK END-EXEC.
215-8 *
215-8 3800-EXIT.
215-8 EXIT.
```

When declaring variables in **WORKING-STORAGE**, the word **PICTURE** must be spelled out fully as opposed to using the **PIC** abbreviation. Some compilers do not accept the abbreviation.

```
WORKING-STORAGE SECTION.
EXEC SQL BEGIN DECLARE SECTION END-EXEC.
01 MISC-DECLARE-SECTION-VARIABLES.
05 USERIDPICTURE X(20).
05 PASSWRDPICTURE X(20).
05 CONTROL-DISPPICTURE X(02) VALUE '60'.
05 UPDATE-DISPPICTURE X(02) VALUE '62'.
05 WORK-DATEPICTURE X(11).
```

Literals should be enclosed in single quotes ('xxx') instead of double quotes (“xxx”). This applies to the **VALUE** clause in **WORKING-STORAGE** (as shown above) as well as literals used in the **PROCEDURE DIVISION**.

```
*=====
* Added the following logic to determine if an automatic
* login is being used, and if so, set up the field values
* required for an automatic login.
*=====
IF EACH-PARM (2) = '/'
MOVE '/' TO DQY-AUTO-LOGIN-ARR
IN DQY-AUTO-LOGIN
MOVE 1 TO DQY-AUTO-LOGIN-LEN.
*
```

Standards

All changes to a program should be recorded in the Audit Trail section at the top of the program directly before the ENVIRONMENT DIVISION statement. The Audit Trail follows a particular format which includes the sequential number of the modification within a release, a description of the change, the programmer's initials and the date. It should be preceded with a brief description of the purpose of the program.

```
*****
* This is the Population Selection extract program. It will
* create a list of PIDMs for a given selection ID, which can
* be used as input to the Letter Generation extract, or other
* reports.
*****
* AUDIT TRAIL: x.x
*
* 1. SJQ 05/14/1991
*   RENAME PROGRAM NAME TO UPPERCASE.
* 2. JEF 05/31/91
*   Rename ROBDATA to GLBDATA and add letter generation
*   modifications.
*
```

More recently, an alternative technique has been employed whereby the Audit Trail entry includes a Problem or Need statement, a Functional Impact and a Technical changes statement.

```
* 2. RPM # 475. RLP 01/04/96
*   Need - Computer Calculated Manual Checks should
*         default to disposition '40'.
*   Functional Impact - User no longer will have to balance
*                     computer calculated events that
*                     have been processed by PHPCALC.
*                     Immediately after PHPCALC has been
*                     run, the user can now run PHPDOC.M.
*
*   Technical changes - All references to a disposition of '37'
*                     have been removed or changed to '40'.
*
*
```

Each line of code that is affected by a particular modification should contain a “Mark Mod” in columns 1 through 6 which indicates the release and sequential number of the change. For example, the first modification in the program for release 2.1.7 would be marked with 217-1 in columns 1 through 6. This is extremely useful when trying to fully track how, when and why a certain line of code was changed. The following code includes lines affected by the tenth modification of the 2.0 release and the seventh modification of the 2.1.5 release:

```
IF DQY-ERROR-TYPE = 'F'
    EXEC SQL ROLLBACK WORK END-EXEC
    MOVE DQY-ERROR-MSG TO GJBRSLT-MESSAGE
    MOVE SPACES TO DQY-ERROR-MSG,
    DQY-ERROR-TYPE
    MOVE 'F' TO GJBRSLT-STATUS-IND
20-10 PERFORM DQY-INS-GJBRSLT THRU DQY-INS-GJBRSLT-EXIT
215-7 EXEC SQL COMMIT WORK END-EXEC
    PERFORM DQY-ABORT THRU DQY-ABORT-EXIT.
```

Each program should include a display statement up front in the logic of the format Starting <program_name> (Release x.x.xx). The release number must be updated with each release for which the program is modified. This gives a clear and easy way to verify that the correct program and version of that program is being executed.

```

2000-SIGN-ON-TO-DBMS.
      MOVE '2000' TO ABORT-PARA.
13-14  DISPLAY ' '.
217-1  DISPLAY 'Starting PHPFEXP (Release 7.1.1)'.
      DISPLAY ' '.
      DISPLAY 'Username: '.
      ACCEPT USERID.
      MOVE SPACE TO WS-LOWER-CASE
      WS-UPPER-CASE.

```

Certain versions of the COBOL compiler behave differently with respect to command line parameters and accepting data from the console (terminal). To accommodate these differences, it was necessary to provide for a “dummy ACCEPT” statement as the first ACCEPT in the program. A pre-compile definition of “SCT001” is used in conjunction with the standard Banner compile scripts to allow control of whether this dummy ACCEPT is needed or not. Only when the SCT001 parameter is defined for the pre-compiler will the dummy ACCEPT end up in the executable code. It is recommended that these first three lines of code be included in all programs.

```

10000-ENTER-PROGRAM.
20-14  EXEC ORACLE IFDEF SCT001 END-EXEC.
      ACCEPT WS-DUMMY-ITEM FROM USER-INPUT-DEVICE.
20-14  EXEC ORACLE ENDFIF END-EXEC.
217-3  *
217-3  MOVE SPACES TO GJBRSLT-FIELDS.
217-3  PERFORM 11000-RETRIEVE-ONLINE-PARMS THRU 11000-EXIT.

```

Style

Care should be taken when lining up and indenting WORKING-STORAGE variable definitions. It is much easier on the eye and is more conducive to understanding the program when one does not have to struggle with confusing formatting that makes it difficult to discern the level relationships between variables.

How it **should** be done:

```

20-9  01 FRINGE-CHARGE-BACK-WORK-AREA.
20-9    05 FBLD-HIT-SW                PIC X(02).
20-9    05 FBLD-QUERY-DATE            PIC S9(07) COMP-3.
20-9    05 FBLD-COAS-CODE             PIC X(01).
20-9    05 IO-NTRFBIN-RATE            PIC S9(04)V999 COMP-3.
20-9    05 IO-NTRFBEX-RATE            PIC S9(04)V999 COMP-3.
202-2  05 FRINGE-POSTING-MODE        PIC X(01).
202-2  05 FRINGE-INST-AMOUNT         PIC S9(07)V99  COMP 3.
20-9    05 IO-NTRFBEX-FOAPAL.
20-9      07 IO-NTRFBEX-FUND-CODE    PIC X(06).
20-9      07 IO-NTRFBEX-ORGN-CODE    PIC X(06).
20-9      07 IO-NTRFBEX-ACCT-CODE    PIC X(06).
20-9      07 IO-NTRFBEX-PROG-CODE    PIC X(06).
20-9      07 IO-NTRFBEX-ACTV-CODE    PIC X(06).
20-9      07 IO-NTRFBEX-LOCN-CODE    PIC X(06).

```

How it should **not** be done:

```

20-9  01 FRINGE-CHARGE-BACK-WORK-AREA.
20-9  05 FBLD-HIT-SW PIC X(02).
20-9  05 FBLD-QUERY-DATE PIC S9(07) COMP-3.
20-9  05 FBLD-COAS-CODE PIC X(01).
20-9  05 IO-NTRFBIN-RATE PIC S9(04)V999 COMP-3.
20-9  05 IO-NTRFBEX-RATE PIC S9(04)V999 COMP-3.
202-2 05 FRINGE-POSTING-MODE PIC X(01).
202-2 05 FRINGE-INST-AMOUNT PIC S9(07)V99 COMP-3.
20-9  05 IO-NTRFBEX-FOAPAL.

```

```

20-9 07 IO-NTRFBEX-FUND-CODE PIC X(06).
20-9 07 IO-NTRFBEX-ORGN-CODE PIC X(06).
20-9 07 IO-NTRFBEX-ACCT-CODE PIC X(06).
20-9 07 IO-NTRFBEX-PROG-CODE PIC X(06).
20-9 07 IO-NTRFBEX-ACTV-CODE PIC X(06).
20-9 07 IO-NTRFBEX-LOCN-CODE PIC X(06).

```

The care needed for **WORKING-STORAGE** indentation applies similarly to the **PROCEDURE DIVISION**. It is best to illustrate with examples:

```

PERFORM 2000-SIGN-ON-TO-DBMS THRU 2000-EXIT.
        PERFORM 3000-GET-PARAMETERS THRU 3000-EXIT.
215-8 *
215-8     PERFORM 4100-INITIALIZE-CAT-TOTALS THRU 4100-EXIT
215-8     VARYING CAT-SUB FROM 1 BY 1
215-8     UNTIL CAT-SUB > CAT-MAX.
215-8 *
215-8     MOVE ZEROS TO LIQUIDATION-TOTAL-D
215-8     LIQUIDATION-TOTAL-C.
215-8 *
215-8     IF PARM-ALL-PAYROLLS = 'Y'
215-8     IF PARM-PICT-CODE = SPACES
215-8     PERFORM 3410-DECLARE-AND-OPEN-PAYS-1 THRU 3410-EXIT
215-8     ELSE
215-8     PERFORM 3420-DECLARE-AND-OPEN-PAYS-2 THRU 3420-EXIT
.
.
.
215-7     WHERE HRHIST_PAYNO = PHRJOBS_PAYNO
215-7     AND PHRHIST_PIDM = PHRJOBS_PIDM
215-8     AND ((:PARM-REDIST-ONLY = 'N')OR
215-8     (PHRHIST_TYPE_IND = 'R') OR
215-8     (PHRHIST_TYPE_IND = 'V' AND
215-8     'R' =
215-8     (SELECT PHRHIST_TYPE_IND
215-8     FROM PHRHIST Y
215-8     WHERE Y.PHRHIST_YEAR = X.PHRHIST_YEAR
215-8     AND Y.PHRHIST_PAYNO = X.PHRHIST_PAYNO
215-8     AND Y.PHRHIST_PIDM = X.PHRHIST_PIDM))

```

Paragraph names should use a numbering scheme that communicates the structural hierarchy of the **PROCEDURE DIVISION** logic. For example, all initial housekeeping paragraphs might be grouped in the 1000- to 1900- range. The parameter input logic might be grouped in the 2000- to 2900- range and so on. A structure based on letters can also be used (AAA1-, AAA2-, ABB1- etc.)

All paragraphs should have an exit and the perform of a paragraph should always be “**THRU**” the exit.

```

3000-INITIALIZATION-CONTROL.
        PERFORM 4100-INITIALIZE-CAT-TOTALS THRU 4100-EXIT.
3000-EXIT.
EXIT.

4100-INITIALIZE-CAT-TOTALS.
        MOVE ZEROS TO CATEGORY-TOTAL-1,
CATEGORY-TOTAL-2.
.
.
.
4100-EXIT.
EXIT.

```

C Standards

Introduction

There is no simple answer to the question, “What is the correct or appropriate way to write a C program?” The factors that influence the programming approach range from the global (such as, how to write for maximum operating system portability) to the trivial (such as, how to indent blocks of code). This section gives some recommendations for C code developed as part of the Banner system.

These guidelines are divided into three sections: Rules, Standards, and Style. The differences between the three are as follows: rules should always be followed; standards should be followed unless there is a demonstrable need to do otherwise; and styles are recommendations which an individual programmer may choose to discard. In general, items dealing with operating system portability, ANSI compliance, Oracle version compatibility, and avoidance of common errors will be treated as rules, while those whose primary purpose is to enhance maintainability of the code will be standards. Style relates primarily to the appearance of the C source code, and the guidelines given here describe one programmer's approach to this issue; the goal with the style guidelines is not to be prescriptive, but rather to provide guidance for novice C programmers.

Note that the Banner C coding standards are evolving and subject to change. Most Banner Pro*C code originated as Oracle SQL*Report code that was converted to Pro*C using an automated process, and as a result may not conform to all of the rules and standards in this section; particularly, this code is rife with the goto statement. Subsequent code was developed over a period of years as SunGard's C standards were evolving, and so once again not every program delivered by SunGard Higher Education meets the rules and standards below.

Rules

1. Adherence to the ANSI C standard is paramount; any exceptions are noted below. A copy of *The C Programming Language, 2nd Edition*, by Brian Kernighan and Dennis Ritchie, should be standard equipment for any programmer writing or modifying Banner C code.
2. All variable declarations global to the current compilation unit, function declarations, and function prototypes must include the storage class modifier `static` unless they need to be available for external linkage. Global variables and function declarations are, by default, external. To support proper modularity, each program unit should only make external those functions and variables which have been determined to be necessary for other code units to access.

```
/* global variables with external visibility */  
char username_password[62];  
unsigned int status_code;
```

```

/* global variables visible only in current compilation unit */
static FILE *infile,*outfile;
static long line_count=0;

```

3. All functions must be fully prototyped, following ANSI standards, either in a header file (if accessed by more than one source file) or at the top of the source file where it is declared. A complete prototype consists of the return type of the function, the function name, and the types of each parameter, along with the formal parameter names. As a matter of style, the prototype should exactly match the actual function declaration, e.g.:

```

char *str2lc(char *str);
.
.
char *str2lc(char *str)
{
...
}

```

4. The goto statement should never be used in new C code and should be removed from all existing code when possible; this also eliminates any need for labels. Use structured programming techniques instead.

```

/* parameter validation code with gotos and labels */
askparms:
    input(ask_p_owner,"TABLE CREATOR: ",30,ALPHA);
    if ( !*ask_p_owner ) goto rdowner;
    strcpy(p_owner,ask_p_owner);
    goto nexta;
rdowner:
    strcpy(parm_no,"01");
    sel_optional_ind(FIRST_ROW);
    if ( compare(rpt_optional_ind,"0",EQS) ) goto nexta;
    goto missing_parms;
nexta:

/* parameter validation code without gotos and labels */
input(ask_p_owner,"TABLE CREATOR: ",30,ALPHA);
if ( !*ask_p_owner )
{
    strcpy(parm_no,"01");
    sel_optional_ind(FIRST_ROW);
    if ( compare(rpt_optional_ind,"0",NES)
missing_required_parm("Table Creator");
}

```

5. All programs should include guastdf.h, and only this file should include standard headers. This will limit the number of changes necessary for new compilers or hardware platforms and will insure that all necessary headers are included. Note that guarpfe.h includes guastdf.h, so an explicit inclusion is not necessary.

```

#include "guarpfe.h" /* good; gets all required headers */
#include "myheader.h" /* good; local header */
#include <sys/strtty.h> /* bad; non-portable, system-specific */

```

6. No compiler or platform specific functions may be used. Only those functions found in the ANSI standard libraries are available on all supported platforms. Exceptions to this rule, such as the use of the UNIX and OpenVMS provided function sleep, may be made with management approval. Refer to The C Programming Language, 2nd

Edition, by Brian Kernighan and Dennis Ritchie, for a definitive listing of the functions available.

7. The following ANSI features are not available under otherwise compliant compilers, such as older versions of DEC C, and are not to be used unless all supported compilers implement them in the future: the `atexit` and `memmove` functions, concatenation of adjacent string literals, and `##` macro expansion. Also, an assignment followed by the “address of” or “dereference” operator with no intervening space, is misinterpreted by some releases of DEC C. Accordingly, use

```
a= *b;
```

instead of

```
a=*b;
```

Finally, DEC C requires that `main` be of type `int` and return a value to the operating system.

```
int main(int argc,char *argv[]) /* suggested portable declaration of
main */
```

8. All handling of file names from the operating system is done with the `makefn` and `parsfn` functions defined in `guastdf.h` to provide maximum code portability.

```
FNSTRUC outfile;
.
.
.
strcpy(outfile.fname,*argv);
parsfn(&outfile);
strcpy(outfile.ext,"lis");
makefn(&outfile);
```

9. All programs should use the function `exit2os`, defined in `guastdf.h`, to return to the operating system; this will ensure that all necessary database and memory cleanup is performed. Application code should never use the standard function `exit`. Also, application code should never reach a return from within the `main` function; however, to prevent warnings from some compilers, the `exit2os` call at the bottom of `main` should be immediately followed by a return.

```
int main(int argc,char *argv[])
{
    /* all done */
    exit2os(EXIT_SUCCESS);
    return 0;
}
```

10. All Pro*C programs must include the file `guaorac.c` and use the provided database utility functions for database connection and disconnection, and use the macro `POSTORA` to check for database errors. This will insulate code from future changes to Pro*C internals and provide a common interface to the database for all programs. Most importantly, the `login` function must be used to connect to the database with Banner security enabled.

```
/* minimal.pc */
#include <guastdf.h>
```

```

EXEC SQL INCLUDE guaorac.c;
int main(int argc, char *argv[])
{
    CHAR31 myname;
    /* necessary for security in absence of rptopen */
    getxnam(*argv);
    /* login to database with three tries */
    login();

    EXEC SQL SELECT user INTO :myname FROM dual;

    /* check for error */
    POSTORA;
    printf("Logged on to Oracle as %s\n", myname);
    /* does database exit, other cleanup */
    exit2os(EXIT_SUCCESS);
    return EXIT_SUCCESS;
}

```

11. All application and support code should Pro*C pre-compile and C compile with no warnings or errors on all supported platforms. Following ANSI standards eliminates the majority of problems, but certain compilers may be more restrictive than others. For example, when using the Pro*C pseudo-datatype VARCHAR, it is necessary to explicitly typecast the arr member to a character pointer in standard function calls under some compilers. In short, when in doubt, cast.

12. All Pro*C programs should recognize the -t command-line switch to turn on the SQL trace facility. Programs converted by SunGard from earlier Oracle SQL*Report code use rptopen to handle this option.

```

int main(int argc, char *argv[])
{
    extern short sqltrace_flag;
    rptopen(user_pass, argc, argv);
    login();
    if ( sqltrace_flag )
    EXEC SQL ALTER SESSION SET SQL_TRACE TRUE;
}

```

13. Many C compilers allow modification of literals by means of pointers; this is not allowed in SunGard C code. Consider the following code:

```

...
char *ptr="SCT";
*ptr = '\0';
...

```

Here ptr points to an area of storage containing the string literal "SCT", which may not be unique storage if the same literal appears elsewhere in the program. Modifying the storage pointed to by ptr may work as expected, but if the new value assigned to ptr is longer than the original literal area, then memory errors will occur. Also, some compilers will signal an error or warning message if such an operation is attempted.

14. Always check error status after any I/O or database operation. The guastdf.h include file defines the macro POSTORA to make Oracle error checking simpler, and all file I/O operations should be followed by a check using the ferror standard function.

```

EXEC SQL SELECT ename
        INTO :ename:ename_ind
        FROM emp
        WHERE empno = :empno;
POSTORA;
fprintf(outfile, "%d:%s\n", empno, ename);

```

```
if ( ferror(outfile) )
    prtmsg(IOERROR,outfile_name);
```

- 15.** Functions which return a pointer to a local variable must give the static storage class to the return variable. If the keyword `static` is not supplied, then the storage for the local variable may be reused by the program before the calling function is able to access the address. This is a common error which is rarely caught by the compiler or tools such as `lint`, and may even work correctly on some machines, depending on the way that the memory heap is managed.

For example, consider a function that generates a new password string and returns a pointer to the new value. The calling function will then copy this value elsewhere for storage, as the value will be lost when the password function is next called.

```
char *getpassword(void)
{
    static char passval[9];
    .
    .
    .
    return passval;
}
```

- 16.** Indicator variables must be used on all SQL output variables, and on all non-string input variables (unless a non-NULL value is guaranteed.) This is to prevent truncation warnings when the target is too small for the source, and to properly handle NULL values. See Rule 14 for an example.

- 17.** Complex structures which will be reused should be typedefed in order to simplify and clarify the code. For example, consider the structure and declarations for implementing a linked list of file information:

```
typedef struct fn_node_struct
{char *fname;
 char *owner;
 unsigned long fsize;
 struct fn_node_struct *next_fn_node;} FN_NODE;
FN_NODE *head,*tail;
```

- 18.** Use Oracle datatype equivalencing to handle C-style null-terminated strings in preference to the `VARCHAR` pseudo-datatype. All C code originally converted by SunGard from Oracle SQL*Report code uses this method, as does most subsequent Banner code uses this method. The include files `guastdf.h` and `guaorac.c` provide predefined typedefs for string sizes from 2 to 256 characters in length (1 to 255 usable characters plus the terminating null); if a particular application requires longer strings, or strings embedded within arrays, then use explicit Pro*C `TYPE IS` and `VAR IS` logic (see the Programmer's Guide to the Oracle Pro*C Precompiler for details).

```
/* Without datatype equivalencing */
VARCHAR zipcode[11];
.
.
.
EXEC SQL SELECT zipcode
        INTO :zipcode:zip_ind
        FROM address
        WHERE empno = :empno;
POSTORA;
zipcode.arr[zipcode.len] = '\0';
/* With datatype equivalencing */
CHAR11 zipcode;
```

```

.
.
EXEC SQL SELECT zipcode
          INTO :zipcode:zip_ind
          FROM address
          WHERE empno = :empno;

```

19. Use the appropriate numeric datatype for the application, keeping in mind the limitations of each. The basic choices are a C integer type, a C floating-point type, or the SunGard-provided pseudo-datatype of NUMSTR.

Integers are limited to whole numbers only, and in comparison to the Oracle internal NUMBER datatype have a small number of significant digits. A C integer datatype (e.g., long, unsigned int) should only be used as a SQL input/output variable if the Oracle column is a whole number that will never be larger/smaller than the ANSI-defined range for the C datatype. For example, the ANSI-defined minimal magnitudes for a long datatype are -231 to 231-1 (approximately +/- two billion). Integer data types may be appropriate for database columns such as counters and sequences.

Floating-point numbers in C have a minimum of 10 significant digits in the ANSI standard. This limitation makes them inappropriate for most currency calculations. However, all Banner-supported platforms currently have at least 15 digits of precision for the double datatype, so using double as an SQL input-output variable is acceptable provided that the database column in question is known to never exceed 15 digits. This precision should be adequate for nearly all calculations involving U.S. currency, but may be inadequate for non-U.S. currency transactions.

All C codeconverted by SunGard from Oracle SQL*Report code, and much code written subsequent to the conversion, uses the NUMSTR pseudo-datatype in order to provide a guaranteed 24 digits of precision. This datatype is implemented by representing numbers as fixed character strings, and only the four basic arithmetic operators are provided; more elaborate calculations must be performed in the database. The advantages of this datatype are the increased precision, and the elimination of the need for indicator-variable processing (since empty strings are interpreted by Oracle as NULLs.)

Standards

1. A consistent system for naming variables may be mandated by individual technical managers (e.g., so-called Hungarian notation). If a system is not used, then at minimum variable and function names should be long enough to be descriptive, but not so long as to interfere with a clear understanding of the code.
2. SunGard Pro*C programs which were converted from Oracle SQL*Report code have all variables created as globals within the compilation unit, a required strategy since SQL*Report provided only global variables. With new code, or modifications to converted code, good structured programming techniques dictate the usage of local variables as a general rule, with global variables reserved for those occasions when they are necessary to prevent excessively complex or awkward code.

3. If a function in one of the SunGard support files (such as `guastdf.h`) is available to perform the task at hand, use it instead of creating a new one. Likewise, if a function is developed which is of general utility (such as string or number handling, I/O functions, etc.) then it should be placed in one of the support files to be available for all Banner code.
4. Functions, macros, etc. which extend the language (i.e., support code such as that found in `guarpfe.h` or `guastdf.h`) should be named mnemonically, without regard to product. For example, the function to replace a string with its lower case equivalent is named `str2lc`. The name of any other program object which will be used by multiple programs within a specific product should be named following usual Banner rules for the initial character. For example, a Finance function to calculate available balance could be named `favlbal`.
5. Do not depend on the numeric value of a particular macro remaining unchanged or always testing to true or false. Instead, compare the value in question with the current value of the macro. There are exceptions, such as the `TRUE` and `FALSE` macros in `guastdf.h`, where the numeric value will always remain unchanged.

```
#define OS_VMS 0
#define OS_UNIX 1
#define OS_NT 2
.
.
.
/* don't do this */
if ( opsys )
    printf("Operating system is UNIX or Windows NT\n");
/* do this instead */
if ( opsys==OS_UNIX || opsys==OS_NT )
    printf("Operating system is UNIX or Windows NT\n");
```

6. The general structure of a C program should be as follows:

```
#include ... /* header file includes */
EXEC SQL INCLUDE ... /* Pro*C includes */
#define ... /* macro definitions */
static void my_fcn(void); /* function prototypes */
static int flag; /* non-ORACLE globals */
EXEC SQL BEGIN DECLARE SECTION /* ORACLE globals */
int main(...) /* the function main */
static void my_fcn(void) /* all other functions */
```

Functions should be defined in some logical order, such as alphabetic or by purpose.

7. Variables which are initialized at declaration time should appear on separate lines; e.g.:

```
static int flag=TRUE,error=FALSE;
```

should be written as:

```
static int flag=TRUE,
        error=FALSE;
```

8. Every function or other major block of code (blocks of prototypes, variable declarations, etc.) should be preceded by explanatory comments.

9. Names of macros and type definitions should usually be in all capitals to clearly differentiate them from functions and standard C features.
10. Procedural macros should not include a closing semicolon, which should instead be coded when the macro is invoked. Many programmers code macros which are not enclosed in braces with a closing semicolon, but the resulting invocation can look confusing, as a line of code without the semicolon looks “incomplete” when scanning the code.

```
#define POSTORA if ( sqlca.sqlcode < 0 ) dberror(__FILE__,__LINE__)
:
:
POSTORA;
```

11. Explicit SQL cursors should be closed when they are no longer needed. This may be very difficult to ascertain for converted code, but new development should follow this standard.
12. Cursor names should be descriptive. The generated Pro*C programs use one-up numeric cursor names, but new programs should be more clear.

```
EXEC SQL DECLARE retrieve_name CURSOR FOR
SELECT ename
FROM emp;
```

13. Consider the use of array fetches to improve the performance of programs which retrieve a large number of rows from the database. Refer to the Programmer's Guide to the Oracle Pro*C Precompiler for details.
14. All messaging for any functions added to the support code files should be handled by prtmsg, with the actual message text added to guaerror.h.
15. Keep it simple. It is easy to write cryptic, code that cannot be maintained in C; however, other programmers may need to maintain your code in the future.
16. Again, keep it simple, but not too simple. Become familiar with common C constructs and the functions available through the standard libraries. For example, here are two versions of a function that changes all occurrences of one character in a string to another character. Both functions provide correct output, but the second is “better” because it uses standard C functions and conventions to accomplish the task.

```
/* "Bad" version of chgchar */
char *chgchar(char *str,char oldc,char newc)
{
    int i;
    if ( strcmp(str,"\0") == 0 )
        printf("String is empty\n");
    else
        for ( i=0 ; str[i] != '\0' ; i++ )
            if ( str[i] == oldc )
                str[i] = newc;
    return str;
}

/* "Good" version of chgchar */
char *chgchar(char *str,char oldc,char newc)
{

```



```

char *p=str-1;
if ( !*str )
    printf("String is empty\n");

else
    while ( (p=strchr(p+1,oldc)) != NULL )
        *p = newc;
return str;
}

```

17. The SQL DECLARE SECTION syntax is now optional. With Pro*C 2.x and above all C code is parsed, so variables declared anywhere in the program, including standard declarations, function parameters, and macro expansions, are available for use as both input and output variables in SQL code. Since it is still a good idea to group variables by function, existing code may continue to use a declare section.

Style

1. Be consistent; whatever style for commenting, indentation, etc., is used in a program, use the style consistently throughout the program.
2. Wherever any purely stylistic guideline interferes with the readability of the code, ignore it. The only purpose of a programming style is to enhance, not diminish, the maintainability of the program.
3. Begin functions at the left margin, with the opening and closing braces flush against the margin. All code is indented two spaces. Subsidiary blocks of code, such as targets of if statements, are likewise indented two spaces.

```

char *str2lc(char *str)
{
    char *p;
    for ( p=str ; *p ; p++ )
        if ( isupper(*p) )
            *p = tolower(*p);
    return str;
}

```

4. Where a block of code rather than a single line is used, the opening and closing braces should be lined up in the column for the current indentation, with the contained code indented another two spaces.

```

if (flag)
{
    flag=FALSE;
    if ( str )
    {
        puts(str);
        str = NULL;
    }
}

```

5. Comment thoroughly. Use line comments where applicable (e.g., explaining a variable declaration) and block comments elsewhere. Start block comments with the comment open symbol, one space, and then the first line of the comment. End block comments with a carriage return and a comment close, lined up underneath the comment open. Block comments are also delineated by single blank lines before and after the block.

```
static char *name; /* example line comment */
/* Here is an example of a block comment, defined as a comment which is longer than a
single line.
*/
```

- 6. Avoid extraneous braces in code that is the target of an if or else statement. For example, do not code the following:**

```
if (flag)
{
    puts("TRUE");
}
else
{
    puts("FALSE");
}
```

Instead, code the following:

```
if (flag)
    puts("TRUE");
else
    puts("FALSE");
```

- 7. For complex data structures and type definitions, indent individual members consistently for maximum readability.**

```
typedef struct source_struct
    {char *srcline;
      struct source_struct *next_source;} SOURCE;
```

- 8. For if and other logical statements, when the statement will not fit entirely on one line, break it and indent past the opening parenthesis.**

```
for ( p=head_token ; p && p->type=RPTKEY ;
      p=p->next_token )
    printf("%s\n",p->str);
```

2 Banner Forms



Banner Forms Architecture

This section provides a brief overview of the architecture of Banner and uses three architectural views: logical view, implementation view, and case view. The logical view discusses classes, whereas the implementation view describes certain portions of the code. Lastly, the case view delineates the process by which one can create a form that is compatible with the new standards.

Introduction

To facilitate the discussion in this section of the architecture of Banner, Unified Modeling Language (UML) notation is used to underline the relationship of classes. UML is a formalism that expresses patterns of collaboration between classes and objects. Oracle Forms 6i is not an object-oriented tool; however, the introduction of property classes facilitates the use of object-oriented concepts that better explain the relationships of classes.

Generally, the organizational structure of software is referred to as architecture. Architecture is hereafter represented through 4+1-view model, which is composed of five views: logical view, implementation view, process view, deployment view, and case view.

- The logical view consists of the system's object model: class diagrams, sequence diagrams and collaboration diagrams
- The implementation view gives insights into the code and its organization
- The process view provides information about the interaction of tasks
- The deployment view focuses on the physical architecture of the system
- The case view models interaction between user and system

As mentioned in the objective, only three views will be discussed in this document: the logical view, the implementation view and the case view.

The introduction of object-oriented concepts permits the usage of object-oriented terminology, which has a correspondence in Oracle Forms. (This is not a mere exercise in renaming Oracle Forms terms, but it serves the purpose of drawing a logical connection between object-oriented techniques and Oracle Forms.)

Classes

A class is a blueprint or prototype that defines attributes and methods common to all objects. Classes can also be divided into superclasses and subclasses when an inheritance between classes is performed. Using this definition, the Property Classes of Oracle Forms 6i can be referred to as classes.

Attributes

Attributes define the state of an object. An object is an instance of a class. Its properties are to send and receive messages. In Oracle Forms 6i, each of the properties in a property sheet as well as some variables such as local variables and items within blocks, can be identified as attributes of a class.

Methods

Methods define the behavior of an object. In Oracle Forms 6i, triggers can be referred to as methods.

Objects

Objects are instances of classes. They are formed from the union of state and behavior. They can be best represented by the following:

Object = State + Behavior.

Banner

Banner, as a client application, comprises about two thousand Oracle Forms, modules, or objects. These forms are divided into three families: Validation, Application, and Inquiry. Each family inherits attributes (properties) and methods (triggers) from a superclass, G\$_FORM_CLASS. There are differences in behavior between the three families of forms, which is defined by the methods or triggers in each class.

- The family *Validation*, which is identified by the subclass G\$_VAL_FORM_CLASS, defines a form without a key block and with one or more blocks on which creation, modification and deletion of rows is allowed.
- Alternatively, the family *Application*, which is identified by the subclass G\$_APPL_FORM_CLASS, defines a form with a key block and with one or more additional blocks in which the operations of creation, modification and deletion of rows are allowed.
- The family *Inquiry*, which is identified by the subclass G\$_INO_FORM_CLASS, defines a form with or without a key block where the operations of creation, modification and deletion of rows are not allowed.

In addition to G\$_FORM_CLASS, G\$_VAL_FORM_CLASS and G\$_APPL_FORM_CLASS, G\$_INQ_FORM_CLASS, there are other relevant classes that are discussed in the Logical View.

The Logical View

The logical view offers aspects of the system’s object model, as well as how the classes are composed and related to each other. No collaboration diagrams will be provided in this document.

The Superclass G\$_FORM_CLASS

G\$_FORM_CLASS is a blueprint of a form. This class is a superclass because it is inherited by those subclasses that identify families of forms. As stated previously, a family of forms is a group of related forms that share attributes (fundamental properties) and methods (triggers) of the same superclass. Attributes define the state of a form, while methods define the behavior of a form.

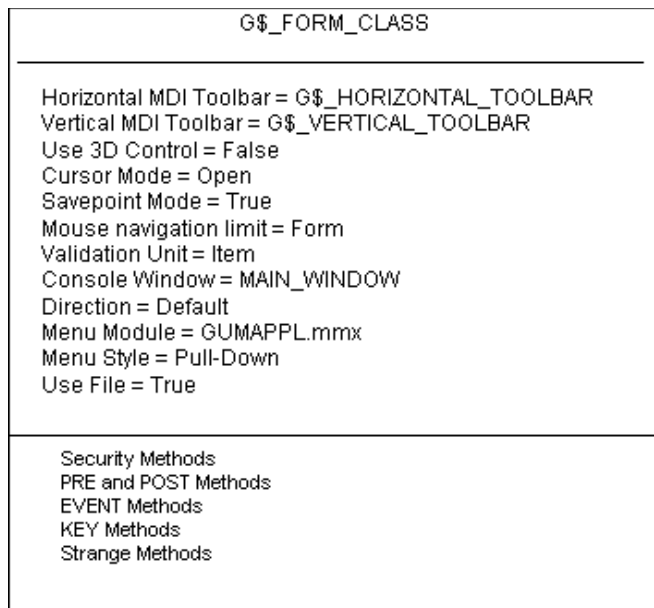

Figure 1: Superclass G\$_FORM_CLASS

Methods

Methods refer to triggers. They are divided into Security, PRE and POST, Event, KEY and Special methods, and are further classified as either form or user-defined triggers.

Security Methods

The following are user-defined triggers that grant and revoke roles in Banner.

G\$_VERIFY_ACCESS
G\$_REVOKE_ACCESS

PRE and POST Methods

The following are navigational and transactional triggers that perform additional processing before or after an event.

PRE-FORM
PRE_FORM_TRG
PRE-BLOCK
PRE_BLOCK_TRG
PRE-INSERT
PRE-UPDATE
POST-FORM
POST_FORM_TRG

Event Methods

The following are triggers that are preformed when a specific event has occurred.

WHEN-BUTTON-PRESSED
WHEN-NEW-FORM-INSTANCE
WHEN-NEW-BLOCK-INSTANCE
WHEN_NEW_BLOCK_INSTANCE_TRG
WHEN-MOUSE-DOUBLECLICK
WHEN-TIMER-EXPIRED
WHEN-WINDOW-ACTIVATED
WHEN_WINDOW_ACTIVATED_TRG
WHEN-WINDOW-CLOSED

KEY Methods

The following are triggers which change the default processing of associated keys on the keyboard.

KEY-CLRFrm
KEY-F2
KEY-MENU
KEY-DOWN
KEY-UP
KEY-LISTVAL
KEY-NXTBLK
KEY-PRVBLK
KEY-NXTREC
KEY-PRVREC
KEY-NXTSET
KEY-SCRUP
KEY-SCRDOWN
KEY-PRINT
KEY-ENTQRY
KEY-EXEQRY
KEY-EXIT
KEY_EXIT_TRG
KEY-NXTKEY
KEY_NXTKEY_TRG

Specialized Methods

The following are user-defined triggers that are used for various purposes.

```
DISPLAY_B2K_HELP_TRG
GLOBAL_COPY
LIST_VALUES_COPY
LOAD_FORM_HEADER
LOAD_CURRENT_RELEASE
SAVE_KEYS
ENABLE_KEYS
DISABLE_KEYS
INVALID_OPTION_MSG
UPDATE_ACTIVITY
```

Subclasses

The subclasses `G$_VAL_FORM_CLASS`, `G$_APPL_FORM_CLASS`, and `G$_INQ_FORM_CLASS` inherit attributes and methods from `G$_FORM_CLASS`. However, these three subclasses possess their own methods, which override the superclass methods.

Subclass `G$_VAL_FORM_CLASS`

The subclass `G$_VAL_FORM_CLASS` is a blueprint of a form without a key block and with one or more blocks in which creation, modification and deletion of rows is allowed.

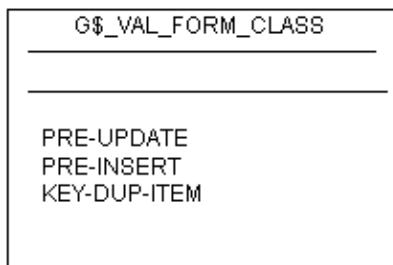

Figure 2: Subclass `G$_VAL_FORM_CLASS`

Subclass `G$_APPL_FORM_CLASS`

The subclass `G$_APPL_FORM_CLASS` defines a form with a key block and with one or more blocks on which the operations of creation, modification and deletion are allowed.

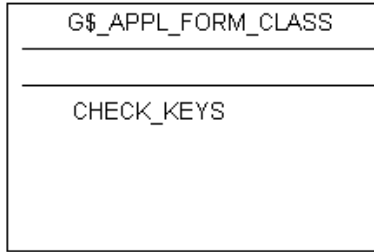

Figure 3: Subclass G\$_APPL_FORM_CLASS

Subclass G\$_INQ_FORM_CLASS

The subclass G\$_INQ_FORM_CLASS defines a form with or without a key block where the operations of creation, modification and deletion are not allowed.

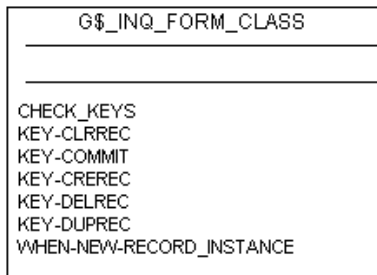

Figure 4: Subclass G\$_INQ_FORM_CLASS

Thus far, we have defined one superclass, G\$_FORM_CLASS, and three subclasses, each of which inherits from the superclass. The inheritance tree below provides a visual representation of the layers of class hierarchy, where descent from the tree implies the further specialized of behavior. Inheritance can be defined as a technique used between classes to implement classification.

Inheritance

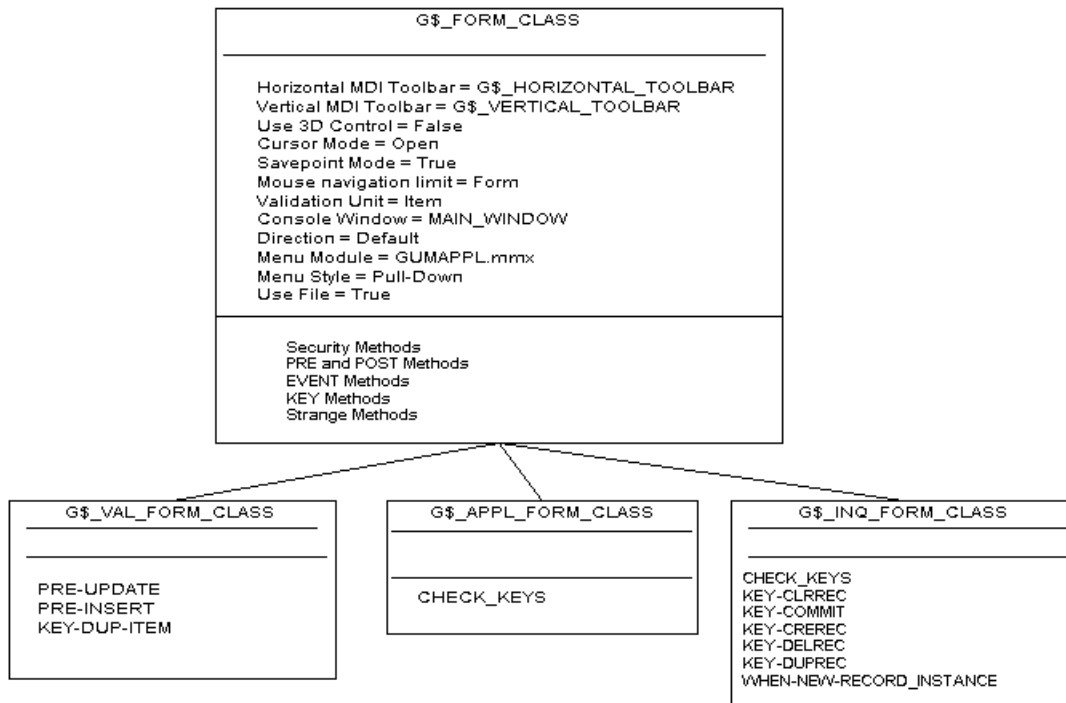

Figure 5: Inheritance of Class

Banner can be viewed as a collection of forms, each of which performs specific functions. The forms can be categorized into forms that allow or do not allow the creation, modification and deletion of rows, as well as forms that have and do not have a key block.

Menu, Application, Validation and Rule forms inherit the **G\$_APPL_FORM_CLASS** if they contain a key block. If there is no key block in these forms, they inherit the **G\$_VAL_FORM_CLASS**.

Forms that do not allow a user to create, modify, or delete rows (e.g., Inquiry, Query, Wizard, and Control forms) inherit the class **G\$_INQ_FORM_CLASS**, regardless of the existence of the key block.

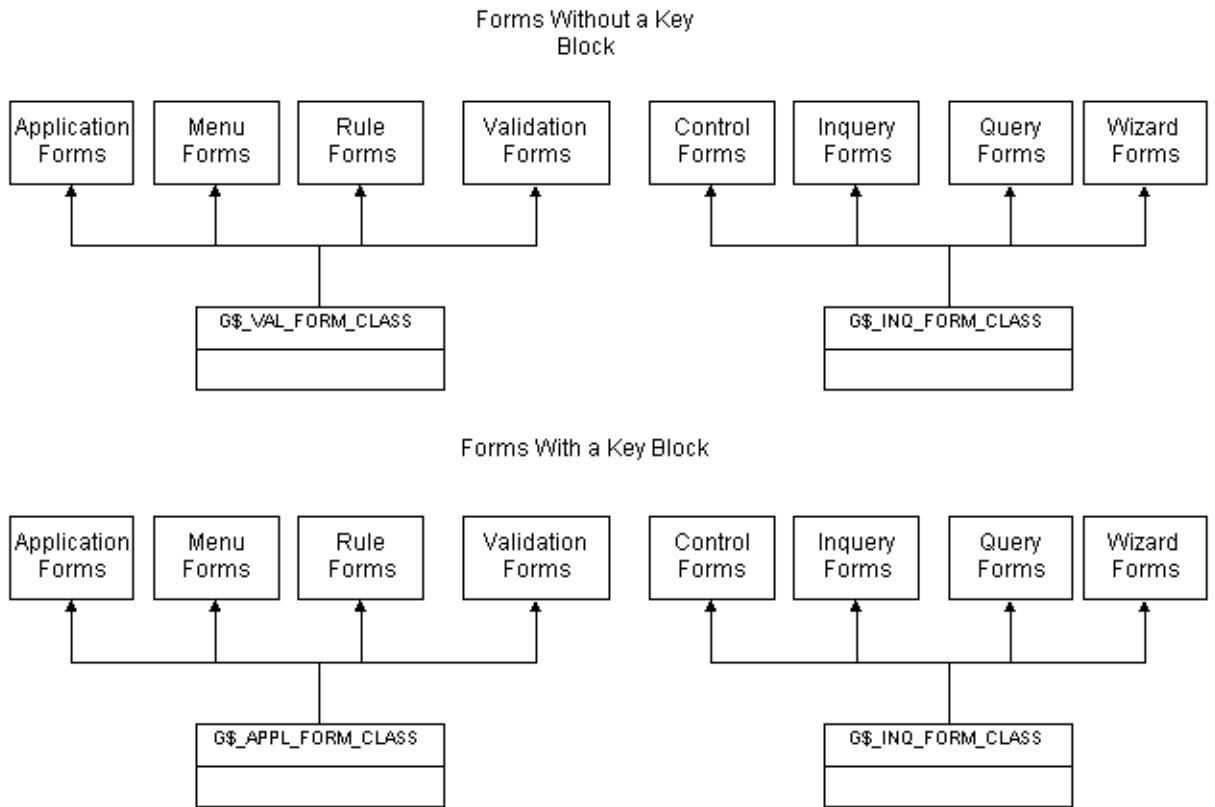

Figure 6: Class inheritance and classification of forms.

A Form as An Object

The superclass `G$_FORM_CLASS` and its subclasses define the behavior of form as a whole. The appropriate subclass therefore needs to be referenced into a form. The appropriate subclass for a form is selected using the Class attribute of the Form Module property sheet for that form. Once a form has been associated with the appropriate subclass, the form can be referred to as an object. Objects have certain characteristics such as the ability of interacting, passing, and receiving messages. In Banner, forms communicate with each other by passing parameters and global variables.

Interaction Between Two or More Forms

Every time a form calls another form, it passes three parameters: `G$_HT_TOOLBAR`, `G$_VT_TOOLBAR` and `G$_PREFERENCES`. `G$_HT_TOOLBAR` contains information about the buttons displayed on the horizontal toolbar. This information provides the position and the attributes of the buttons as defined in the General User Preferences Maintenance Form (GUAUPRF). `G$_VT_TOOLBAR` is identical to the previous parameter, but it contains information about buttons displayed in the vertical toolbar. `G$_PREFERENCES` provides information about six preferences as defined in GUAUPRF:

Display Horizontal Toolbar: attributes (Y/N)

Display Vertical Toolbar: attributes (Y/N)

These toolbars are part of the MDI Window, and they have the options to be turned on so that they are displayed.

Display Bubble Help: attribute (Y/N)

The bubble help is a hint that is displayed when the mouse goes over the button. It is available only for iconic buttons.

Display Form Name on Title Bar: attributes (Y/N)

The seven- or eight-character form name will appear after the form name and description in the title bar of the main window, and after each window name and description in the title bar of any secondary windows.

Display Release Number on Title Bar: attributes (Y/N)

The form release number shows the current version of a form and it will appear after the seven- or eight-character form name. The release number is stored in the LOAD_CURRENT_RELEASE form level trigger, for example:

```
:CURRENT_RELEASE := '6.0';
```

Display Database Instance on Title Bar: attributes (Y/N)

The database instance will appear after the window name.

Global variables are not passed like the way parameters are passed. Global variables reside in memory, and forms read and modify them as needed.

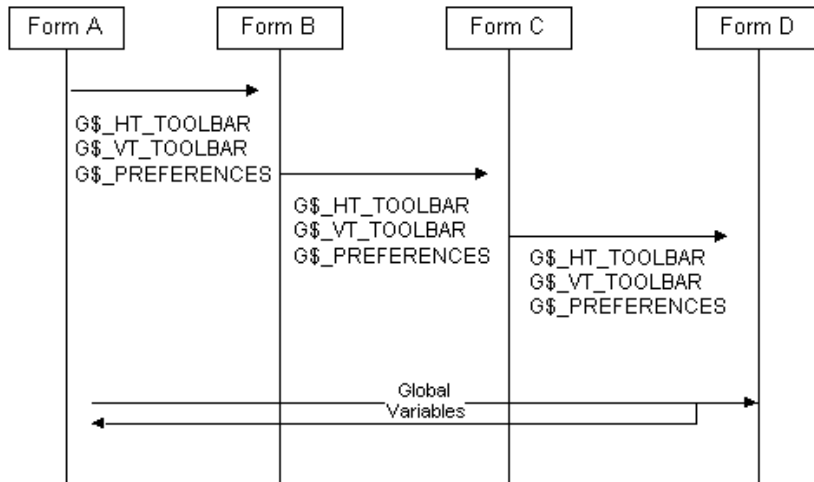

Figure 7: Representation of interaction between forms.

Key Block

A key block is a type of control block. There are two characteristics of the key block. It has one record, and the items of that record are a representation of keys, which hold the values of the items. The keys will be used to query subsequent blocks in the same form.

The attributes of G\$_KEY_BLOCK_CLASS

Records Displayed = 1
Record Orientation = Vertical
Navigation Style = Same Record
Primary Key = False
Column Security = False
Delete Allowed = True
Insert Allowed = True
Query Allowed = True
WHERE Clause = key-block

This is the signature of the block. It is used when interacting with other blocks.

Records Buffered = 1
Records Fetched = 0
Update Allowed = True
Update Changed Columns = False
Key Mode = Unique
Locking Mode = Immediate
Transactional Triggers = False
Direction = Default
In Menu = True
Block Description = Key Information Block

The Methods of G\$_KEY_BLOCK_CLASS

POST-BLOCK
KEY-COMMIT
KEY-UP
KEY-DOWN
KEY-CREREC
KEY-DELREC
KEY-ENTQRY
KEY-EXEQRY
KEY-NXTREC
KEY-NXTSET
KEY-NXTBLK

KEY-PRVBLK
KEY-PRVREC

The Class G\$_KEY_BLOCK_CLASS

The class G\$_KEY_BLOCK_CLASS is a prototype of a key block for any form. The attributes define the key block class as a non-base table block with one record only. The methods are responsible for navigation within the block and for disabling transactional functions.

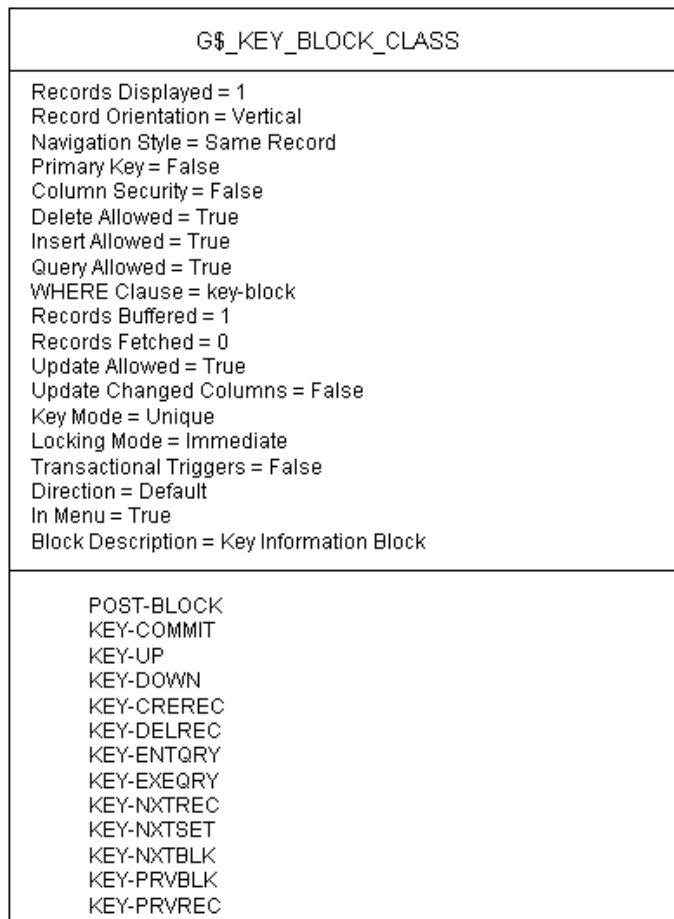

Figure 8: Key Block class

Interaction Between the Key Block and Other Blocks

The key block has the ability to exchanging messages with other blocks. The key block sends a message to validate the items in the key block. This is done by setting the parameter CHECK_KEYS to *Y*. Also, other blocks communicate with the key block, asking the key block to change the values of its keys as required. This is accomplished by setting the parameter CHECK_KEYS to *N*.

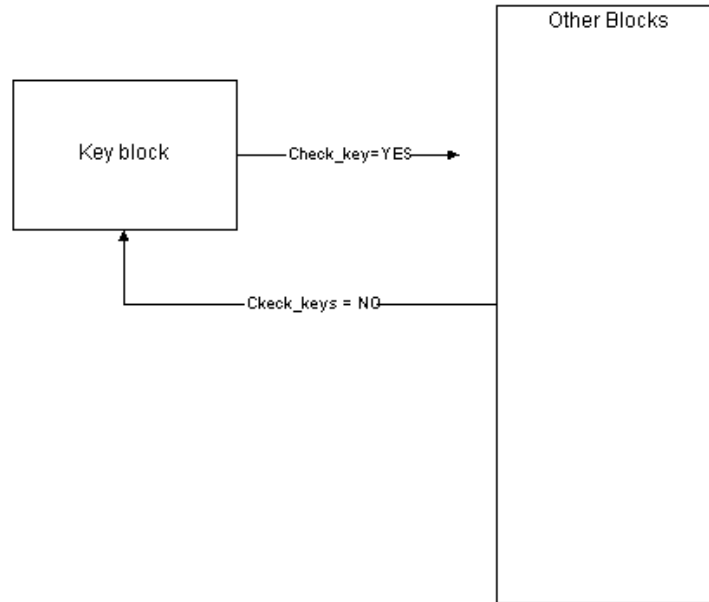

Figure 9: Example of interaction between a key block and other blocks in a form

Of the triggers, which control the functions of a key block, the trigger POST-BLOCK is generally responsible for altering the value of the variable CHECK_KEYS. Generally, CHECK_KEYS allows the disabling of the key items displayed in a key block before navigating into another block.

The function ROLLBACK allows a user to leave any block and navigate back to the key block. This operation saves the keys into global variables, then enables the keys in the key block and lastly copies the content of the global variables back to the item keys.

The G\$_FS_CANVAS_CLASS Class

The G\$_FS_CANVAS_CLASS defines one canvas-view as the main canvas, generally associated with the main window. Only the canvases that have the width and height of 473 X 328 points have the G\$_FS_CANVAS_CLASS assigned to it as a Class in the 'canvas-view' property sheet.

Attributes

Canvas-view Type = Content
 Display = TRUE
 Width = 473
 Height = 328
 Bevel = None
 Visual Attribute Name = none
 Raise on Entry = False
 X Position on Canvas = 0
 Y Position on Canvas = 0

Direction = Default
View Width = 0
View Height = 0
Display X position = 0
Display Y Position = 0
View Horizontal Scroll Bar = False
View Vertical Scroll Bar = False

The G\$_FS_WINDOW_CLASS Class

Windows that have the width and height of 473 x 328 points are assign to the G\$_FS_WINDOW_CLASS in the Class attribute of the Window property. When a window includes only one block other than the key information, a block title is not needed for the data block. Where data is grouped within a block and given a title, the data is enclosed by a beveled box. The title for that block is then centered on top inside the block.

Attributes

X position = 0
Y Position = 0
Width = 473
Height = 328
Bevel = Raised
Visual Attribute Name = none
Window Style = Document
Modal = false
Remove on exit = false
Direction = Default
Horizontal Scroll Bar = False
Vertical scroll Bar = False
Closeable = False
Fixed Size = False
Iconifiable = True
Inherit Menu = True
Moveable = True
Zoomable = False

Items

There are three types of items that are identified by classes: items that enable search on any code and description, items that enable search on ID and Name only, and items having the data type Date.

The G\$_CODE_CLASS Class

The class G\$_CODE_CLASS models a search mechanism on any code and any description within the appropriate associated tables.

The code item, through the method `KEY-NEXT-ITEM` performs a request to the database to search for a particular code or description. If a code or description that matches the value entered by a user does not exist, the code item sends back a not found message. If either a matching code or description exists, a list of matches is presented to the user.

Attributes

Item Type = Text Item
Displayed = True
Bevel = Lowered
Rendered = True
Visual Attribute name =
Current Record Attribute =
Maximum Length =
Enabled = True
Navigable = True
Query Only = False
Insert Allowed = True
Query Allowed = True
Query Length = 0
Case Insensitive Query = False
Update Allowed = True
Update Only if Null = False
Lock Record = False
Case Restriction = Upper
Alignment = Left
Multi-line = False
Wrap Style = None
Secure = False
Keep Position = False
= True
Reading Order = Default
Initial Keyboard State = Default
Vertical Scroll bar = False
Auto hint = true

Methods

WHEN-MOUSE-DOUBLECLICK
WHEN-NEW-ITEM-INSTANCE
G\$_SEARCH_PARAMETERS
G\$_SEARCH_OPTION
KEY-NEXT-ITEM
POST-TEXT-ITEM

The G\$_DESC_CLASS Class

This class displays the description of code and description.

Attributes

Item type = text item
Displayed = True
Bevel = Lowered
Rendered = True
Maximum Length = 30
Enabled = True
Navigable = False
Base Table Item = False
Query Only = False
Primary key = False
Insert Allowed = True
Query Allowed = False
Case Insensitive Query = False
Update Allowed = False
Update Only if Null = False
Lock Record = False
LOV for Validation = False
Hint = G\$_DESC_ITEM

Methods

WHEN-NEW-ITEM-INSTANCE

The Class G\$_ID_CLASS

The class G\$_ID_CLASS models a search mechanism on any ID and any Name within the appropriate associated tables.

The ID item, through the method KEY-NEXT-ITEM performs a request to the database to search for a particular ID or Name. If an ID or Name that matches the value entered by a user does not exist, the code item sends back a not found message. If either a matching ID or Name exists, a list of matches is presented to the user.

Attributes

Item Type = Text Item
Displayed = True
Width = 54
Height = 17
Bevel = Lowered
Rendered = True
Visual Attribute name = G\$_NVA_TEXT_ITEM

Current Record Attribute =
Data type = CHAR
Maximum Length = 9
Fixed Length = False
Required = False
Format Mask =
Range Low Value =
Range High Value =
DefaultValue =
Copy Value From Item =
Enabled = True
Navigable = True
Query only = False
Primary key = False
Insert Allow = true
Query Length = 9
Case Insensitive Query = False
Lock Record = False
Case Restriction = Upper
Alignment = Left
Multi-line = False
Wrap Style =None
Secure = False
Keep Position = False
Auto Skip = true
Reading Order = Default
Initial Keyboard state = Default
Vertical Scroll Bar = False
Auto Hint = True

Methods

PRE-TEXT-ITEM
KEY-NEXT-ITEM
KEY-LISTVAL
KEY-CQUERY
WHEN-VALIDATE-ITEM
POST-CHANGE

The Class G\$_NAME_CLASS

This class displays the Name of an associated ID.

Attributes

Item Type = Text Item
Displayed = True
Height = 17
Bevel = Lowered

Rendered = True
Visual Attribute name = G\$_NVA_TEXT_ITEM
Current Record Attribute =
Data type = CHAR
Maximum Length = 99
Fixed Length = False
Required = False
Item Displayed = 0
Enabled = True
Navigable = False
Base Table Item = False
Query only = False
Primary key = False
Insert Allow = true
Query Allow = False
Update Allowed = True
Update only if Null = False
Case Insensitive Query = False
Lock Record = False
Case Restriction = Mixed
Alignment = Left
Multi-line = False
Wrap Style =None
Secure = False
Keep Position = False
Auto Skip = False
Reading Order = Default
Initial Keyboard state = Default
Vertical Scroll Bar = False
Hint = Name; Enter a name Last, First, Middle and press enter or tab. Use the wildcard '%' if needed.
Auto Hint = True

Methods

KEY-NEXT-ITEM

The Class G\$_FF_NAME_CLASS

This class displays the Name of an associated ID and allows the user to change its value and save it the database. This class has the same attributes and methods of G\$_NAME_CLASS.

The G\$_DATE_CLASS Class

This class is a super class that models the treatment of date items in a form.

Attributes

Item Type = Text Item
Height = 17
Bevel = Lowered
Rendered = True
Visual Attribute Name = G\$_NVA_TEXT_ITEM
Current Record Attribute =
Data Type = Date
Maximum Length = 11
Fixed Length = True
Format Mask = DD-MON-RRRR
Item Displayed = 0
Query Length = 14
Case Insensitive Query = False
Case Restriction = Upper
Alignment = Left
Multi-Line = False
Wrap Style = None
Secure = False
Keep Position = False
Reading Order = Default
Initial Keyboard State = Default
Vertical Scroll Bar = False

Methods

KEY-NEXT-ITEM
WHEN-NEW-ITEM-INSTANCE
POST-TEXT-ITEM

The G\$_DATETIME_CLASS Class

G\$_DATETIME_CLASS is a subclass that inherits attributes and methods of G\$_DATE_CLASS, where date and time is a specialization of date.

Attributes

Class = G\$_DATE_CLASS
Data Type = Date
Maximum Length = 26
Query Length = 30

The G\$_ICON_BTN_CLASS Class

G\$_ICON_BTN_CLASS is a class used to create iconic buttons.

Attributes

Item Type = Button
Displayed = True
Width = 17
Height = 17
Visual Attribute Name = G\$_NVA_BUTTON_ITEM
White on Black = False
Item Displayed = 0
Enabled = True
Navigable = False
Mouse Navigable = False
Access Key =
Direction = Default
Iconic = True
Default Button = False
Auto Hint = False

Methods

WHEN-MOUSE-CLICK
WHEN-MOUSE-ENTER
WHEN-MOUSE-LEAVE

The G\$_FLASHLITE_BTN_CLASS Class

This is a further specialization of G\$_ICON_BTN_CLASS, which specifies “Flashlight” iconic buttons. This class is a subclass of G\$_ICON_BTN_CLASS.

Attributes

Icon Name = flashlit

Implementation View

This section describes a significant portion of Banner code.

GOQOLIB

GOQOLIB is a form that is used as a repository to store triggers, blocks, windows, canvases, visual attributes, items, and classes that can be referenced. All the triggers of GOQOLIB are embedded into classes. Many of these triggers in turn execute procedures

and functions that are stored in the GOQRPLS library. Changes made to the GOQOLIB will be reflected in all forms that reference it whenever they are regenerated.

Fundamental Methods of G\$_FORM_CLASS

Fundamental Methods are triggers that must be used in any form. At runtime, form trigger can change behavior by executing another trigger that has the same name and has as the last four letters *_TRG*. This is a mechanism that changes pre-defined behavior of triggers. This mechanism is available only in some triggers as specified below.

Pre-Form Trigger

The code of Pre-form trigger is member of the package G\$_GOQOLIB_PP_TRIGGER and is named as G\$_GOQOLIB_PP_TRIGGER.PRE_FORM. This trigger is responsible for checking whether a user is authorized to run a form.

```
PROCEDURE PRE_FORM
BEGIN
EXECUTE_TRIGGER('LOAD_CURRENT_RELEASE');
G$_CHECK_FAILURE;
EXECUTE_TRIGGER('G$_VERIFY_ACCESS');
G$_CHECK_FAILURE;
DEFAULT_VALUE( '0', 'global.query_mode' );
G$_FORM_STARTUP;
G$_CHECK_FAILURE;
EXECUTE_TRIGGER('PRE_FORM_TRG');
G$_CHECK_FAILURE;
END;
```

To add custom code to the form create a user-defined trigger with the name
PRE_FORM_TRG.

Post-Form Trigger

The code of the trigger POST-FORM is stored in the G\$_GOQOLIB_PP_TRIGGER and has the name of G\$_GOQOLIB_PP_TRIGGER.POST_FORM. This trigger is responsible for executing the shutdown procedures of a form.

```
PROCEDURE POST_FORM IS
BEGIN
EXECUTE_TRIGGER('SAVE_KEYS');
G$_CHECK_FAILURE;
EXECUTE_TRIGGER('POST_FORM_TRG');
G$_CHECK_FAILURE;
G$_FORM_SHUTDOWN;
G$_CHECK_FAILURE;
EXECUTE_TRIGGER('G$_REVOKE_ACCESS');
END;
```

To add custom code to the form creates a user defined trigger with the name
POST_FORM_TRG.

Pre-Block Trigger

The code in the trigger PRE-BLOCK is stored as G\$_GOQOLIB_PP_TRIGGER.PRE_BLOCK. This trigger is responsible for populating the navigation frame and highlighting the focused block.

```
PROCEDURE PRE_BLOCK IS
Curr_Block_Name VARCHAR2(60):=NAME_IN('SYSTEM.TRIGGER_BLOCK');
Curr_Item_Name VARCHAR2(60) :=
GET_BLOCK_PROPERTY(Curr_Block_Name,FIRST_ITEM);
Visual_Attribute_Name VARCHAR2(60) := 'G$_NVA_ITEM_REQUIRED';
rg_optm CONSTANT VARCHAR2(13):= 'G$_GUROPTM_RG';
rg_id RECORDGROUP := FIND_GROUP(rg_optm);
BEGIN
--
IF NAME_IN('SYSTEM.MODE') = 'ENTER-QUERY' THEN
G$_NAVIGATION_FRAME.POPULATE_GUROPTM;
ELSE
IF NOT ID_NULL(rg_id) THEN
IF NVL(GET_GROUP_SELECTION_COUNT(rg_id),0) > 0 AND
NAME_IN('G$_NAVIGATION_BLOCK.GUROPTMDSPITM_1')
IS NULL THEN
G$_NAVIGATION_FRAME.POPULATE_GUROPTM;
END IF;
ELSE
G$_NAVIGATION_FRAME.POPULATE_GUROPTM; -- covering Normal
END IF;
END IF;
--
WHILE (Curr_Item_Name IS NOT NULL) LOOP
Curr_Item_Name := Curr_Block_Name||'.'||Curr_Item_Name;
IF (GET_ITEM_PROPERTY(Curr_Item_Name,ITEM_TYPE) = 'TEXT
ITEM' OR GET_ITEM_PROPERTY(Curr_Item_Name,ITEM_TYPE) =
'LIST') AND GET_ITEM_PROPERTY(Curr_Item_Name,ITEM_CANVAS)IS
NOT NULL THEN
SET_ITEM_PROPERTY(Curr_Item_Name,CURRENT_RECORD_ATTRIBUTE,
Visual_Attribute_Name);
IF GET_BLOCK_PROPERTY(Curr_Block_Name,RECORDS_DISPLAYED)> 1 THEN
IF GET_ITEM_PROPERTY(Curr_Item_Name,BORDER_BEVEL) = 'NONE' THEN
SET_ITEM_PROPERTY(Curr_Item_Name,CURRENT_RECORD_ATTRIBUTE,
'DEFAULT');
ELSE
SET_ITEM_PROPERTY(Curr_Item_Name,CURRENT_RECORD_ATTRIBUTE,
'G$_NVA_HIGHLITE_TEXT');
END IF;
END IF;
END IF;
Curr_Item_Name :=GET_ITEM_PROPERTY(Curr_Item_Name,NEXTITEM);
END LOOP;
--
EXECUTE_TRIGGER('PRE_BLOCK_TRG');
G$_CHECK_FAILURE;
END;
```

To add custom code to the form creates a user defined trigger with the name PRE_BLOCK_TRG.

If a PRE-BLOCK trigger needs to be placed at a block level, this trigger will function in conjunction with the trigger PRE-BLOCK at the form level, which is part of the method of G\$_FORM_CLASS. Create the PRE-BLOCK trigger at the block level, in the property sheet of the trigger, set the CLASS property to G\$_AFTER_TRG_CLASS.

Post-Block Trigger

The code of the trigger POST-BLOCK is stored in G\$_GOQOLIB_PP_TRIGGER.POST_BLOCK. This trigger is responsible for the restoration of the visual attribute in a block, altered by the PRE-BLOCK trigger.

```
PROCEDURE POST_BLOCK IS
Curr_Block_Name VARCHAR2(60):=NAME_IN('SYSTEM.TRIGGER_BLOCK');
Curr_Item_Name VARCHAR2(60):=
GET_BLOCK_PROPERTY(Curr_Block_Name,FIRST_ITEM);
Visual_Attribute_Name VARCHAR2(60) := 'G$_NVA_ITEM_REQUIRED';
BEGIN
G$_TRACE_PKG.TRACE_RTN('G$_GOQOLIB_PP_TRIGGER.POST_BLOCK BEGIN');
--
WHILE (Curr_Item_Name IS NOT NULL) LOOP
Curr_Item_Name := Curr_Block_Name || '.' || Curr_Item_Name;
IF (GET_ITEM_PROPERTY(Curr_Item_Name,ITEM_TYPE) = 'TEXT ITEM' OR
GET_ITEM_PROPERTY(Curr_Item_Name,ITEM_TYPE) = 'LIST')
AND GET_ITEM_PROPERTY(Curr_Item_Name,ITEM_CANVAS) IS NOT
NULL THEN
IF GET_BLOCK_PROPERTY(Curr_Block_Name,RECORDS_DISPLAYED)
> 1 THEN
IF GET_ITEM_PROPERTY(Curr_Item_Name,BORDER_BEVEL) =
'NONE' THEN
SET_ITEM_PROPERTY(Curr_Item_Name,
CURRENT_RECORD_ATTRIBUTE,'DEFAULT');
ELSE
SET_ITEM_PROPERTY(Curr_Item_Name,
CURRENT_RECORD_ATTRIBUTE,'G$_NVA_TEXT_ITEM');
END IF;
END IF;
END IF;
Curr_Item_Name :=
GET_ITEM_PROPERTY(Curr_Item_Name,NEXTITEM);
END LOOP;
--
EXECUTE_TRIGGER('POST_BLOCK_TRG'); G$_CHECK_FAILURE;
END;
--
```

To add custom code to the form creates a user defined trigger with the name POST_BLOCK_TRG.

If a POST-BLOCK trigger needs to be placed at a block level, this trigger will function in conjunction with the trigger POST-BLOCK at the form level, which is part of the method of

G\$_FORM_CLASS. Create the POST-BLOCK trigger at the block level, in the property sheet of the trigger, set the CLASS property to G\$_AFTER_TRG_CLASS.

When-New-Block-Instance Trigger

The trigger code of WHEN-NEW-BLOCK-INSTANCE is located in the trigger itself. It should always be coupled with the user-define trigger WHEN_NEW_BLOCK_TRIGGER_INSTANCE_TRG. This trigger is also responsible for the correct population of the navigation frame.

```
BEGIN
G$_NAVIGATION_FRAME.POPULATE_GUROPTM;
G$_CHECK_FAILURE;
--
IF G$_NAVIGATION_FRAME.MESSAGE_WAS_DISPLAYED = 'N'
THEN
G$_DO_NEW_MESSAGES_EXIST;
G$_NAVIGATION_FRAME.MESSAGE_WAS_DISPLAYED := 'Y';
END IF;
--
EXECUTE_TRIGGER('WHEN_NEW_BLOCK_INSTANCE_TRG');
G$_CHECK_FAILURE;
END;
```

If a WHEN-NEW-BLOCK-INSTANCE trigger needs to be placed at a block level, this trigger will function in conjunction with the trigger WHEN-NEW-BLOCK-INSTANCE at the form level, which is part of the method of G\$_FORM_CLASS. Create the WHEN-NEW-BLOCK-INSTANCE trigger at the block level, in the property sheet of the trigger, set the CLASS property to G\$_AFTER_TRG_CLASS.

LOAD_FORM_HEADER Trigger

Form header information is populated by G\$_LOAD_FORM_HEADER. This trigger is responsible for the population of a standard form header block as defined in previous releases. No mechanism is provided to change pre-defined behavior of this trigger.

```
PROCEDURE G$_LOAD_FORM_HEADER IS
-- populates form heading items
itm_id ITEM := FIND_ITEM('CURRENT_USER');
BEGIN
COPY(TO_CHAR(SYSDATE,'DD-MON-YYYY'),'CURRENT_DATE');
COPY(TO_CHAR(SYSDATE,'HH24:MI:SS'),'CURRENT_TIME');
COPY(NAME_IN('SYSTEM.CURRENT_FORM'),'CURRENT_FORM');
COPY(NAME_IN('GLOBAL.INSTITUTION'),'CURRENT_INSTITUTION');
--
IF NOT ID_NULL(itm_id) THEN
COPY(NAME_IN('GLOBAL.USER_ID'),'CURRENT_USER');
END IF;
--
EXECUTE_TRIGGER('LOAD_CURRENT_RELEASE');
G$_CHECK_FAILURE;
END;
```

When-New-Record-Instance Trigger

This trigger is responsible for the navigation between records of the same block and is located in the following package:

```
G$_GOQOLIB_USER_TRIGGER.WHEN_NEW_REC_INST
```

```
PROCEDURE WHEN_NEW_REC_INST IS
BEGIN
IF NAME_IN('SYSTEM.RECORD_STATUS') = 'NEW' THEN
IF NAME_IN('SYSTEM.CURSOR_RECORD') <> '1' THEN
PREVIOUS_RECORD;
MESSAGE('At Last Record', NO_ACKNOWLEDGE);
END IF;
END IF;
END;
```

KEY-CLRFRM Trigger

The code of the trigger KEY-CLRFRM is located in the package G\$_GOQOLIB_KEY_TRIGGER and is named G\$_GOQOLIB_KEY_TRIGGER.KEY_CLRFRM. This trigger is responsible for the correct execution of the function ROLLBACK.

```
PROCEDURE KEY_CLRFRM IS
BEGIN
EXECUTE_TRIGGER('SAVE_KEYS');
G$_CHECK_FAILURE;
EXECUTE_TRIGGER('ENABLE_KEYS');
G$_CHECK_FAILURE;
--
CLEAR_FORM;
IF NAME_IN('SYSTEM.FORM_STATUS') <> 'CHANGED' THEN
G$_LOAD_FORM_HEADER;
G$_CHECK_FAILURE;
EXECUTE_TRIGGER('GLOBAL_COPY');
G$_CHECK_FAILURE;
IF GET_BLOCK_PROPERTY(NAME_IN('SYSTEM.CURRENT_BLOCK'),
BASE_TABLE) IS NOT NULL THEN
EXECUTE_QUERY;
G$_CHECK_FAILURE;
END IF;
END IF;
G$_TRACE_PKG.TRACE_RTN('G$_GOQOLIB_KEY_TRIGGER.KEY_CLRFRM END');
END;
```

KEY-NXTBLK

The code of the trigger KEY-NXTBLK is located in the package G\$_GOQOLIB_KEY_TRIGGER and is named G\$_GOQOLIB_KEY_TRIGGER.KEY_NXTBLK. This trigger is responsible for forward navigation of blocks associated with the key function next block.

```

PROCEDURE KEY_NXTBLK IS
nxtblk   VARCHAR2(80) :=
GET_BLOCK_PROPERTY(NAME_IN('SYSTEM.TRIGGER_BLOCK'),NEXT_
NAVIGATION_BLOCK);
blkstatus VARCHAR2(20) := NULL;
BEGIN
IF SUBSTR(nxtblk,1,2) = 'G$' THEN
WHILE SUBSTR(nxtblk,1,2) = 'G$' LOOP
nxtblk :=
GET_BLOCK_PROPERTY(nxtblk,NEXT_NAVIGATION_BLOCK);
END LOOP;
END IF;
--
IF nxtblk = NAME_IN('SYSTEM.TRIGGER_BLOCK') THEN
G$_INVALID_FUNCTION_MSG;
ELSE
GO_BLOCK(nxtblk);
blkstatus := GET_BLOCK_PROPERTY(nxtblk,STATUS);
IF blkstatus = 'NEW' AND
GET_BLOCK_PROPERTY(nxtblk,BASE_TABLE) IS NOT NULL THEN
EXECUTE_QUERY;
END IF;
END IF;
END;

```

KEY-PREVBLK

The code of the trigger KEY-PREVBLK is located in the package G\$_GOOOLIB_KEY_TRIGGER and is named G\$_GOOOLIB_KEY_TRIGGER.KEY-PREVBLK. This trigger is responsible for the backward navigation between blocks, associated with the key previous block.

```

PROCEDURE KEY_PRVBLK IS
prevblk  VARCHAR2(80) :=
GET_BLOCK_PROPERTY(NAME_IN('SYSTEM.TRIGGER_BLOCK'),
PREVIOUS_NAVIGATION_BLOCK);
blkstatus VARCHAR2(20) := NULL;
BEGIN
IF GET_BLOCK_PROPERTY(prevblk,DEFAULT_WHERE) = 'key-block' THEN
prevblk :=
GET_BLOCK_PROPERTY(prevblk,PREVIOUS_NAVIGATION_BLOCK);
IF SUBSTR(prevblk,1,2) = 'G$' THEN
WHILE SUBSTR(prevblk,1,2) = 'G$' LOOP
prevblk :=
GET_BLOCK_PROPERTY(prevblk,
PREVIOUS_NAVIGATION_BLOCK);
END LOOP;
END IF;
ELSIF SUBSTR(prevblk,1,2) = 'G$' THEN
WHILE SUBSTR(prevblk,1,2) = 'G$' LOOP
prevblk :=
GET_BLOCK_PROPERTY(prevblk,PREVIOUS_NAVIGATION_BLOCK);
END LOOP;
END IF;
--
IF prevblk = NAME_IN('SYSTEM.TRIGGER_BLOCK') THEN

```

```

G$_INVALID_FUNCTION_MSG;
ELSE
GO_BLOCK(prevblk);
blkstatus := GET_BLOCK_PROPERTY(prevblk,STATUS);
IF blkstatus = 'NEW' AND
GET_BLOCK_PROPERTY(prevblk,BASE_TABLE) IS NOT NULL THEN
EXECUTE_QUERY;
END IF;
END IF;
END;

```

KEY-EXIT

The code of the trigger KEY-EXIT is located in the package G\$_GOQOLIB_KEY_TRIGGER and is named G\$_GOQOLIB_KEY_TRIGGER.KEY_EXIT. This trigger is responsible for the correct exiting from a form.

```

PROCEDURE KEY_EXIT IS
BEGIN
EXECUTE_TRIGGER('KEY_EXIT_TRG');
G$_CHECK_FAILURE;
COPY('','GLOBAL.VALUE');
B2K_EXIT_FORM;
G$_CHECK_FAILURE;
END;

```

B2K_EXIT_FORM

Even when the user defines her own KEY-EXIT trigger it is strongly recommended to add the trigger B2K_EXIT_FORM to substitute the defective Oracle Forms KEY function KEY_EXIT.

This trigger is located in the package G\$_GOQOLIB_KEY_TRIGGER and is named G\$_GOQOLIB_KEY_TRIGGER.B2K_EXIT_FORM.

```

PROCEDURE B2K_EXIT_FORM IS
ALERT_BUTTON NUMBER;
CUR_ITEM      VARCHAR2(61) := NAME_IN('SYSTEM.CURSOR_ITEM');
BEGIN
G$_TRACE_PKG.TRACE_RTN('G$_GOQOLIB_KEY_TRIGGER.B2K_EXIT_FORM');
--
-- If in enter-query mode
--
IF NAME_IN('SYSTEM.MODE') = 'ENTER-QUERY' THEN EXIT_FORM;
RETURN;
END IF;
--
-- reset the form validation
--
IF GET_FORM_PROPERTY(NAME_IN('SYSTEM.CURRENT_FORM'), VALIDATION)
= 'FALSE' THEN
SET_FORM_PROPERTY(NAME_IN('SYSTEM.CURRENT_FORM'), VALIDATION,
PROPERTY_ON);

```

```

END IF;
--
-- This is to force item level validation
--
--     COPY('25','SYSTEM.MESSAGE_LEVEL');
VALIDATE(BLOCK_SCOPE);
--
-- If validation fails, ask to close form
--
IF NOT FORM_SUCCESS THEN
COPY('0','SYSTEM.MESSAGE_LEVEL');
--
alert_button := SHOW_ALERT('G$_CLOSE_FORM_ALERT');
IF alert_button = ALERT_BUTTON1 THEN
CLEAR_MESSAGE;
SET_FORM_PROPERTY(NAME_IN('SYSTEM.CURRENT_FORM'),
DEFER_REQUIRED_ENFORCEMENT,PROPERTY_TRUE);
SET_FORM_PROPERTY(NAME_IN('SYSTEM.CURRENT_FORM'),
VALIDATION_UNIT,FORM_SCOPE);
SET_FORM_PROPERTY(NAME_IN('SYSTEM.CURRENT_FORM'),
VALIDATION,PROPERTY_FALSE);
EXIT_FORM(NO_VALIDATE,FULL_ROLLBACK);
ELSE
RETURN;
END IF;
END IF;
--
PREVIOUS_ITEM;
COPY('0','SYSTEM.MESSAGE_LEVEL');
--
-- If no changes, just exit
--
IF NAME_IN('SYSTEM.FORM_STATUS') = 'QUERY' THEN
SET_FORM_PROPERTY(NAME_IN('SYSTEM.CURRENT_FORM'),
DEFER_REQUIRED_ENFORCEMENT,PROPERTY_TRUE);
SET_FORM_PROPERTY(NAME_IN('SYSTEM.CURRENT_FORM'),
VALIDATION_UNIT,FORM_SCOPE);
SET_FORM_PROPERTY(NAME_IN('SYSTEM.CURRENT_FORM'),
VALIDATION,PROPERTY_FALSE);
EXIT_FORM(NO_VALIDATE);
--
-- Ask to save or not
--
ELSE
alert_button := SHOW_ALERT('G$_EXIT_FORM_ALERT');
--
-- Exit saving changes
--
IF alert_button = ALERT_BUTTON1 THEN
COMMIT_FORM;
--
-- Commit failed, ask to close form
--
IF NOT FORM_SUCCESS OR NAME_IN('SYSTEM.FORM_STATUS') <>
'QUERY' THEN
alert_button := SHOW_ALERT('G$_CLOSE_FORM_ALERT');
IF alert_button = ALERT_BUTTON1 THEN

```

```

CLEAR_MESSAGE;
SET_FORM_PROPERTY(NAME_IN('SYSTEM.CURRENT_FORM'),
DEFER_REQUIRED_ENFORCEMENT,PROPERTY_TRUE);
SET_FORM_PROPERTY(NAME_IN('SYSTEM.CURRENT_FORM'),
VALIDATION_UNIT,FORM_SCOPE);
SET_FORM_PROPERTY(NAME_IN('SYSTEM.CURRENT_FORM'),
VALIDATION,PROPERTY_FALSE);
EXIT_FORM(NO_VALIDATE,FULL_ROLLBACK);
ELSE
GO_ITEM(CUR_ITEM);
RETURN;
END IF;
--
-- Commit worked, exit
--
ELSE
EXIT_FORM;
END IF;
--
-- Exit without saving changes.
--
ELSIF alert_button = ALERT_BUTTON2 THEN
SET_FORM_PROPERTY(NAME_IN('SYSTEM.CURRENT_FORM'),
DEFER_REQUIRED_ENFORCEMENT,PROPERTY_TRUE);
SET_FORM_PROPERTY(NAME_IN('SYSTEM.CURRENT_FORM'),
VALIDATION_UNIT,FORM_SCOPE);
SET_FORM_PROPERTY(NAME_IN('SYSTEM.CURRENT_FORM'),
VALIDATION,PROPERTY_FALSE);
EXIT_FORM(NO_VALIDATE,FULL_ROLLBACK);
--
-- Don't exit.
--
ELSE
GO_ITEM(CUR_ITEM);
RETURN;
END IF;
END IF;
END;

```

KEY-NXTKEY

Forms that are called by other forms and that have the Select function in the menu bar enabled. They use the trigger KEY-NXTKEY to return values to the calling form by the event MOUSE-DOUBLE-CLICK or by selecting *Select* on the menu bar.

The trigger code of KEY-NXTKEY is located in the package G\$_GOQOLIB_KEY_TRIGGER. To add user-define code, it should be coupled with the user-defined trigger, KEY_NXTKEY_TRG.

```

PROCEDURE KEY_NXTKEY IS
curr_item VARCHAR2(61):= NAME_IN('SYSTEM.CURSOR_ITEM');
sub_len   NUMBER(10) := INSTR(curr_item,'_');
item_name VARCHAR2(60) := SUBSTR(curr_item,1,sub_len)||'CODE';
BEGIN
IF GET_MENU_ITEM_PROPERTY('Action.Select',ENABLED) = 'TRUE' THEN
IF NOT ID_NULL(FIND_ITEM(item_name)) THEN

```

```

COPY(NAME_IN(SUBSTR(curr_item,1,sub_len)||'CODE'),
'GLOBAL.VALUE');
END IF;
--
EXECUTE_TRIGGER('KEY_NXTKEY_TRG');
G$_CHECK_FAILURE;
B2K_EXIT_FORM;
END IF;
END;

```

Key Blocks

If there is a key block in the form, the G\$_KEY_BLOCK_CLASS is assigned to it in the property sheet. The class G\$_KEY_BLOCK_CLASS is a prototype of any key block in a form. The properties of the key block define the key block as a non-base table block with one record only. The triggers of the key block are responsible for the navigation within the block and the disabling of transactional functions.

```

POST-BLOCK
COPY('Y','CHECK_KEYS');

```

Case View

The case view is intended to provide a guide for the creation of new forms that comply with the Banner architecture. It is recommended that any new form be cloned from the existing skeleton forms that have also been updated to comply with this release architecture. The skeleton forms are templates that are derived from the identified families of forms.

Non-Inquiry Forms Without a Key Block

GTVSKEL.fmb provides the template for non-inquiry forms without a key block. In the Form Property sheet, the CLASS is set to G\$_VAL_FORM_CLASS.

The main window has G\$_FS_WINDOW_CLASS class applied to its property class. If the form is called by another form and its appearance is like a modal window, in the property sheet of the main window, the properties MODAL and REMOVE ON EXIT need to be set to true. In addition, in the Form Property sheet the HORIZONTAL MDI toolbar and VERTICAL MDI toolbar to need to be set to null. The main canvas has G\$_FS_WINDOW_CLASS defined as the Class in its property sheet.

The following are objects that are always referenced from the form GOQOLIB into the Object Group node of the form:

```

G$_TOOLBAR
G$_VAL_FORM_CLASS

```

If the form invokes an Option List Window, then the object `G$_OPT_GROUP` is referenced in the Object Group from `GOQOLIB`. If the form invokes Function Base information, then the object `G$_FUNC_BASE_INFO` is referenced in the Object Group from `GOQOLIB`.

If the form has ID and Name items on which a validation procedure is desired, then the object `G$_IDNAME_SEARCH` is referenced in the Object Group from `GOQOLIB`.

If the form has Code and Description items on which a search mechanism is desired, then the object `G$_SEARCH` is referenced in the Object Group from `GOQOLIB`.

Non-Inquiry Form with a Key Block

`GUASKEL.fmb` gives the template for non-inquiry forms with a key block. In the Form Property sheet, the `CLASS` is set to `G$_APPL_FORM_CLASS`.

In the Block Property sheet of the key block, the `CLASS` `G$_KEY_BLOCK_CLASS` is set in the property sheet.

The main window has `G$_FS_WINDOW_CLASS` class applied to its property class. If the form is called by another form and its appearance is like a modal window, in the property sheet of the main window, the properties `MODAL` and `REMOVE ON EXIT` need to be set to true. In addition, in the Form Property sheet the `HORIZONTAL MDI toolbar` and `VERTICAL MDI toolbar` need to be set to null. The main canvas has `G$_FS_WINDOW_CLASS` defined as the Class in its property sheet.

The following are objects that are always referenced from the form `GOQOLIB` into the Object Group node of the form:

```
G$_TOOLBAR  
G$_VAL_FORM_CLASS
```

If the form invokes an Option List Window, then the object `G$_OPT_GROUP` is referenced in the Object Group from `GOQOLIB`. If the form invokes Function Base information, then the object `G$_FUNC_BASE_INFO` is referenced in the Object Group from `GOQOLIB`.

If the form has ID and Name items on which a validation procedure is desired, then the object `G$_IDNAME_SEARCH` is referenced in the Object Group from `GOQOLIB`.

If the form has Code and Description items on which a search mechanism is desired, then the object `G$_SEARCH` is referenced in the Object Group from `GOQOLIB`.

Inquiry Forms With and Without a Key Block

`GUISKEL.fmb` gives the template for inquiry forms with and without a key block. Its major characteristics are the same as the above with the following constraints: in the Form Property sheet, the `CLASS` is set to `G$_INQ_FORM_CLASS`.

If the form has a key block then the Block Property sheet of the key block is set to the CLASS G\$_KEY_BLOCK_CLASS class.

The main window has G\$_FS_WINDOW_CLASS class applied to its property class. If the form is called by another form and its appearance is like a modal window, in the property sheet of the main window, the properties MODAL and REMOVE ON EXIT need to be set to true. In addition, in the Form Property sheet the HORIZONTAL MDI toolbar and VERTICAL MDI toolbar need to be set to null. The main canvas has G\$_FS_WINDOW_CLASS defined as the Class in its property sheet.

The following are objects that are always referenced from the form GOQOLIB into the Object Group node of the form:

G\$_TOOLBAR
G\$_VAL_FORM_CLASS

If the form invokes an Option List Window, then the object G\$_OPT_GROUP is referenced in the Object Group from GOQOLIB. If the form invokes Function Base information, then the object G\$_FUNC_BASE_INFO is referenced in the Object Group from GOQOLIB.

If the form has ID and Name items on which a validation procedure is desired, then the object G\$_IDNAME_SEARCH is referenced in the Object Group from GOQOLIB.

If the form has Code and Description items on which a search mechanism is desired, then the object G\$_SEARCH is referenced in the Object Group from GOQOLIB.

Items

ID and Name Items

To enable the search mechanism to the ID and Name items to validate IDs and names against the SPRIDEN table, the items undertake the following steps:

- 8.1.** In the property sheet of the ID item, set the CLASS to G\$_ID_CLASS.
- 8.2.** In the property sheet of the Name item, set the CLASS to G\$_NAME_CLASS. The Visual Attribute on the Name item should be set to G\$_NVA_TEXT_ITEM.
- 8.3.** Any person form such as SOAIDEN is executed by the trigger KEY-LISTVAL, and any non-person form such as SOACOMP is executed by KEY-CQUERY. If the ID item uses such a triggers, its auto hint text must contain the words 'LIST' to reflect the trigger KEY-LISTVAL and 'COUNT HITS' to reflect the trigger KEY-CQUERY.

The KEY-NEXT-ITEM trigger of an ID item, contains the following procedure:

```
G$_IDNAME_SEARCH.ID_SEARCH(parm1);  
where parm1 = 'ID'
```

- 8.4.** The KEY-NEXT-ITEM trigger of a Name item, contains the following procedure:

```
G$_IDNAME_SEARCH.ID_SEARCH(param1);  
where param1 = 'NAME'
```

The PRE-TEXT-ITEM trigger of a Name item, contains the following procedure:

```
G$_IDNAME_SEARCH.DISABLE_NAME_ITEM
```

- 8.5.** If the Name item allows free-format entry, then the CLASS assign in the Name item of the property sheet is G\$_FF_NAME_CLASS.

Code and Description Items

To enable the search mechanism to a Code and Description items to validate codes and descriptions against information stored in tables, the items undertake the following steps:

State changes: If the form is a query-only form, the property 'Update Allowed' of the code item must be set to FALSE.

If the Description item is associated with a database table, do not attach a property class to the description. Otherwise, make these changes in the Description item property sheet

- 8.1.** In the property sheet of the Code item, set the CLASS to G\$_CODE_CLASS.
- 8.2.** If the Code item will associate an LOV that conforms to all the following standards, the G\$_SEARCH_PARAMETERS does not need to be created as trigger under the code item

- i) LOV is named like `tablename_LOV`.
- ii) LOV table name has columns named `tablename_CODE` and `tablename_DESC`.
- iii) LOVs associated record group does not have a WHERE clause.

If the above conditions are NOT met, then the user-defined trigger G\$_SEARCH_PARAMETERS at the Code item level must be created. This trigger will have the following code:

```
G$_SEARCH.PARAMETERS ('param1', 'param2', 'param3');  
where
```

```
param1 = database column name from the validation table for code  
param2 = database column name from the validation table for description  
param3 = WHERE clause from the record group associated with the LOV  
(optional)
```

- 8.3.** The KEY-NEXT-ITEM trigger, contains the following procedure:

```
G$_SEARCH.CODE_KEY_NEXT_ITEM;
```

8.4. The POST-TEXT-ITEM trigger, contains the following procedure:

```
G$_SEARCH.POST_TEXT_CODE;
```

8.5. The WHEN-NEW-ITEM-INSTANCE trigger, contains the following procedure:

```
G$_SEARCH.CODE_WHEN_NEW_ITEM_INST;
```

8.6. The WHEN-MOUSE-DOUBLECLICK trigger, contains the following procedure:

```
G$_SEARCH.WHEN_MOUSE_CLICK;
```

8.7. To create functionality to be executed by the event right button mouse click, create under the Code item the trigger G\$_SEARCH_OPTIONS.

If a displayable description item is associated to a code item and the description item is not associated to a database table, then the class G\$_DESC_CLASS needs to be assigned to the 'Class' attribute of the description item. Furthermore, the Visual Attribute 'Default' must be assigned.

Dates

Items of data type DATE need to undertake the following steps:

1. To create an item of type date, assign the property CLASS G\$_DATE_CLASS.
2. To create an item of data type DATETIME, assign the property CLASS G\$_DATETIME_CLASS.
3. Set the default value in the property sheet of the item to \$\$DBDATE\$\$.

Iconic Button

Iconic buttons are buttons that has the G\$_ICON_BTN_CLASS assigned to the class property of the button. It also has the Icon Name set to one of the names from the general/icon directory.

Flashlight Button- itemname_btn

Flashlight buttons are a type of iconic button that has the icon name set to flashlit

Check Box, Radio Group

For check boxes and radio groups, if the item is a database field, the name of the radio groups or check boxes will be the item name. If not database fields, follow the naming conventions above. The visual attribute needs to be set to 'Default' in the property sheet of the check box or radio group.

Menu Bar Options

The Menu Bar is an Oracle built-in residing at the top of the MDI window. It is an attribute of a form. It contains Options that allow navigation between blocks and forms, and it performs queries and calculations. The Options are displayed by block and they are keyed-in using the GUAOPTM form. Its code is enclosed in the G\$_NAVIGATION_FRAME package. The following is a list of relevant procedures that must be used by the user to manipulate Options:

Disabling an Option

```
G$_Navigation_Frame.Disable_Option(parm1, parm2)
```

Where parm1 = Called Object field in GUAOPTM Form
parm2 = Type Indicator field in GUAOPTM Form

Enabling an Option

```
G$_Navigation_Frame.Enable_Option(parm1, parm2)
```

Where parm1 = Called Object field in GUAOPTM Form
parm2 = Type Indicator field in GUAOPTM Form

Changing the Label Text of an Option

```
G$_Navigation_Frame.Set_Description(parm1, parm2, 'string')
```

Where string specifies the label of the option
parm1 = Called Object field in GUAOPTM Form
parm2 = Type Indicator field in GUAOPTM Form

Reading the Label Text of an Option

```
G$_Navigation_Frame.Get_Description(parm1, parm2)
```

Where parm1 = Called Object field in GUAOPTM Form
parm2 = Type Indicator field in GUAOPTM Form

For more information on Unified Modeling Language, please see the following references:

1. Jesse Liberty, Beginning Object-Oriented Analysis and Design with C++, Wrox Press Ltd, UK, 1998.
2. Scott W. Ambler, The Unified Modeling Language v1.1 and Beyond: The Technique of Object-Oriented Modeling, White Paper modified from Building Object Application That Works, Cambridge University Press, 1998
3. Object-Oriented Programming Concept: A Primer, unknown, White Paper, 1999
4. Pierre-Alain Muller, Instant UML, Wrox Press Ltd., UK, 1997

Standards for Forms

This section describes the Banner design and navigation standards currently in use.

Naming Conventions

Canvas - description_canvas

Button - description_btn

Standard buttons:

```
<window>_exitvalue_btn  
<window>_rollback_btn  
<window>_save_btn  
<window>_exit_btn
```

 **Note**

The sequence number from the conversion is the forms 3.0 page number. ■

LOV Button - field-name_lbt

Non-LOV buttons may also have a suffix of '_lbt' to take advantage of the standard code in the `WHEN_BUTTON_PRESSED` trigger. The button must be associated with an item with the same name as the button. The button name would include the '_lbt' at the end. Example: The ID item might have a button named `ID_LBT`.

Record Group - description_rg

 **Note**

LOV and Record groups may retain the name they are converted with, which may not conform to standards. These objects may be replaced by referenced objects. ■

Window Name - description_window or root_window

Alert Window - description_alert

Check Box - description_cbox (see Note below)

Radio Group - description_radio (see Note below)

 **Note**

For check boxes and radio groups, if the item is a database field, the name of the radio groups or check boxes will be the item name. If not database fields, follow the naming conventions above. ■

Visual Cues

Modification ID

A number of institutions prefer to customize Banner forms. However, this may make it difficult to know if the form being displayed is the SunGard-delivered version or the custom version.

To help you identify your custom forms, you can set up Banner to display a modification ID number in brackets on the title bars.

 **Note**

This feature does not perform version control of any kind; it merely identifies the form as being custom. ■

The modification number also appears on the About Banner Form (GUAABOT).

To enable this feature:

1. Access the General User Preferences Maintenance Form (GUAUPRF).
2. Select the **Display Release Number on Title Bar** check box, if it has not been selected already.
3. Save your changes.

 **Note**

The modification number will not appear on the title bars if you clear the check box on GUAUPRF. However, it will still appear on GUAABOT. ■

4. In the form in which you want to enable this feature:
 - 4.1. Add a `text_item` to the `FORM_HEADER` block.
 - 4.2. Name this `text_item` `MOD_ID`.
 - 4.3. Set the *Enabled Property* of `MOD_ID` to *No*.
 - 4.4. Set the *Max Length* to 16.
 - 4.5. Provide a value from 1 to 16 alphanumeric characters for the `FORM_HEADER.MOD_ID` in the form-level trigger `LOAD_CURRENT_RELEASE`.
5. Save your changes.

The value you entered will appear in the title bar of that form and on GUAABOT.

Instance Name

The instance name will appear on the window bar in all windows. The instance name will be enclosed in parenthesis one space after the release number. The release number should be entered on each root window title as boilerplate. (Refer to the Windows section of this document for more information.)

The `G$_SET_INST_PROPERTY` procedure is in the `WHEN-WINDOW-ACTIVATED` trigger and will manipulate the window title by adding the eight-character instance name to the end. `Load_current_release_trigger` contains the release number.

Forms with key information will have a solid line after the key information to distinguish it from the data block. The line should be drawn with the solid line (1 point width) on the tool bar and extend the full width of the form.

Guideline

When a window includes only one block other than the key information, a block title is not needed for the data block.

Where there are multiple blocks on a window, center the name of the block in mixed case, and enclose in a box. The box should be a solid line with 1 pt width.

Note

The solid lines extending from the titles should be drawn with the solid line on the tool bar, 1 pt width. The lines should be centered with the text using the Align Vertical function under the Arrange option in the layout editor. ■

The form title, centered and in mixed case, appears in the window bar with the seven character mnemonic in upper case followed by the release number. The eight-character instance name is added after the window information and enclosed in parenthesis. Root window format - Centered and in mixed case: Form Title (Mnemonic^release number)^(instance name). For example:

```
Person Identification Form (SPAPERS 6.0) (SEED)
```

Non-root window titles will have the same format replacing the form name with the window title in mixed case. The rest of the title bar is in the same format as the root window bar. For example:

```
Address (SPAIDEN 6.0) (SEED)
```

Windows should have one blank line at the top and bottom and one space on each side if possible. This applies to both root and secondary windows. There is one exception; the words “Confidential” and “Deceased” may appear in the top line.

Standard full-size window size is 473 x 328. There may be exceptions to this rule. An exception might be a form that is frequently called and it would be helpful to keep the calling form visible.

Non-full screen windows should be centered under the key information and be context sensitive. For those windows where this is not appropriate, discretion should be used to appropriately place the window to not overlay pertinent information. For example, you may not want to overlay the window bar on the root window that contains the form name. Likewise, it may be appropriate to always display the key information.

Non-full screen windows should be smaller than the root window where possible. If they need to be almost full size, make them 473 wide to fit inside the boundaries of the root window.

Helpful Hints

When a form that is called from another form needs to be sized so that it does not overlay the key information of the calling form, the canvas of the called form that is to be resized cannot be associated with the root window. If the desired canvas is associated with the root window, it will overlay the entire calling form.

Blocks

Block property sheet values:

Key Mode	Unique_Key
Locking Mode	Immediate
Recs Buffered	Twice the number displayed
Navigational Style	Same_record (default, change if necessary)
Key Information	Key information will exist on the root window of each application form where appropriate. The key information may be overlaid with windows if space is needed or the key information data is not pertinent to the active windows.
Block Title	Block titles should identify the data being displayed; however, unlike previous Banner standards, the word 'block' should not appear in the block title.

Scroll Bars

Scroll bars should be on the right side of the form. They should be two characters wide. If they correspond to a boxed area, the scroll bar should be inside the box on the right hand side.

The length of the scroll bar should start at the first row and extend to the last row that scrolls. It should not go beyond rows being displayed. However, if the number of rows displayed is two or less, the scroll bar should extend up into the column heading to display the indicator button on the scroll bar.

Scroll bars on validation forms should start in position 450 and be two characters wide.

Navigation

The key information items should be disabled once the cursor leaves the key information. This is accomplished via the `DISABLE_KEYS` trigger executed in the `WHEN_NEW_BLOCK_INSTANCE_TRG`. The Rollback function must be pressed/selected to re-enter the key information. Re-enable items/buttons in the key information via the `ENABLE_KEYS` trigger executed in the `KEY_CLRFRM` trigger.

The Rollback function should close any windows that are open via a user defined `CLOSE_WINDOWS` trigger executed in the `KEY_CLRFRM` trigger. The root window is an exception and should remain open. Other windows may also be an exception, however, data in ALL open windows must be cleared when the cursor is in the key information.

Using the `WHEN_WINDOW_ACTIVATED_TRG` trigger, each form must include code to move the cursor to a newly activated window and out of a closed window because of character mode. The cursor should go into the first enterable item in the window or the item that is “clicked” into to activate the window.

The `next_item` trigger on the last item of a window and the `PREVIOUS_ITEM` trigger on the first item in a window should keep the cursor within the window. There may be exceptions to this to allow the user to tab out of the window.

Text Items

Numeric items should use an edit mask with dollar signs, a decimal point, and commas where appropriate and space allows. The edit mask is entered on page two of the item property sheet. These items should also be right justified.

Abbreviations should be eliminated and the tags spelled out where possible striving for consistency throughout each product as well as the system.

Some standard tag changes for international clients:

- Change *State* to *State/Prov*
- Change *ZIP code* to *ZIP/PC* (for Postal Code)
- Change *SSN* to *SSN/SIN/TFN*
- Change *1099 Id* to *Tax ID*

These changes need to be reflected in dynamic help and auto help.

Item tag names that appear to the left of items should be left aligned. (This is a change from the previous Banner standard.) Display and text items should be aligned where possible for aesthetically pleasing “windows”. Tag names that appear at the top of a column should be centered over that column (with no colon) as space permits.

Tag names to the left of a text item should include a colon. Tag names on the top of columns should not include a colon.

Text/Display items should be at least one space apart.

Boxes should be used to group data items at the product's discretion. If boxes are used to group data items, boxes with square corners should be used. Rounded corners do not show in character-mode.

Boilerplate that is to the left of a text item should be centered vertically with the item using the Align function on the property layout sheet. Column headings should also be centered with other column headings on the same line and centered above the column itself.

Check Boxes, Radio Groups, Pull Down Lists

Check Boxes

Check boxes should be used when there are two obvious choices where only one box is needed.

Example:

Confidential would be selected for *yes* or cleared for *no*. **Active** would be selected for *active* or cleared for *inactive*. If the field is required, a default value must be specified.

Indicators on validation forms that have two obvious choices should be made into check boxes if appropriate. Autohelp needs to be modified appropriately. Change the tag to be indicative of what the selected box means and change the auto help to say check for *xxxxx*.

Example:

In Advancement, an indicator is selected if the code indicates an alumni. The tag should be **Alumnus**, the auto help should be changed to *Alumnus; check for alumnus*.

Check boxes should be three characters wide.

Radio Groups

Radio groups should be used with ≤ 3 exclusive choices.

Check Boxes/Radio Group Tags

Check boxes/radio group tags should be boilerplate and not the label associated with the item. Using the associated label does not adopt the color of the background making the entire item, including labels, all white.

The recommended placement of tags on check boxes and radio groups is to the right of the radio button or check box. The tag or check boxes must be placed up against the check box. This may be changed where appropriate.

Pull-Down Lists

Pull-down lists should be used when there are more than three exclusive choices. The list size should be three larger than the length of the label for character mode. A null value in a pull-down list should be represented by the word *none* with parentheses around it (*None*). *None* by itself may be a valid selection. Any extra blank lines in the pull down lists should be removed.

Buttons

The text within a button should be in mixed case. Exception examples: If *OK* or *ZIP/PC*, is used, it should be in upper case.

All buttons need to be expanded two characters greater than the label text to allow for character mode parenthesis.

Buttons that appear on the top of a column should not include a colon.

Buttons should be aligned vertically as appropriate. Buttons that are aligned vertically (in a column) should be the same size. This applies to LOV buttons as well.

Application specific buttons added to the button control block on the same line as the standard buttons should appear immediately to the left of the standard buttons. Application specific buttons may be larger than 10 if needed.

Button Properties

Displayed - On

Enabled - On/Off (as appropriate)

Navigable - Off (Oracle's initial default is On)

Auto Hint - Off

Mouse Nav. - Off (Oracle's initial default is On)

Default Btn - On/Off (as appropriate)

Iconic - Off

LOV/LOV Buttons

The tag for an item that has LOV available should be the LOV button itself.

LOV buttons for a repeating block should reside in the block with the LOV field rather than the button control block. The button needs to be added only once and will repeat with each row.

LOV buttons that appear to the left of the item should contain the tag, followed by a colon and enough spaces to left justify the tag, with one space between the button and the LOV field. If the tag fits into the button with no extra spaces, add two additional characters to the width for character mode. Add spaces to the end of the label to left-justify the tag within the button.

Example:

If the LOV button is six characters and the tag is *State*: the button should be increased to eight characters *State*: for formatting. The button should be one space away from the LOV item.

An LOV should have the following properties:

Auto confirm - On

Auto display - Off

Menus

Oracle has supplied a default menu to be used with Forms. The Oracle default menu has been enhanced for Banner applications by the addition of the Options selection on the menu bar, the addition of “Dynamic Help,” “About Banner,” and “Display Image” under the Help selection, and “Banner,” “Direct Access,” “QuickFlow,” and a “Close” selection for character mode under Action.

The custom Banner menu is **gumappl.mmx**. The navigation frame contains an Options selection. The Options menu selection features:

- All accessible windows (except for the main window), external forms, and other processes. Since there are several ways to return to the root window (rollback, previous block, and window menu pick), the main window should not be included in the menu.
- If triggers are created for menus, the trigger to be executed should reside in the form with the standard name MNU_XXX_YYY_ZZZZZ, where MNU_ identifies

the trigger as a menu trigger, and standard XXX_YYY_ZZZZZ is free-form text which clearly identifies the menu being called or executed.

Example of user-defined triggers for menu selections:

```
MNU_OPT_FRM_SPAPERS
MNU_OPT_WIN_ADDR
MNU_OPT_PRO_ADMIN
```

Not all menu options will have corresponding function keys such as Options and Help. The main window should not appear as an option in the menu.

Any form level navigation represented as a button added to the form should also be added to the options selection bar menu. (See Option menu below regarding the GUROPTM table for further instructions.)

Some previously-available options were eliminated from the Options menu on some forms. These changes were made because VGA display for Windows allows only 24 options per data stack and no scrolling feature exists. In creating custom options, any items with a sequence number that begins with 1 are considered internal to the form, and appear above the dotted line. Items with any other number are external to the form and appear below the dotted line. A maximum of 23 items can appear.

An option under the HELP menu selection was added to replace the form header, "About Banner". This option activates a window which displays the full institution name that used to appear in the form header and the current release number.

Menu property sheet values:

Type - Plain or Separator
Cmd - Menu for sub-menu picks
Null for separator
PL/SQL for others

Helpful Hints

When calling a form from another form, use G\$_secured_form_call so that role security is invoked.

The block name and description for all blocks in the form were inserted into GUROPTM. If there was only one item in the block the entry was determined to be a call to a form. If there was more than one item in the block the entry was deemed a navigable block. In this case the first item in the block was put into the table as the "go to" item.

GUROPTM Fields

GUROPTM_SORT_SEQ	Sort sequence number using decimals to provide a sort within groups Blocks and windows start with 1.x, form calls with 2.x, and processes with 3.x.
GUROPTM_TYPE_IND	Type indicator - (W)indow, (B)lock, (F)orm, (P)for trigger, (L) Form with Select turned off
GUROPTM_FORM_NAME	Current form name
GUROPTM_NAME1	Name of form, window, block, process to invoke or navigate to.
GUROPTM_NAME1_DESC	Description for NAME1 that appears in the menu. The format is the process being done. Example: Add an ID
GUROPTM_NAME2	Name of item to navigate to if NAME1 is block or window. This must be in the form of block.item since the procedure issues a GO_ITEM to get there.
GUROPTM_CAPACITY	For forms only, type of call - (M)aintenance or (Q)uery
GUROPTM_TRG_NAME	For processes, enter the name of the trigger to be executed. It can be a user defined trigger or a built-in. Only gets executed if GUROPTM_TYPE_IND = 'P'.
GUROPTM_TRG_TYPE	Type of trigger TRG_NAME is - (U)ser named or (B)uilt-in. If set to 'U' then an EXECUTE_TRIGGER will be executed for TRG_NAME, otherwise it will do a DO_KEY for TRG_NAME.
GUROPTM_BLOCK_VALID	If valued, this entry will only show up ONLY when the cursor is positioned in the block with this name.

Note

The code for the menu procedures is in the checklist notes. ■

Review your data using the GUAOPTM form and the make necessary corrections. Remove the entry for the key information. Entries must be added/corrected for “internal” (windows) and “external” (forms and processes) items as needed.

Miscellaneous Notes

Table owners need to be removed when referencing tables and views in triggers. Owner names need to be used for referencing procedures.

Each product must modify the LOVs in their xOQOLIBs to make the column heading tag names more friendly. Activity date may display without centuries.

Creating Custom Banner Forms

Follow this checklist when creating custom Banner forms.

1. Name your form following the Banner object naming standards. See the *Banner Getting Started Guide* for the detailed standards for 7-character Banner object names.
2. Follow the coding standards described in this chapter.
3. Make sure to include the correct calls to Banner Security (see “Modifying Local Forms” in the *Banner Security Administration Handbook*.)
4. Create the form object and place it in the correct file path. (See “Directory Structure” in Chapter 1 of this manual.)
5. Next you must define the form to Banner using the GUAOBS form. Make an entry for the new object and give it a name, description, type, system indicator, and so on. See Banner Online Help for details on GUAOBS.

Once you have defined the form in GUAOBS you will be able to access it via the Direct Access field in Banner without getting this error: *Invalid object name entered*.

6. Define the form as a new object in Banner Security. See the *Banner Security Administration Handbook*.
7. Grant security access to the object to one or more user IDs or classes. See the *Banner Security Administration Handbook*.
8. Set up FGAC restrictions for the new object, or exempt it from FGAC processing if desired. See the *Banner Data Security Handbook* for details.
9. Use GUTGMNU to update Banner menus to add the new form, if desired. See the *Banner General User Guide* for details.
10. Log into Banner with a user ID that has security access to the new object and test access to the object.

Guidelines for Updating Forms for Banner 8.0

Every baseline Banner form was updated and redelivered for Release 8.0 to support new Internationalization standards and new product-wide features. If you are manually

updating a 7.x form, follow this checklist to make sure that your form conforms to Banner 8.0 standards.

Step 1 Create an 8.0 Audit Trail Entry

In the form's audit trail, create a new entry for version 8.0.

Step 2 Modify the load_current_release trigger

Modify the `load_current_release` trigger for a current release of 8.0.

Step 3 Check WHEN-NEW-RECORD-INSTANCE

If your form has a `WHEN-NEW-RECORD-INSTANCE` with a hierarchy property of *OVERRIDE*, change the hierarchy property to *AFTER*.

This change is necessary so that your form will work with the new Supplemental Data Engine.

Step 4 Add Support for Tooltips

Banner 8.0 introduces support for tooltips on data fields where the data values may be too long to fully display in the field.

Check each text item on your form. If an item has a class of `G$_GRADE_CODE_CLASS`, `G$_CODE_CLASS`, `G$_ID_CLASS` or `G$_NAME_CLASS` it will automatically inherit the tooltip feature. If a text item does not have one of those four classes, then add one of the following classes:

- For a normal, single-line field, add `G$_CHAR_FIELD_CLASS`
- For a multiline text field, add `G$_CHAR_MULTILINE_FIELD_CLASS`

Step 5 Observe Standards for Field Lengths

For Banner 8.0, new standards were established for fields containing certain kinds of data, and many fields were expanded to match these new standards.

Check the fields in your form to see if any of these length standards apply.

Field	Standard Length for Banner 8.0 Forms
First Name (<code>_FIRST_NAME</code>)	60
Middle Name (<code>_MI</code>)	60
Last Name (<code>_LAST_NAME</code>)	60
Legal Name (<code>_LEGAL_NAME</code>)	500

Field	Standard Length for Banner 8.0 Forms
Street Address Line 1 (_STREET_LINE1)	75
Street Address Line 2 (_STREET_LINE2)	75
Street Address Line 3 (_STREET_LINE3)	75
City (_CITY)	50
ZIP (_ZIP)	30
Area Code (_PHONE_AREA)	6
Telephone (_PHONE_NUMBER)	12
Extension (_PHONE_EXT)	10
E-mail Address (_EMAIL_ADDRESS)	128
SSN (_SSN)	15
Any field that holds currency values	17,2
Currency Conversion Rate (_CONV_RATE)	17,7





Global Variables

A global variable can store a character string value of any length. Global variables can be used to store data values outside the blocks of a form, especially to pass information from one form to another when one form calls another form. All global variables have the format:

```
GLOBAL.var_name
```

where *var_name* is a valid Oracle object name. `GLOBAL.var_name` is never interpreted as a reference to a block called GLOBAL.

Global variables do not have to be explicitly declared or defined; they are established when either the COPY or DEFAULT command is used or direct assignment is used to assign a value. For example, the following command assigns the value of *N* to the variable GLOBAL.INITF:

```
##COPY 'N' GLOBAL.INITF := 'N'
```

Global variables remain defined for the duration of an Oracle Developer Forms session, or until the #ERASE command is used to remove them.

The GUAINIT form establishes the General global variables along with any product-specific globals for each product currently installed. The following are some of the General global variables that GUAINIT establishes:

GLOBAL.CURRENT_DATE	Current Date. Default is TO_CHAR(SYSDATE, 'DD-MON-YYYY').
GLOBAL.CURRENT_TIME	Current Time. Default is TO_CHAR(SYSDATE, 'HH24:MI:SS').
GLOBAL.CURRENT_USER	Current User. Default is USER system variable.
GLOBAL.HELP_CALL_FORM	Help Call Form. Default is GUAHELP.
GLOBAL.HOSTCMD	Host Commands. Host commands to be submitted. (Only valid in character mode.)

The following global variables are established when Dynamic Help is requested:

GLOBAL.HELP_BLOCK	Help Block. Current block in which the cursor resides when Dynamic Help is called.
GLOBAL.HELP_FIELD	Help Field. Current field in which the cursor resides when Dynamic help is called.
GLOBAL.HELP_FORM	Help Form. Current form in which the cursor resides when Dynamic Help is called.
GLOBAL.INDEX	Index. Dynamic Help index indicator, default is H for Help.

The following global variable is established when exiting a validation form by using the “exit with value” option:

GLOBAL.VALUE	Value. Value of the Validation Table Code returned by the Exit with Value key.
--------------	--

General Global Variables

The global variables for Banner General are stored in GUAINIT.FMB. This is the form that is triggered whenever a user starts Banner. The global variables used in the session are unique for that user.

How PIDMs and IDs are Generated

A PIDM (person identification master) is Banner's unique identifier for a person (or non-person entity) known to the system. For data integrity, it is important that the one-to-one correspondence between PIDMs and persons is maintained.

Prior to Release 7.0, Banner generated new PIDMs and other IDs with the SOBSEQN table and its associated routines. When a new PIDM was needed, Banner selected and updated the current number from SOBSEQN to get the next available number. This approach, originally designed to handle PIDMs, has been extended to accommodate other types of IDs and transactions.

The introduction of the Banner Messaging Gateway application, which processes incoming messages and calls multiple Banner APIs within a single Oracle transaction, increased the likelihood that the SOBSEQN table would be locked (in the middle of generating a PIDM for another user) when needed. The locking problem resulted in the failure to produce synchronization messages from a message-enabled form.

In Release 7.0, the SOBSEQN method of incrementing PIDs and IDs was replaced by another method to accomplish the same function. A new Identification API handles inserting new IDs and PIDs into the SPRIDEN table. The Identification API uses Oracle sequences to determine the next available number for the ID or PID.

This approach eliminated the locking contention problem and greatly improved system performance. Once a sequence is defined, it can be accessed and incremented by multiple users with no waiting. The Oracle sequence does not need to complete the previous transaction before the sequence can be incremented again. This allows for nearly simultaneous transactions for all users.

ID_SEQUENCE is the Oracle sequence that generates unique identification numbers such as SPRIDEN_ID. PIDM_SEQUENCE generates unique internal identification numbers such as SPRIDEN_PIDM. Two scripts, gos_id_seq.sql and gos_pidm_seq.sql, create the new Oracle sequences.

Note that using sequence generators may cause gaps in the sequence if an application selects .NEXTVAL and subsequently fails to store it.

The *Oracle Application Developer's Guide* explains how to manage sequences.

To select the next value from the sequence and increment it you can:

```
Select PIDM_SEQUENCE.NEXTVAL from dual;
```

To examine the next value without incrementing it:

```
Select PIDM_SEQUENCE.CURRVAL from dual;
```

You must drop and recreate the sequence to change the starting number.

During the 7.0 upgrade process, the current values on the SOBSEQN table will be used as the initial settings for the new sequences.

There are two functions, F_GENERATE_ID and F_GENERATE_PIDM, in the GB_COMMON package, to manage generating new IDs and PIDs. All forms and processes that create new SPRIDEN records call the P_CREATE procedure in the GB_IDENTIFICATION package. P_CREATE in turn calls F_GENERATE_ID or F_GENERATE_PIDM as needed.

F_GENERATE_PIDM, when called, will select the next number from PIDM_SEQUENCE, then check to see if that PIDM is already in use in SPRIDEN. If it is, it continues to select the next number until it reaches a number not in use. This self-corrects for any discrepancies between the sequence's next available number and what is actually stored in SPRIDEN. Therefore, using F_GENERATE_PIDM will eliminate the *Duplicate Generated PIDM* error.

Filling Gaps in PIDM or ID Number Series

When some schools initially bring up Banner, they assign historical records to a series of ID numbers, for example, 1 through 200000. Then, they reset the sequence numbers to some higher number, for example, 1000000, so old records are easily identified by the ID

number range, and a gap exists between the highest old number and the lowest new number.

It is possible to use the new sequence to fill in any historical gaps left in a PIDM or ID number series. For example, to fill gaps in a series of ID numbers:

1. Drop ID_SEQUENCE.
2. Recreate ID_SEQUENCE with a starting number of 1
3. Create the next SPRIDEN record using any Banner 7.0 application.

All Banner applications call the F_GENERATE_ID function (and F_GENERATE_PIDM, of course) when a new person record is created. The function will run its sequence generator up through all the existing numbers until it encounters the gap and return a valid unused number. This may take some time on the very first record created, but after that the system will continue incrementing the numbers and filling in any gaps.

The SOBSEQN Method Used in Release 6.x

In Banner 6.x (and prior versions), IDs and PIDM numbers were generated when needed by using one-up numbers from the Banner Sequence Number Table (SOBSEQN). This table stores the maximum sequence number currently used so that the next available number can be determined.

SOBSEQN was used to generate sequence numbers for IDs and PIDMs as well as for many other purposes in Banner, including receipts and alumni gifts. The various sets of numbers are distinguished by SOBSEQN's Function column.

When a new ID or PIDM was needed, Banner retrieved the Maximum Sequence Number for the specified function and added one to the number. The result was stored in the Maximum Sequence Number column so Banner was ready to generate the next sequence number. If a sequence number prefix was used (such as for generated IDs), this value was also retrieved from the SOBSEQN table and concatenated with the sequence number.

With Release 7.0, SOBSEQN is no longer used to generate IDs and PIDMs, but the table will still be used to maintain sequence numbers for other functions.

Banner Libraries

GOQOLIB

GOQOLIB contains procedures used in multiple forms across the Banner products. It is used as a library repository to store referenced triggers, blocks, windows, canvases, visual

attributes, and items. These procedures used in conjunction with the GOQRPLS PL/SQL library contain the building blocks for the Banner system. The procedures are referenced into the source code and become part of the programs. Changes made to the GOQOLIB will be applied to all programs when they are regenerated.

Banner uses Referenced Procedures so that commonly executed logic can be maintained in one location rather than be repeated in multiple forms. Procedures that are used by multiple Banner systems are found in the library and are listed below.

GOQRPLS

The GOQRPLS PL/SQL library includes the following procedures.

Name	Function
G\$_ADD_TO_PERSONAL_MENU	Adds the current form to a user's personal menu.
G\$_B2K_WIN_HELP	This is a package used to determine whether help exists and how to display it.
G\$_BLOCK_EXISTS	Checks if a block exists.
G\$_BTN_PRESSED	Executes built-in subprogram associated with appropriate button.
G\$_BUILD_FULL_NAME	Builds name to support ID field validation.
G\$_BUTTON_PROC	This is a generic button procedure. It reads the NAME of the button and performs a DO_KEY(<i>item_name</i>).
G\$_CHECK_ACCESS	This is a new function to check whether a user is authorized to access a program/process via job submission.
G\$_CHECK_FAILURE	Procedure that checks for form success.
G\$_CHECK_IF_DUP_PIDM	Checks for duplicated PIDM.
G\$_CHECK_QUERY_MODE	Procedure that sets global to 1 if the form is in query mode; else 0.
G\$_CHECK_STATUS_QUERY	Used to check whether the most recently executed built-in has succeeded (COMMIT_FORM OR POST).

Name	Function
G\$_CITY_STATE_NATN	Defaults city, state, nation, and country codes when a ZIP/PC code is entered.
G\$_CITY_STATE_NATN2	This function is similar to above function but it also set the Global.Zip value for subsequent call to the GTVZIPC form.
G\$_CITY_STATE_NATN3	Defaults city, state, nation, and country codes when a ZIP/PC code and city are entered
G\$_CHECK_VALUE	Procedure that checks passed string for null values.
G\$_COMPRESS_WORK_NAME	Returns a compressed name field in all uppercase without spaces or punctuation except for the '%', which allows the field to be used in queries. Function can be passed any character field.
G\$_CONVERT_ETHNICITY_CODE	Supports race/ethnicity processing.
G\$_COPY_FLD_ATTR	Procedure which copies a field's x and y coordinates to globals.
G\$_CREATE_METADATA	Retrieves the current window's title, form name, and release number.
G\$_DATA_EXTRACT	Extracts data from a form.
G\$_DATE_CALL_GUACALN	Supports entering date data from the calendar.
G\$_DATE_NEXT_ITEM	Retrieves the next item for a date field.
G\$_DATE_POST_ITEM	Used by date fields which require G\$_DATE_REFORMAT function to insure proper date validation.
G\$_DATE_REFORMAT	Reformatting date.
G\$_DATE_WHEN_NEW_ITEM	Used by date fields which require G\$_DATE_REFORMAT function.
G\$_DECEASED_WARNING	Pops the warning alert for a person who is deceased.

Name	Function
G\$_DEF_VIEW	Sets up the view for pop-up window.
G\$_DETERMINE_CURSOR_LOCATION	Used in multi-window forms to locate the cursor.
G\$_DETERMINE_ERASE_GLOBAL	Erases any globals created by the G\$_DETERMINE_CURSOR_LOCATION procedure.
G\$_DETERMINE_WIN_NOT_PREV_ACTIV	Used in multi-window forms where window to window navigation has no restrictions. This function is called from procedure G\$_DETERMINE_CURSOR_LOCATION.
G\$_DISPLAY_ALERT	Generic call to display an alert window.
G\$_DISPLAY_ERR_MSG	Displays errors passed back from database routines.
G\$_DISPLAY_IMAGE	Displays a stored image file associated with an ID via the GUAIMGE form.
G\$_DISPLAY_LOV	Displays appropriate List Of Values window for the current field and allows the return of the selected value to the calling field.
G\$_DO_NEW_MESSAGES_EXIST	Procedure to check the message table and display a message if the user received a new message since the last time he/she was notified.
G\$_DO_WIN_ACTIVATED	Determine whether or not to execute the remainder of the logic in the when-window-activated trigger based on a form-specific global variable.
G\$_DUPLICATE_PIDM	Checks for duplicate PIDM.
G\$_ENV_IS_CHARMODE	This function returns TRUE in a non-GUI, character-mode environment.
G\$_ENV_IS_GUI	This function returns TRUE in a Graphical User Interface environment.
G\$_ENV_IS_MAC	This function returns TRUE in a Macintosh environment.

Name	Function
G\$_ENV_IS_MOTIF	This function returns TRUE in a MOTIF environment.
G\$_ENV_IS_WEB	This function returns TRUE in a Internet-native environment.
G\$_ENV_IS_WEB_UNIX	This function returns TRUE in a UNIX Internet-native environment.
G\$_ENV_IS_WINDOWS	This function returns TRUE in a Windows environment.
G\$_ENV_IS_WINDOWS3X	This function returns TRUE in a Windows 3.x environment. Note: This will be made obsolete in a future release.
G\$_ENV_IS_WINDOWS95	This function returns TRUE in a Windows95 environment.
G\$_ENV_IS_WINDOWS98	This function returns TRUE in a Windows98 environment.
G\$_ENV_IS_WINDOWS9x	This function returns TRUE in a Windows95 or Windows98 environment.
G\$_ENV_IS_WINDOWSNT	This function returns TRUE in a Windows NT environment.
G\$_ERRORS	This function populates public variables.
G\$_F5_NAVIGATION	Offers navigation options when F5 key is pressed.
G\$_FIND_WINDOW_ID	This function returns the ID of the current event's window.
G\$_FORMS_NLS	Package supports international date formats.
G\$_FORM_SHUTDOWN	This procedure contains the common commands to be executed at form shutdown.

Name	Function
G\$_FORM_STARTUP	This procedure contains the common commands to be executed at form startup.
G\$_FUNC_BASE_INFO	This procedure is called within the General Product Events Module forms (GEATASK, GEAPART, GEAFCOM) to bring up a window of base function information from GEAFUNC.
G\$_GET_MAIN_WINDOW_TITLE	Retrieves the title of the main window.
G\$_GET_PIPE_MESSAGES	This procedure checks for Electronic Approvals messages through the use of a dbms pipe named as the Oracle username. It alerts the user to how many transactions they have pending.
G\$_GET_RW_ATTRIBUTES	Determines attributes of the root window.
G\$_GET_SET_LOCAL_DIR	Used in Job Submission and Graphics modules to define a user's operating system profile, including their default local directory.
G\$_GET_UPRF_BUTTON_COLOR	Checks user preferences for button color.
G\$_GET_UPRF_CANVAS_COLOR	Checks user preferences for the form canvas color.
G\$_GET_UPRF_CM_FORMS	Checks user preferences for common matching.
G\$_GET_UPRF_CODE_PROMPT_COLOR	Checks user preferences for the code prompt color.
G\$_GET_UPRF_CONF_ALERT	Checks user preferences for alerts that information is confidential.
G\$_GET_UPRF_DATAEXTRACT	Checks user preferences for data extract routines.
G\$_GET_UPRF_DEAD_ALERT	Checks user preferences for alerts that a person is deceased.

Name	Function
G\$_GET_UPRF_DE_MIME_TYPE	Checks user preferences for the type of file to be created in the data extract process.
G\$_GET_UPRF_DE_PROMPTS	Checks user preferences for whether to include column headings in data extract files.
G\$_GET_UPRF_DUP_SSN_ALERT	Checks user preferences for whether or not to display an alert for a duplicate Social Security Number.
G\$_GET_UPRF_EXIT_ALERT	Checks user preferences for a prompt before exiting Banner.
G\$_GET_UPRF_HELP	Checks user preferences for the location of online help.
G\$_GET_UPRF_IMAGE_DIR	Checks user preferences for the location of images.
G\$_GET_UPRF_LINKS_CANVAS_COLOR	Checks user preferences for the canvas color of links.
G\$_GET_UPRF_LINKS_DESC1	Checks user preferences for the text of “My Links” item 1.
G\$_GET_UPRF_LINKS_DESC2	Checks user preferences for the text of “My Links” item 2.
G\$_GET_UPRF_LINKS_DESC3	Checks user preferences for the text of “My Links” item 3.
G\$_GET_UPRF_LINKS_DESC4	Checks user preferences for the text of “My Links” item 4.
G\$_GET_UPRF_LINKS_DESC5	Checks user preferences for the text of “My Links” item 5.
G\$_GET_UPRF_LINKS_DESC6	Checks user preferences for the text of “My Links” item 6.
G\$_GET_UPRF_LINKS_MY_INST	Checks user preferences for “My Institution” link.
G\$_GET_UPRF_LINKS_PROG1	Checks user preferences for the URL or destination of “My Links” item 1.

Name	Function
G\$_GET_UPRF_LINKS_PROG2	Checks user preferences for the URL or destination of “My Links” item 2.
G\$_GET_UPRF_LINKS_PROG3	Checks user preferences for the URL or destination of “My Links” item 3.
G\$_GET_UPRF_LINKS_PROG4	Checks user preferences for the URL or destination of “My Links” item 3.
G\$_GET_UPRF_LINKS_PROG5	Checks user preferences for the URL or destination of “My Links” item 4.
G\$_GET_UPRF_LINKS_PROG6	Checks user preferences for the URL or destination of “My Links” item 6.
G\$_GET_UPRF_MSG_CANVAS_COLOR	Checks user preferences for the canvas color of the broadcast message window of the main menu.
G\$_GET_UPRF_PROMPT_COLOR	Checks user preferences for the color of popup windows.
G\$_GET_UPRF_RECORD_COLOR	Checks user preferences for the color of highlighted records.
G\$_GET_UPRF_SCROLLBAR_COLOR	Checks user preferences for the color of scrollbars.
G\$_GET_UPRF_SEPARATOR_COLOR	Checks user preferences for the color of separators.
G\$_GET_UPRF_STARTUP_MENU	Checks user preferences for the default expanded menu.
G\$_GET_UPRF_TREE_CANVAS_COLOR	Checks user preferences for the canvas color of the menu tree.
G\$_GET_UPRF_VALUE	Supports other user preference functions by retrieving the specific user preference value, or institutional preference value if no user preference value exists.
G\$_GET_UPRF_WEBBKSHLF	Checks user preferences for the location of the Bookshelf.
G\$_GET_UPRF_WEBHLP	Checks user preferences for the location of web help.

Name	Function
G\$_GET_UPRF_WEBOUTPUT	Checks user preferences for the web server database location for database procedure execution
G\$_GET_UPRF_WEBRPT	Checks user preferences for the location of reports on the web.
G\$_GET_UPRF_WEBRPT_SERVICE	Checks user preferences for the report service name for RUN_REPORT_OBJECT.
G\$_GET_WIN_PROPERTY	This procedure returns the Height, Width, and Position of the current window.
G\$_GOQOLIB_FUNC_INFO_BLOCK	Displays basic function information (i.e., from GEBFUNC) on event forms (i.e., GEATASK, GEADART)
G\$_GOQOLIB_KEY_TRIGGER	This defines the standard key functions, such as Key_Up and Key_Exit.
G\$_GOQOLIB_OPT_BLOCK	This defines commonly used option block procedure.
G\$_GOQOLIB_PP_TRIGGER	This defines commonly used pre/post form triggers.
G\$_GOQOLIB_USER_TRIGGER	This defines commonly used key functions.
G\$_GUAHELP	Procedure to call GUAHELP.
G\$_GUAMENU_CHECK_SET	Disables the Select button and menu item when the form is called from GUAMENU.
G\$_HELP_SETUP	Sets global for use in GUAHELP form
G\$_IDNAME_SEARCH	Package used for the new ID/Name search logic.
G\$_IMG_DRIVER	Supports Banner Document Management Suite (BDMS) activities invoked from within Banner.
G\$_INS_UPD_LOCAL_DIR	Routine to insert/update the user's profile for print destination.

Name	Function
G\$_INVALID_FUNCTION_MSG	Shows message for invalid key strokes.
G\$_INVOKE_CM	Checks whether the user is required to use the Common Matching form (GOAMTCH) when creating an ID, and brings up GOAMTCH if required.
G\$_KEY_OPT_MENU	Invokes the key option list window.
G\$_LAST_TEN	This updates the Globals used to populate the Last 10 Forms list under the Action item in the Menu Bar.
G\$_LIST_VALUES_CALL	This procedure calls the appropriate 'TV' validation form for the current item.
G\$_LIST_VALUES_COPY	Copies the value back from 'TV' form.
G\$_LOAD_FORM_HEADER	Copies the heading information.
G\$_MASKS	Determines if masking rules exist for a form.
G\$_MENU_BAR	Routines to set the menu settings.
G\$_MOUSE_DOUBLECLICK	Determine the type of item that the cursor is currently on and launch the appropriate action when the mouse button is double-clicked.
G\$_NAVIGATION_FRAME	Package containing all of the logic for establishing and executing the options in the navigation frame.
G\$_NCHK	Function which performs a null value check on a passed value.
G\$_NVA_SET_BUTTON	Determines the button color.
G\$_NVA_SET_CANVAS	Determines the canvas color.
G\$_NVA_SET_ITEM	Determines the item color.
G\$_NVA_SET_KEY_BLOCK	Determines the key block color.
G\$_NVA_SET_PROMPT	Determines the prompt color.

Name	Function
G\$_NVA_SET_PROMPT_CODE	Determines the prompt code color and style.
G\$_NVA_SET_RECORD	Determines the highlighted record color.
G\$_NVA_SET_SCROLLBAR	Determines the scrollbar color.
G\$_NVA_SET_SEPARATOR_LINE	Determines the separator color.
G\$_NVA_SET_WINDOW	Determines the window color.
G\$_POPULATE_ATVGIFT_LOVD	Populates the dynamic/run time version of the Record Group.
G\$_POPULATE_ETHNICITY_LIST	Populates the list of ethnicity codes.
G\$_POPULATE_FTVACCI_LOVD	Populates the dynamic/run time version of the Record Group.
G\$_POPULATE_FTVACCT_LOVD	Populates the dynamic/run time version of the Record Group.
G\$_POPULATE_FTVACTV_LOVD	Populates the dynamic/run time version of the Record Group.
G\$_POPULATE_FTVATYP_LOVD	Populates the dynamic/run time version of the Record Group.
G\$_POPULATE_FTVCOAS_LOVD	Populates the dynamic/run time version of the Record Group.
G\$_POPULATE_FTVCTYP_LOVD	Populates the dynamic/run time version of the Record Group.
G\$_POPULATE_FTVFUND_LOVD	Populates the dynamic/run time version of the Record Group.
G\$_POPULATE_FTVLOCN_LOVD	Populates the dynamic/run time version of the Record Group.
G\$_POPULATE_FTVORGN_LOVD	Populates the dynamic/run time version of the Record Group.
G\$_POPULATE_FTVPROG_LOVD	Populates the dynamic/run time version of the Record Group.
G\$_POPULATE_FTVPROJ_LOVD	Populates the dynamic/run time version of the Record Group.

Name	Function
G\$_POPULATE_FTVRUCI_LOVD	Populates the dynamic/run time version of the Record Group.
G\$_POPULATE_GXRDIRD_LOVD	Populates the dynamic/run time version of the Record Group.
G\$_POPULATE_GXVBANK_LOVD	Populates the dynamic/run time version of the Record Group.
G\$_POPULATE_ROIAIDY_LOVD	Populates the dynamic/run time version of the Record Group.
G\$_POPULATE_TBBDETC_LOVD	Populates the dynamic/run time version of the Record Group.
G\$_POP_UP_MENU	Populates and clears popup menus.
G\$_QUERY_ONLY_ROLE	Determines if the current form is running in query-only mode.
G\$_QUICKFLOW	Launches and executes a QuickFlow
G\$_READ_METADATA	Retrieves metadata for the current form.
G\$_RECONNECT	Reestablishes database connection if possible.
G\$_RESET_GLOBAL	Resets the global variables for pop-up windows.
G\$_RESET_VIEW	Resets the position for pop-up windows.
G\$_RESIZE_WEB_WINDOW	Resizes browser windows that are too small.
G\$_RESYNCH_RECORD	Calculates and resynchronizes a block's activity date to prevent date-related errors with APIs.
G\$_SEARCH	Package used with the new code/description search mechanism.
G\$_SEARCH_WHERE	Package used with the new code/description search mechanism.
G\$_SECURED_FORM_CALL	Performs secured form calls.
G\$_SECURED_FORM_CALL_PL	Performs secured form calls.

Name	Function
G\$_SEL_SOBSEQN_MAXSEQNO	Returns the current sequence number in table SOQSEQN for the <code>sobseqn_function</code> argument.
G\$_SEL_SPRIDEN_ID	Returns the current ID for the PIDM argument passed when invoked.
G\$_SEL_SPRIDEN_ID_NAME	Replaced by G\$_VALID_ID.
G\$_SEL_SPRIDEN_PIDM_NAME	Replaced by G\$_VALID_ID.
G\$_SETITEM	Disables or enables an item when passed a valid item name.
G\$_SETMENU	Disables or enables an menu item.
G\$_SET_INST_PROPERTY	Displays the instance name in window title bar.
G\$_SET_USER_PREFERENCES	Stores user preference values.
G\$_SET_WIN_PROPERTY	This procedure is now null.
G\$_SHOW_MENU	This procedure is now null.
G\$_SHOW_MENU_BKSHLF	Displays bookshelf when called from menu item.
G\$_STARTUP	Start-up trigger for validation form.
G\$_TIMER_EXP	Handles the options timer and the bubble help timer.
G\$_TOOLBAR	Executes the appropriate task associated with the setting of the toolbar.
G\$_TRACE_PKG	Routine which is used for debugging purposes.
G\$_UPDATE_ACTIVITY_DATE	Updates the activity date column in the table associated with the current block.
G\$_VALIDATE_FIXED_LENGTH	Checks the length of fixed-length data fields.
G\$_VALID_ALL_ID	Validates person and non-person, and checks for <i>deceased</i> and <i>confidential</i> flags.

Name	Function
G\$_VALID_ID	Validates person.
G\$_VERIFY_ID_EXISTS	Checks for the existence of a specific ID.
G\$_VPDI	The main package supporting Virtual Private Database Indicator (VPDI) processing.
G\$_VPDI_TRIGGER	Executes baseline VPD procedures.
G\$_WALK_FORM	Walks through all items in all blocks of a form.
G\$_WEB_SHOW_DOCUMENT	Creates a web document and displays it in a separate browser window.
G\$_WIN_ACTIVATED	Executes G\$_SET_INST_PROPERTY and G\$_SET_WIN_PROPERTY.
G\$_WIN_CLOSED	Closes the event window.
G\$_WIN_DEACTIVATED	This procedure is now null.
G\$_WRITE_BLOCK	Writes the records from a block to a flat file.

GOQCLIB

To maintain consistency, Banner’s identification forms all reference a Banner library called the Common Forms Object Library (GOQCLIB). This library is a form object, but it is not accessed directly by users. Instead, GOQCLIB is used to store common form elements that are displayed on the General Person Identification Form (SPAIDEN) and many other forms.

The common elements found in GOQCLIB are detailed in Chapter 12, “Basic Person,” of the *Banner General User Guide*.

Workflow Banner Adapter Library (GOQWFLW)

SunGard has delivered Banner forms with a live library called GOQWFLW, the single repository for all baseline, cross-product Banner Workflow functionality available within Banner when it is invoked from Banner Workflow. To guarantee that the required Workflow functionality can be accessed within each form, this library is attached to every baseline Banner form that is defined as a component to Banner Workflow.

Oracle Advanced Queuing

Oracle Advanced Queuing (AQ) is Oracle's message broker implementation that supports asynchronous messaging. AQ is the preferred technology supporting application integration, because it provides database-integrated message queuing.

AQ provides a store and forward capability that guarantees the successful delivery of messages to interested applications. The applications do not need to be running when a Banner Event is created in order to receive the message triggered by the Event.

Banner uses Oracle AQ because it has the flexibility to support any asynchronous communication with systems external to Banner and is a feature that is included with Oracle Enterprise Edition. AQ eliminates the need for a proprietary message broker.

The Banner Event architecture uses Oracle AQ to store Banner Event messages. These are XML messages that describe an event that has occurred in Banner. Interested applications may consume Banner Event messages and act on them.

The Banner Entity API (package `gb_event`) generates event messages when an entity is created, updated, and deleted. In the future, other Banner APIs may also generate Banner Events to indicate that a specific business process has occurred.

AQ is required for LDI (Luminis Data Integration) version 1.1 for e-Procurement, and also for OpenEAI-based integrations. In the future, other SunGard applications may require AQ functionality for integrations with Banner.

AQ support is provided by Banner General 6.2.2, an optional release which supports LDI (Luminis Data Integration) version 1.1 for e-Procurement. Release 7.0 introduces the Banner General objects that support Banner Events, and Release 7.1 includes modifications to several of the general objects in order to support LDI version 1.1 for e-Procurement. Releases 7.0 and 7.1 require Oracle 9.2.0.4. Oracle 9.2.0.5 is required to fully implement Banner Events.

Clients must configure Oracle AQ only if using LDI for e-Procurement version 1.1 messaging integration or any future Banner certified messaging integration.

Note

The `gb_event` package does not contain a hard-coded reference to the Oracle AQ queue names, so this package will compile without errors if AQ is not configured. However, if events are enabled system-wide on the GUAINST form (`gubinst.gubinst_message_enabled_ind`) and enabled for the specific event via the GURMESG form, and Oracle AQ is not configured, a run-time error will occur when attempting to store a Banner Event XML message to Oracle AQ. ■

If you are setting up Oracle AQ, it requires a separate tablespace, which must be named *BANAQ*. This is because of a documented restriction on AQ under Oracle 9i. An Oracle persistent queue's data is stored in a table which is mapped to a tablespace. The tablespace

used to store the Oracle table will not be able to provide tablespace point-in-time recovery. The `gb_advq_util` package will expect a tablespace named *BANAQ* when creating the queues and queue tables.

For more information on setting up Oracle AQ for LDI for e-Procurement, see *Banner AQ Bridge for LDI for e-Procurement 1.1 Installation and Configuration Guide* and *Banner AQ Connection for LDI for e-Procurement 1.1 Configuration Guide*.

Large Object Storage

Release 7.3 introduced centralized Large Object (LOB) storage for Banner applications using a new table, GORBLOB, and a new API, `gb_large_object`. Large Object storage enables users to store files, such as Portable Document Format (PDF) documents, in the database.

This feature will initially be used by Banner Accounts Receivable's eBill functionality, and by the Banner e-Print product. You may use the `gb_large_object` API for other purposes, but those uses are not currently supported by SunGard Higher Education. For institutions interested in building their own secured applications that handle Large Objects, SunGard Higher Education recommends reading *Oracle Application Developer's Guide - Large Objects (LOBs)* prior to working with the `gb_large_object` API and GORBLOB table.

Note

The 7.3 release does not support files being displayed in a RAC (Real Application Clusters) environment from INB. ■

Considerations for Building Custom Applications

Storing Internal LOBs

To use internal LOBs, you must create a separate tablespace for temporary LOB processing. SunGard Higher Education recommends that you make your temporary LOB tablespaces extendable. The General 7.3 installation included creating a Large Object tablespace named BANLOB, with Autoextend *On* by default. If you do not expect to load large objects into the database at this time, you can change the default 1000M allocation for this tablespace to a smaller number.

Storing BFILEs

While SunGard Higher Education supports both internal LOBs and BFILEs, it is strongly recommend that you store your data as internal LOBs. (For the eBill enhancement, you will make this decision when you store the Statement files.) There are many issues with

storing files in the file system that should be understood before choosing the BFILE option.

Choosing Between Internal LOBs and BFILES

Large object data can consume large amounts of disk space. The disk space will be used regardless of whether the LOB data is managed inside the database or outside on the file system. However, internal LOB storage provides many features such as:

- *Transaction recovery*--LOB data is committed and rolled back like any other data.
- *Backup*--LOB data is backed up and restored like any other data in the database.
- *Security*--Security is provided by the baseline Banner security rather than server file system security.
- *Space management*--The LOB data can be managed in a separate tablespace specifically allocated for this purpose.

BFILE storage is an option for clients who require the data to be stored outside the database, but who need to access it from within the database. The interface provided by the `gb_large_object` package makes the physical storage location of the data transparent to the application program.

If you choose to use BFILE storage, carefully consider these issues:

- FILE locators do not participate in database exports. In other words, only the locator is exported, not the data.
- The data in the file system is read-only, so BFILES cannot be updated.
- When an application purges index data from its local table (i.e. TBBSTMT), rather than delete the corresponding GORBLOB row, it will flag that row for later deletion if the data is stored as BFILE. The file system file is *not* deleted. Only the GORBLOB record is flagged as deleted. The purging of the file system files is a system administration task. The system administrator will then have to use a script similar to the following script in order to identify and delete the file system file, and then go back and delete the GORBLOB rows.

```

/*
This is a sample script you might use if you are storing large
objects as BFILES, and the application has flagged the GORBLOB
record for deletion.

Once you run this and obtain the list of files no longer being
referenced by the application, remove them from the file system, and
then delete the gorblob rows.
*/

set serveroutput on
DECLARE
lv_file_name VARCHAR2(100);
BEGIN
  FOR purged_bfiles in (
    SELECT gorblob_media_id
      FROM gorblob
     WHERE gorblob_bfile IS NOT NULL
           AND gorblob_deleted = 'Y') LOOP
    lv_file_name:=
gb_large_object.f_get_bfile_location(purged_bfiles.gorblob_media_id)
;
    dbms_output.put_line( 'rm '||lv_file_name);
  END LOOP;
end;
/

```



4 Upgrade Assistance



Upgrade Modification History/ Maintenance (GUASMOD)

This form was delivered to help you apply Banner releases. It displays script names and descriptions that are associated with a specific release. It is particularly useful for determining the step at which the gostage process failed.

The form is normally used in query-only mode, displaying the status of the modifications. However, you can also use the form to modify the SQL used during the upgrade or to update the modification history table (GURDMOD).

GUASMOD is run outside the Banner menu structure. You must be logged in as `upgrade_owner` with the appropriate password to access this form. You must also have access to the `GUVMODS` view. The view create script is in the file `general/plus/guovmods.sql`.

Warning

Before you modify anything using GUASMOD, be sure you understand the gostage process and know the implications of the changes you are making.

The PC from which you invoke this form must be IBM-compatible with Oracle Forms (Runform) Version 10g and SQL*Net installed.

The path for the Oracle Forms Runform must be able to locate Banner and GUASMOD. The form can be generated by the scripts `general/misc/genform2.bat`, `genformr2.bat`, `genform2.sh1`, or `genformr2.sh1`.

GUASMOD shows the state of the material currently loaded into the `GUBSMOD` and `GURSSQL` tables via the import command done in step 4 of the upgrade guide.

- `GUBSMOD`, the database modification header table, contains one row per modification for the release you are currently applying. It may contain rows from previously releases, if the release is cumulative.
- `GURSSQL`, the database modification SQL repeating row table, contains the SQL commands used to apply the upgrade. It contains one row for each line of text of every database modification script in `GUBSMOD`. There are one or more `GURSSQL` rows for each `GUBSMOD` row.

Stage Modification History

This form displays all the scripts in the database driver and indicates if they have been applied or if they are pending. This is actually from a view, GUVMODS, that does an outer join of the GUBSMOD and GURDMOD tables.

Stage Modification History

Modification	Function	Object	Comment	Status	Owner	Date
E060100.eaag60100	AP	EAA60100	Apply grants for new objects	Applied by	BANIMGR	25-MAY-04
E060100.eabg60100	AP	EAB60100	Apply above BANINST1 script	Applied by	BANINST1	25-MAY-04
E060100.eadb60100	AP	BEADB60100	Apply above generated dbproc script	Applied by	BANINST1	25-MAY-04
E060100.eaobg60100	AP	EAOB60100	Apply above generated script for Baninst1 privs on OTG AE	Applied by	BANINST1	25-MAY-04
E060100.eaps60100	AP	EAPS60100	Apply above generated private synonym for Baninst1 on OT	Applied by	BANINST1	25-MAY-04
E060100.easa60100	AP	EASA60100	Apply synonyms first pass	Applied by	BANINST1	25-MAY-04

All these fields are display-only.

Modification	Modification identifier. This will become the key in the Modification History Table (GURDMOD). It must be in the form <i>RELEASE NUMBER.modcode</i> . This field is case-sensitive.
Function	Indicates if a modification is being applied, or if a test is being made to see if a modification was previously made. Valid values are <i>AP</i> , <i>PT</i> , or <i>PC</i> .
Object	Description or Banner object that is affected by the script.
Comment	A description of what the script does.
Status	Indicates if the modification has been installed. Valid values are <i>Applied</i> and <i>Not Applied</i> .
Owner	The Oracle ID that normally owns the object and will apply the modifications.
Date	The date that the modification was successfully applied.

Stage Modification Maintenance Header/Detail

Stage Modification Maintenance

Release: Modification Code: Environment:

Product Sequence: Application Sequence: Function:

Object: Default Owner:

Comment:

Sequence	Statement
1	Rem eaag60100.sql
2	Rem AUDIT TRAIL: 6.1
3	Rem Apply the generated grants for new database objects
4	Rem RAA 09-FEB-2004
5	Rem AUDIT TRAIL END
6	Rem
7	Rem Delete the staging GJBRSLT record

Header

This displays the modification description row from the GUBSMOD table. This is an updateable block, but it should not ever need to be modified.

Release	The code that represents the release number.
Modification Code	The modcode section of the row's unique identifier, <i>RELEASE NUMBER.modcode</i> .
Environment	For future use.
Product Sequence	Represents which product the modification belongs to. The number specifies the order in which the products are loaded. For example, because the General product must be installed before any other upgrades, all the modifications for General have a Product Sequence of <i>1</i> .
Application Sequence	Indicates the line number in the script. Use Insert Record to add a blank row to the script (the sequence numbers will be updated automatically).
Function	Indicates if a modification is being applied, or if a test is being made to see if a modification was previously made. Valid values are <i>AP</i> , <i>PT</i> , or <i>PC</i> .
Object	Description or Banner object being modified by the script.
Default Owner	Banner owner that owns the object. The default owner will run the database modification script.
Comment	Brief description of the modification.

Detail

This displays the contents of the script that you highlighted in the previous window. The rows are from the GURRSQL table which contains the SQL that will be applied to the database.

You can alter the script that will be used to apply the modification. If you have local modifications, use this window to add or delete a step and then apply your local modification.

Sequence	Line number in modification code script.
Statement	Text of the line in modification code script

Stage Modification History Details Window

The GURDMOD records, if any exist, show when each modification was applied and the corresponding product owners.

You can make changes to the data in this block. It serves two purposes:

1. You can delete the records that shows that the modification was applied. This does not undo the modification. If you cannot rerun the modification or it was never applied to this instance, removing this record will cause gostage to fail. If you delete the record, the modification will be executed again.
2. You can create a modification history record for a modification that was applied to the instance but not properly recorded in the GURMOD table. It will not cause any step to be executed. You must construct the record carefully, based on information in the GUBSMOD block. The **Code** field must be the release number in upper case, a dot, and the modification code in lower case (e.g., *E060100.eaag60100*). The **Applied By** field must contain the Oracle ID that owns the object. The rest of the fields can be entered using information from the GUBSMOD block.

Stage Modification History/Maintenance

Stage Modification Maintenance

Release: Modification Code: Environment:
 Product Sequence: Application Sequence: Function:
 Object: Default Owner:
 Comment:

Stage Modification History/Maintenance

Stage Modification Details

Code: <input type="text" value="E060100.eaag60100"/>	Modification Date: <input type="text" value="25-MAY-04"/>
Applied By: <input type="text" value="BANIMGR"/>	Object: <input type="text" value="EAAG60100"/>
Description: <input type="text" value="Apply grants for new objects"/>	
Code: <input type="text"/>	Modification Date: <input type="text"/>
Applied By: <input type="text"/>	Object: <input type="text"/>
Description: <input type="text"/>	
Code: <input type="text"/>	Modification Date: <input type="text"/>
Applied By: <input type="text"/>	Object: <input type="text"/>
Description: <input type="text"/>	
Code: <input type="text"/>	Modification Date: <input type="text"/>
Applied By: <input type="text"/>	Object: <input type="text"/>
Description: <input type="text"/>	

Code	Key for the history table. The case-sensitive format is <i>RELEASE NUMBER.modcode</i> .
Modification Date	Date the database modification was applied.
Applied By	Banner owner that applied the modification.
Object	In most cases, the name of the object being modified. For documentation only.
Description	Brief description of the modification.





This chapter discusses the objects outside the General product that are shared with the other Banner products.

Common Tables

Integration

The following is a list of all common tables that are shared by all products within Banner:

Table	Description
PTRTENR	Faculty Member Tenure Status Code Table
SHBCOMI	Committee Information Table
SHBCRMY	Ceremony Information Table
SHRCOMC	Committee Comments Table
SHRCOMM	Committee Information Table
SIBCFTE	Faculty Work load Contract FTE Rule Table
SIBFACD	Faculty Information Table
SLBBLDG	Location/Building Description Table
SLBEVNT	Event Base Table
SLBRDEF	Room Description Table
SLRBCAT	Room Category Definition Table
SLRBCMT	Building Comments Table
SLRBDEF	Building Attributes Definition Table
SLRCMNT	Building/Room Comments Table
SLRCOLC	Room Attributes Collector Table

Table	Description
SLRECMT	Events Comments Table
SLRRASG	Room Assignment Table
SLRRDEF	Room Attributes Definition Table
SLRRUSE	Room Usage Restriction Table
SOBSBGI	Source/Background Institution Base Table
SOBSEQN	Sequence Number Base Table
SORBACD	Source/Background Institution Academic Repeating Table
SORBCHR	Source/Background Institution Characteristics Repeating Table
SORBCMT	Source/Background Institution Comments Repeating Table
SORBCNT	Source/Background Institution Contact Person Repeating Table
SORBDEG	Source/Background Institution Degrees Offered Repeating Table
SORBDMO	Source/Background Institution Demographics Repeating Table
SORBDDL	Source/Background Institution Diplomas Offered Repeating Table
SORBETH	Source/Background Institution Ethnic Make-up Repeating Table
SORBTST	Source/Background Institution Test Score Repeating Table
SORCONC	Prior College Concentration Area Repeating Table
SORDEGR	Prior College Degree Table
SORFADR	Fin. Aid Data Reconciliation Table
SORGEOR	Geographic Region Rules Table
SORMAJR	Prior College Major Repeating Table
SORMINR	Prior College Minor Repeating Table
SORPCOL	Prior College Table
SPBPERS	Basic Person Base Table
SPRADDR	Address Repeating Table
SPRCOLR	Person Collector Table

Table	Description
SPREMRG	Emergency Contact Repeating Table
SPRHOLD	Person Related Holds Repeating Table
SPRIDEN	Person Identification/Name Repeating Table
SPRTELE	Telephone Table
SSBSECT	Section General Information Base Table
SSRMEET	Section Meeting Times Repeating Table
SSRXLST	Cross List Section Repeating Table
STVACAT	Award Category Validation Table
STVACCG	Activity Category Validation Table
STVACTC	Student Activity Validation Table
STVACTP	Activity Type Validation Table
STVACYR	Academic Year Validation Table
STVADMR	Admission Request Code Validation Table
STVASCD	Room Assignment Status Code Validation Table
STVASRC	Address Source Code Validation Table
STVASTY	Assignment Type Validation Table
STVATYP	Address Type Validation Table
STVBCHR	Background Institution Characteristics Validation Table
STVBLDG	Building Code Validation Table
STVCAMP	Campus Validation Table
STVCIPC	CIP Code Validation Table
STVCITZ	Citizen Type Validation Table
STVCNTY	County Code Validation Table
STVCOLL	College Validation Table
STVCOMF	Committee Function Code Table

Table	Description
STVCOMS	Committee Status Code Table
STVCOMT	Committee Type Code Table
STVDAYS	Day of Week Validation Table
STVDEGC	Degree Code Validation Table
STVDEPT	Department Validation Table
STVDISA	Disability Type Validation Table
STVDLEV	Faculty Member Degree Level Validation Table
STVDPLM	Diploma Type Validation Table
STVEMPT	Employment Type Validation Table
STVETCT	IPEDS Ethnic Validation Table
STVETHN	Ethnic Code Validation Table
STVETYP	Event Type Validation Table
STVFCNT	Faculty Contract Type Validation Table
STVGEOD	Geographic Region Division Validation Table
STVGEOR	Geographic Region Validation Table
STVHLDD	Person Hold Type Validation Table
STVHOND	Degree Honors Validation Code Table
STVHONR	Academic History Departmental Honors Validation Table
STVINIT	Recruiting Initials Code Validation Table
STVLANG	Native Language Validation Table
STVLEAD	Leadership Validation Table
STVLEVL	Student Level Validation Table
STVLGCY	Legacy Code Validation Table
STVMAJR	Major, Minor, Concentration Validation Table
STVMATL	Recruiting Material Code Validation Table

Table	Description
STVMDEQ	Medical Equipment Code Validation Table
STVMEDI	Medical Code Validation Table
STVMRTL	Marital Status Validation Table
STVNATN	Nation Validation Table
STVORIG	Originator Validation Table
STVPENT	Port of Entry Validation Table
STVPRCD	Phone Rate Code Validation Table
STVPTYP	Person Type Validation Table
STVRDEF	Building/Room Attributes Validation Table
STVRELG	Religion Code Validation Table
STVRELT	Relationship Validation Table
STVRMST	Room Status Code Validation Table
STVRRCD	Room Rate Code Validation Table
STVSBGI	Source/Background Inst Validation Table
STVSITE	Site Validation Table
STVSPON	International Sponsor Validation Table
STVSPSR	Disability Type Validation Table
STVSTAT	State Code Validation Table
STVSUBJ	Subject Validation Table
STVTELE	Telephone Type Validation Table
STVTERM	Term Code Validation Table
STVTESC	Test Score Validation Table
STVTRMT	Term Type Validation Table
STVVTYP	Visa Type Code Validation Table

Common Objects

The following is a list of common objects shared by all products:

Script Name	Object
aofacon.sql	f_alumni_constituent_ind function
aofaorn.sql	f_alumni_organization_ind function
aoffrdn.sql	f_alumni_friend_ind function
comview.sql	driver script to compile all common views
foffagn.sql	f_finance_agency_ind function
foffban.sql	f_finance_bank_ind function
foffcun.sql	f_finance_customer_ind function
foffden.sql	f_get_finance_desc function
foffemn.sql	f_finance_employee_ind function
foffmgn.sql	f_finance_manager_ind function
fofforn.sql	f_get_special_finance_desc function
foffven.sql	f_finance_vendor_ind function
fofusrn.sql	f_finance_user_ind function
pofhapn.sql	f_payroll_applicant_ind function
pofhben.sql	f_payroll_beneficiary_ind function
pofhcbn.sql	f_payroll_cobra_ind function
pofhemn.sql	f_payroll_employee_ind function
popheon.sql	f_get_eeoc_description function
ptrtenr.fmb	Tenure Code Rule Form
rofrapn.sql	f_finaid_applicant_ind function
rofratn.sql	f_fa_amt_term_func function
rofrayn.sql	f_fa_amt_uear_fun function

Script Name	Object
rofrcsn.sql	f_sem_csed_fun function
rofrden.sql	f_finaid_get_desc function
rofrfcn.sql	f_family_contrib_fnc function
rofrfin.sql	f_family_income_fnc function
rofrfan.sql	f_inst_aid_fnc function
rofrpcn.sql	f_parent_contrib_fnc function
rofrpyn.sql	f_authorized_payments function
shacomf.fmb	Committee/Service Form
shicmbq.fmb	Committee/Service Member Inquiry Form
shicmid.fmb	Committee/Service by Person Inquiry Form
shicomq.fmb	Committee/Service Inquiry Form
shvcomi.sql	Committee Query View
shvcomm.sql	Committee Member Query View
slabldg.fmb	Building Definition Form
slabqry.fmb	Building Query Form
slaevnt.fmb	Event Form
slardef.fmb	Room Definition Form
sliaevn.fmb	Event Available Room Query Form
slqbcat.fmb	Building Category Query Form
slqevnt.fmb	Event Query Form
slqroom.fmb	Room Query Form
soacomp.fmb	Non Person Search Form
soaddrq.fmb	Address Summary Form
soageor.fmb	Geographic Region Rules Forms
soahold.fmb	Hold Information Form

Script Name	Object
soaiden.fmb	Person Search Form
soaigeo.fmb	Geographic Regions by ID Form
soaqgeo.fmb	Geographic Region Query Form
soasbgi.fmb	Source/Background Institution Base Form
sofsadn.sql	f_student_admissions_ind function
sofsapn.sql	f_applied_for_degree function
sofscdn.sql	f_get_class_desc function
sofscln.sql	f_class_calc_fnc function
sofsden.sql	f_student_get_desc function
sofseln.sql	f_enrolled_this_term function
sofsern.sql	f_student_enrollment_ind function
sofsfan.sql	f_student_faculty_ind function
sofsgrn.sql	f_graduated_from_institution function
sofsgsn.sql	f_student_gen_students_ind function
sofshcn.sql	f_get_hsch_code function
sofshin.sql	f_high_school_rowid function
sofshon.sql	f_student_housing_ind function
sofsrcn.sql	f_student_recruit_ind function
sofsren.sql	f_student_registration_ind function
sofsrgn.sql	f_registered_this_term function
sofstdn.sql	f_sgbstdn_fields function
sofstrn.sql	f_student_transfer_work_ind function
sofstsn.sql	f_get_sortest_rowid function
sofstun.sql	f_get_sgbstdn_rowid function
soisbgi.fmb	Source/Background Institution Query Only Form

Script Name	Object
soqhold.fmb	Holds Query Only Form
soqmenu.fmb	Student Menu Form
sovcolp.sql	Prior College Information View
sovconc.sql	Prior College Concentration Area Information View
sovdegr.sql	Prior College Degree Information View
sovgeor.sql	Geographic Region View
sovmajr.sql	Prior College Major Information View
sovminr.sql	Prior College Minor Information View
sovsbgr.sql	Source/Background Institution Base Information View
spvaddf.sql	Address Hierarchy View for FOCUS
spvaddi.sql	Addresses for BannerQuest View
spvaddr.sql	Address Hierarchy Selection View
spvadds.sql	Address Hierarchy View
spvcurr.sql	Current PIDM, ID, and Name Information View
spvintl.sql	Person International Information View
spvmedi.sql	Person Medical Information View
ssamatx.fmb	Building/Room Schedule Form
ssvmeet.sql	Section Meeting Time View
stkcomf.sql	Cursor stvcomfc
stkcoms.sql	Cursor stvcomsc
stkcomt.sql	Cursor stvcomtc
stkhond.sql	Cursor stvhond
stvacat.fmb	Degree Award Category Code Validation Form
stvaccg.fmb	Activity Category Validation Form
stvactc.fmb	Activity Code Validation Form

Script Name	Object
stvactp.fmb	Activity Type Validation Form
stvacyr.fmb	Academic Year Validation Form
stvadmr.fmb	Admission Request Checklist Code Validation Form
stvascd.fmb	Room Assignment Status Code Validation Form
stvasrc.fmb	Address Source Validation Form
stvasty.fmb	Assignment Type Code Validation Form
stvatyp.fmb	Address Type Code Validation Form
stvbchr.fmb	Background Inst. Characteristic Code Validation Form
stvbldg.fmb	Building Code Validation Form
stvcamp.fmb	Campus Code Validation Form
stvcipc.fmb	CIPC Code Validation Form
stvcitz.fmb	Citizen Type Code Validation Form
stvcnty.fmb	County Code Validation Form
stvcoll.fmb	College Code Validation Form
stvcomf.fmb	Committee Member Role/Function Validation Form
stvcoms.fmb	Committee/Service Status Validation Form
stvcomt.fmb	Committee/Service Type Code Validation Form
stvdays.fmb	Days of the Week Validation Form
stvdegc.fmb	Degree Code Validation Form
stvdept.fmb	Department Code Validation Form
stvdisa.fmb	Disability Type Code Validation Form
stvdlv.fmb	Degree Level Code Validation Form
stvdplm.fmb	Diploma Type Code Validation Form
stvempt.fmb	Employment Type Validation Form
stvetct.fmb	IPEDS Ethic Code Validation Form

Script Name	Object
stvethn.fmb	Ethnic Code Validation Form
stvetyp.fmb	Event/Function Type Code Validation Form
stvfcnt.fmb	Faculty Contract Code Validation Form
stvgeod.fmb	Geographic Region Division Code Validation Form
stvgeor.fmb	Geographic Region Code Validation Form
stvhldd.fmb	Hold Type Code Validation Form
stvhond.fmb	Departmental Honors COde Validation Form
stvhonr.fmb	Institutional Honors Code Validation Form
stvinit.fmb	Initials Code Validation Form
stvlang.fmb	Language Code Validation Form
stvlead.fmb	Leadership Validation Form
stvlgcy.fmb	Legacy Code Validation Form
stvmajr.fmb	Major, Minor, Concentration Code Validation Form
stvmatl.fmb	Material Code Validation Form
stvmdeq.fmb	Medical Equipment Code Validation Form
stvmedi.fmb	Medical Code Validation Form
stvmrtl.fmb	Marital Status Code Validation Form
stvnatn.fmb	Nation Code Validation Form
stvorig.fmb	Originator Code Validation Form
stvpent.fmb	Port of Entry Code Validation Form
stvprcd.fmb	Phone Rate Code Validation Form
stvptyp.fmb	Source Contract Person Type Code Validation Form
stvrdef.fmb	Building/Room Attribute Code Validation Form
stvrelg.fmb	Religion Code Validation Form
stvrelt.fmb	Relation Code Validation Form

Script Name	Object
stvrnst.fmb	Room Status Code Validation Form
stvrncd.fmb	Room Rate Code Validation Form
stvsbgj.fmb	Source/Background Institution Code Validation Form
stvsite.fmb	Site Code Validation Form
stvspon.fmb	International Student Sponsor Code Validation Form
stvspr.fmb	Disability Service Code Validation Form
stvstat.fmb	State/Province Code Validation Form
stvsubj.fmb	Subject Code Validation Form
stvtele.fmb	Telephone Type Validation Code Form
stvterm.fmb	Term Code Validation Form
stvtesc.fmb	Test Code Validation Form
stvtrmt.fmb	Term Type Validation Form
stvtyp.fmb	Visa Type Code Validation Form
toftadn.sql	f_amount_due function
toftbln.sql	f_account_balance function
toftccn.sql	f_calc_and_call_fnc function
toftchn.sql	f_term_charges function
toftcon.sql	f_collection_ind function
toftcrn.sql	f_cat_range_fnc function
toftctn.sql	f_cat_term_fnc function
toftdan.sql	f_calc_aged_days function
toftden.sql	f_get_ar_desc function
toftdon.sql	f_ar_deposit_ind function
toftdpn.sql	f_deposit_balance function
toftdtn.sql	f_ar_detail_ind function

Script Name	Object
toftfn.sql	f_oldest_effective_date function
toffan.sql	f_financial_aid_memos function
tofthrn.sql	f_other_range_fnc function
tofthtn.sql	f_other_term_fnc function
toftmen.sql	f_memo_balance function
toftmmn.sql	f_ar_memo_ind function
toftomn.sql	f_opt_term_fnc function
toftorn.sql	f_opt_range_fnc function
toftotn.sql	f_balance_other_terms function
toftown.sql	f_amount_owned function
toftpan.sql	f_term_payments function
toftpf.sql	f_ar_profile_ind function
toftrrn.sql	f_req_range_fnc function
toftrtn.sql	f_req_term_fnc function
toftsln.sql	f_calc_aging_slot function

Ethnicity Codes in Banner

This section gives you a guide for building and maintaining the tables that store ethnicity data. You should consider these factors when preparing ethnicity data entry for EEO reporting within the Human Resources system and for IPEDS reporting within the Student system.

Ethnic Distinctions

The Ethnic Codes Rule Form (PTRETHN) and IPEDS Ethnic Validation Table (STVETCT) store information about the ethnic background of individuals.

Note

Institutions can use the IPEDS Ethnic Validation Table to record Federal Government reporting codes. Values not used for official reporting should not be added to STVETCT. ■

If you need to store more distinctive, perhaps institution-specific, ethnicity descriptions, use the Ethnic Code Validation Table (STVETHN). This table allows you to make further ethnicity distinctions, such as entering Apache, Blackfoot, and Sioux as types of Native American. These lower value codes are then crosswalked into the Human Resources and Student systems against the PTRETHN and the STVETCT forms respectively. This crosswalk mapping ensures proper Federal ethnic values.

Note

Be sure to coordinate the process of maintaining the Ethnic Code Validation Table (STVETHN) between the Student and Human Resources systems, so that you use agreed upon values where appropriate. Once you enter values, under no circumstances should you change or delete them to coincide with reports. ■

New Race and Ethnicity Categories

The U.S. 2000 Census was collected using new race and ethnicity categories, and the EEOC has mandated that Affirmation Action reports for 2005 use this census data for comparison purposes. Not all U.S. government departments have adopted this requirement. SunGard anticipates that the National Center for Education Statistics (NCES) will eventually release new IPEDS reporting parameters that require institutions to provide information based on the new OMB categories. Thus, institutions should begin the process of collecting the information based on the new categories.

Banner is being updated to collect data based on the new race and ethnicity categories. In addition to the new categories, a person now has the ability to select one or more of the race categories. Currently, Banner only allows one ethnicity per person record on SPBPERS.

Banner's current **Ethnicity Code** will continue to be maintained by Banner on the appropriate person forms. In order to comply with the EEOC, SunGard will release new rules and Human Resources forms to comply with the data collection requirements.

New Race Code Forms

The Regulatory Race Validation (GTVRRAC) table stores regulatory race codes. U.S. government codes were delivered as *system required* seed data in General Release 7.2. This table is maintained on the Regulatory Race Validation Form (GTVRRAC)

Note

These new codes will not be used for the 2005 IPEDS reporting cycle. However, they must be mapped to race codes (see below) for future regulatory reporting. ■

Institution-defined race codes can be established on the new Race Rules Form (GORRACE) and are stored on the Race Rules (GORRACE) table. When creating these codes, there should be at least one race code for each of the U.S. government-established regulatory race codes (as mentioned above).

For more information on the forms and tables for the new race codes, refer to the *Banner General User Guide*.

A **New Ethnicity Code** has been added to the Ethnic Code Validation Form (STVETHN). The old **Ethnicity Code** field will continue to be maintained.

The new race and ethnicity fields will appear on the Biographical window when the specific Banner product's forms are redelivered. This will occur after Release 7.2 of Banner General.

More information on working with the new ethnicity and race codes will be included in the documentation for upcoming releases of the Banner Human Resources system.

Nonresident Aliens

When dealing with individuals who are nonresident aliens, it is important to be aware of the methods for reporting them in the Student and Human Resources systems.

Student System

The Student System's IPEDS report will not consider an individual's ethnic code if the person is a nonresident alien. An individual achieves nonresident alien status in the Student system if the current visa type established on the International Information Form (GOAINTL) for that person has been set up on the Visa Type Code Validation Form (STVVVYP) with the Non-Res(ident Alien Indicator) check box selected.

Human Resources System

The Human Resources system will not report an individual's ethnic code if that person is a nonresident alien. An individual achieves nonresident alien status in the Human Resources system if both of the following are true at the same time:

- the Citizen code is entered on the Identification Form (PPAIDEN) with a corresponding entry in the Citizen Type Validation Table (STVCITZ) and the citizen indicator STVCITZ_CITIZEN_IND set to *N*.
- the person exists in the Person International Information Table (GOBINTL) and the Alien Registration Number field GOBINTL_ALIEN_REG_NUMBER is null (has no value).

The Human Resources system will report a person's ethnic code if all of the above hold true except the person's Alien Registration Number is not null (has a value).



Enhanced Oracle*Reports

Note

The infrastructure of Oracle*Reports has changed significantly between Reports 6i and Reports 10g. Please refer to the Banner 7.0 FAQ for known issues with Oracle*Reports and Banner. ■

For Release 7.0, both the mechanism that creates Oracle*Reports in Banner and the delivered reports have been changed:

- You can now run lengthy reports in asynchronous mode, so you can return to working with Banner forms while your report is running.
- If you want, you can review your parameters on the Oracle Report Value Window and make changes before submitting the job.
- You can send the output of a report to an e-mail address.
- You can run *all* delivered reports from either the calling forms or from the Process Submission Controls Form (GJAPCTL).

The format of the reports and the information they provide has not changed.

Banner 7.0 requires Oracle*Reports 10g and uses the Oracle*Developer Suite toolset. Objects were migrated to the Oracle*Developer Suite 10g toolset, and now use the `RUN_REPORT_OBJECT` built-in. You can specify:

- The format of the report (PDF, HTML, RTF, XML, etc.)
- The destination type of the report (CACHE, FILE, MAIL, or PRINTER)
- Where you want the report to be sent (either a file location or, if the destination type is MAIL, an e-mail address)
- The execution mode (BATCH or RUNTIME)
- Whether the report should be run synchronously or asynchronously
- Whether you will run the report from GJAPCTL alone or from the form that is specifically used to run the report
- Whether the Oracle Reports parameter form should appear, displaying the existing parameters and allowing you to change them

In addition, when you submit a report asynchronously now, you will receive a message in a pop-up window with the report job ID.

The delivered Oracle reports for A/R, Finance and Student, have been changed to work with Oracle*Reports 10g. For details about each report, please refer to the product-specific release guides.

To use Oracle*Reports 10g, you must have your report objects running on a report service that is running on a report server.

In a previous release, an entry was added to the General User Preferences Maintenance Form (GUAUPRF) to allow you to enter the Oracle Reports Server. A row was added to the Personal Preference Table (GURUPRF) to store this value. Neither of these have been changed for Release 7.0.

New for Release 7.0 is an entry added to the General User Preferences Maintenance Form (GUAUPRF) to allow you to enter the Oracle Reports Service. A row is added to the Personal Preference Table (GURUPRF) to store this value.

Enhanced Security for Oracle*Reports

Release 7.1 introduced several security enhancements for Oracle*Reports. The security enhancements were implemented through:

- Changes to the General PL/SQL Oracle*Reports Library (goqorep.pll) and the Report Forms Object Library (goqrlib.fmb). See “General PL/SQL Oracle*Reports Library (GOQOREP),” later in this chapter, for details.
- Changes to forms that call Oracle Reports. See “7.1 Changes for Forms that Call Oracle Reports,” later in this chapter, for details.
- Changes to Oracle Reports RDF files. See “7.1 Changes for Oracle Reports RDF Files,” later in this chapter, for details.

In addition, two new JAR files were introduced:

- `banorep.jar`, used to control cookie time-out and other settings for Oracle Reports security.
- `bannerid.jar`, used to access the SEED numbers for Oracle Reports security.

Only DBAs and/or site administrators can change the contents of these two JAR files. The *Middle Tier Implementation Guide* details the setup of these files.

With Release 7.1, it is no longer necessary to generate a checksum for Oracle Reports. The Checksum Generator Program (`gurchks.exe`) is no longer used. Instead, SEED numbers for Oracle Reports security are handled by the new `bannerid.jar` file.

Setting Up Banner to Run the Enhanced Oracle* Reports

1. Log on as the Baseline user.
2. Access the General User Preferences Maintenance Form (GUAUPRF) and select the Directory Options tab.
3. Scroll down until you see the *Enter the name of your Oracle Reports server* entry. (This entry is not new for Release 7.0.)
4. If the information is not already there, enter the name of your Oracle Reports server, which is:
 - 4.1. Your environment's machine name
 - 4.2. The port value

For example: `http://machname:7778/reports/rwservlet?`
5. The next entry is the *Enter the name of your Oracle Reports Service Name* entry. (It is new for Release 7.0.)
6. Enter the location of your Oracle Reports Service.

For example: `rep_machname`
7. Save your changes.

Setting Up Default Values for Parameters 71-77

Job Submission parameters 71 -77 define how the report will be run (e.g., its format, destination, whether it will be run in synchronous or asynchronous mode, etc.). You can set up the default values for each report on the Parameter Definitions Form (GJAPDEF) and the Parameter Value Validations Form (GJAPVAL).

1. Access the Parameter Definitions Form (GJAPDEF).
2. Enter a value for 71 - Destination Format.

Define the report's default format. Valid values include *DELIMITED*, *HTML*, *PDF*, and *RTF*. The default value is *PDF*.

Note

POSTSCRIPT and *PRINTER DEFINITION* are not available at this time. If you choose either of them, you will receive the error *Destination format of printer definition is not currently supported*. ■

3. Enter a value for 72 - Destination Type.

Specify the report's default destination type. Valid values are:

- *CACHE* - display the report on the screen (the default)
- *FILE* - save the report to a file
- *MAIL* - send the report to an e-mail address
- *PRINTER* - send the report to a printer

When you choose a **Destination Type** of *Cache*, the Parameter Form is automatically populated with an **Execution Mode** of *Runtime*, a **Communication Mode** of *Synchronous*, and a **Parameter Form** value of *Yes* by default.

When you choose a **Destination Type** of *File*, *Printer*, or *Mail*, the Parameter Form is automatically populated with an **Execution Mode** of *Batch*, a **Communication Mode** of *Asynchronous*, and a **Parameter Form** value of *No* by default.

 **Note**

Because your institution's reports could contain sensitive information, make sure that you send report data to a place where only the appropriate users have access to it. ■

4. Enter a value for 73 - Destination Name.

Define the default location where you want the report to be sent. You can enter up to 30 characters.

- If the Destination Type is *FILE*, this must be the name and location of a file to which the data should be written.
- If the Destination Type is *MAIL*, this must be a valid e-mail address. If you are sending the data to more than one address, each address must be separated by a comma (no spaces are permitted).
- If the Destination Type is *PRINTER*, this must be a valid printer name. If you leave this blank, the output will go to the report server's default printer (if you have defined one).
- If the Destination Type is *CACHE*, you do not need to (and will not be allowed to) enter a destination name.

5. Enter a value for 74 - Execution Mode.

Specify either *BATCH* or *RUNTIME* as the execution mode. *RUNTIME* is the default value.

6. Enter a value for 75 - Communication Mode.

- If the Communication Mode is *ASYN*C (asynchronous), the person who submitted the report can continue working in Banner while the report runs.

- If the Communication Mode is *SYNC* (synchronous), control only returns to the calling form after the report has finished processing.

The default value is *SYNC*.

 **Note**

If parameter 75 is *ASync*, parameter 76, Parameter Form Designation, cannot be *YES*. ■

7. Enter a value for 76 - Parameter Form Designation, if you wish.

Controls the display of the Oracle Reports parameter form:

- If *YES*, the form is displayed.
- If *NO*, the form is not displayed.

 **Note**

If parameter 76 is *YES*, then parameter 72, Destination Type, must be *CACHE*. ■

 **Note**

Parameter 76 cannot be *YES* if parameter 75, Communication Mode, is *ASync*. ■

 **Note**

As of Release 7.1, there was a known issue related to Oracle Reports when parameter 76 is *YES* and any other parameter has a wildcard value. If you run a report with that combination, you will receive an error. ■

8. Enter a value for 77 - Show Report Value Window.

Specify if the Oracle Report Value Window should appear when a user runs a report from a form other than GJAPCTL.

- If *YES*, the window will appear and the user can change the values before submitting the report.
- If *NO*, the window does not appear and the report is run with Parameter Definition values. If no Parameter Definition values were set up for the report, default values will be used.

 **Note**

It is not necessary for the Report Value Window to be displayed for reports run from GJAPCTL because the information it contains is displayed in the Parameter Values block on GJAPCTL. Essentially, Parameter 77 has no meaning to GJAPCTL. ■

9. Save your changes.

Running Custom Oracle Reports with Default Parameters

Parameters 71 through 76 have been set up for all BASELINE Oracle Reports. Typically, you will set up these parameters for each custom Oracle Report (specifically, for each RDF). If you run a custom report without first setting up parameters, default values will be used for parameters 71 through 76.

The default values are set temporarily for the report in GJAPCTL when you perform a next block function from the key block. This logic is in place to minimally support the required parameters 71 through 76, until those GJPDEF rows can be set for the report.

User Preferences for Oracle Reports Output

The file name format and location of Oracle Reports can be controlled through settings in the General User Preference Maintenance Form (GUAUPRF).

A record in the Directory Options tab allows you to control the file name format and location of Oracle Reports output. With this record, you can control where users send their report output when the report **Destination Type** is set to *File* (DESTYPE=FILE).

If you change nothing on the BASELINE row (i.e., where GURUPRF_USER_ID is equal to BASELINE), then the value *DEFAULT_BEHAVIOR* is used, and users send their output to the drive/folder/subfolder specified in the Destination Name field or to the default directory on the Reports server, if Destination Name is valued with only a file name. This is the same way this feature worked in previous releases. However, you have the option to enter the name of an Oracle Reports root-level folder/subfolder value (including an ending slash).

To this root-level folder/subfolder value, you have the option to append:

- An indication for including a timestamp in the report file name (*date*)
- An indication for having the report file written to an oracle-username-subfolder (*user*)
- Indications for both timestamp and username subfolder (*user,date*)

If your institution chooses not to append the string date to the report file name, then you must otherwise ensure that duplicate file names are not overwritten.

If you use any of the new options, keep in mind that the methods you use to periodically purge the output on your Reports server may need to be adjusted. Also, when running the reports, users will enter just the file name (and extension) in the **Destination Name** field. The configured options will be dynamically constructed into this entered **Destination Name** value.

The delivered value for BASELINE is *DEFAULT_BEHAVIOR*. You may change this value to one of the following options:

- A root-level folder (including an ending slash) to which all Oracle Reports output with a **Destination Type** of *File* will be sent. This root-level folder must exist and be writable by the Reports server.

Example of the BASELINE row configuration

Windows:

f:\orep_root\

Unix/Linux:

/u02/orep_root/

Example of what output might look like with this BASELINE row configuration

Windows:

f:\orep_root\sample_report.pdf

Unix/Linux:

/u02/orep_root/sample_report.pdf

If you choose this option, make sure that all Oracle Reports users are configured to access files at this root location, and that the Windows share (or Unix security) is configured accordingly. Users need read access to this folder. Additionally, make sure that they do not send report output with sensitive data to this folder.

If a value exists in the **User Value** field for this corresponding type of BASELINE row, it will be ignored.

- A root-level folder and the string *user* . If desired, users may specify subfolders within their username folder by entering the name of the subfolder in the corresponding **User Value** field of GUAUPRF (including an ending slash). This specified subfolder must exist.

Example of the BASELINE row configuration

Windows:

f:\orep_root\user

Unix/Linux:

/u02/orep_root/user

Example of what output might look like with this BASELINE row configuration

Windows:

f:\orep_root\jdoe\sample_report.pdf

Unix/Linux:

/u02/orep_root/jdoesample_report.pdf

Example of what output might look like if a User Value subfolder of xyz\ (for Windows) or xyz/ (for Unix) is specified on the users GUAUPRF row

Windows:

f:\orep_root\jdoe\xyz\sample_report.pdf

Unix/Linux:
/u02/orep_root/jdoe/xyz/sample_report.pdf

 **Note**

You must create user folders for Oracle user IDs, if you choose this option. If you do not, the Reports server will not be able to write the file to the specified location. It is recommended that you create Windows share (or Unix security) on these user folders. ■

- A root-level folder and the string *date*. If you choose this option, then a unique time stamp will be appended to the end of the report name, so that files will not be overwritten.

Example of the BASELINE row configuration

Windows:
f:\orep_root\date

Unix/Linux:
/u02/orep_root/date

Example of what output might look like with this BASELINE row configuration

Windows:f:\orep_root\sample_report20061212081255.pdf

Unix/Linux:
/u02/orep_root/sample_report20061212081255.pdf

- A root-level folder and the strings *user,date*.

Example of the BASELINE row configuration

Windows:
f:\orep_root\user,date

Unix/Linux:
/u02/orep_root/user,date

Example of what output might look like with this BASELINE row configuration

Windows:f:\orep_root\jdoe\sample_report20061212081255.pdf

Unix/Linux:
/u02/orep_root/jdoe/sample_report20061212081255.pdf

 **Note**

You must create user folders for Oracle user IDs if you choose this option. If you do not, the Reports server will not be able to write the file to the specified location. It is recommended that you create Windows share (or Unix security) on these user folders. ■

Changes to Support Enhanced Oracle Reports

The following changes were introduced with Release 7.0 to support enhanced Oracle Reports with Reports 10g. Please refer to the *Banner General User Guide* for details on these changes.

- The Job Submission Profile Maintenance Form (GJAJPRF) was not made obsolete for Release 7.0, but the functionality it had performed is no longer necessary.
- Extensive changes were made to the Process Submission Controls Form (GJAPCTL) to allow more flexibility in running both delivered reports and custom reports.
- A new entry has been added to the General User Preferences Maintenance Form (GUAUPRF) to hold the location of the Oracle Reports Service Name.

Student, Finance, and Accounts Receivable Reports

All of the Oracle Reports delivered for A/R, Finance, and Student were migrated to the new Oracle*Developer Suite 10g (Oracle Reports 10g). Please refer to the product-specific documentation for a list of those reports.

Each of the Banner 6.x BASELINE Oracle*Report source files was converted via the Oracle*Developer Suite Reports 10g Builder toolset. They were then changed to use the new RUN_REPORT_OBJECT built-in so the Oracle Report Value Window will include the new parameters from GJAPCTL.

Three new parameters were added:

Parameter	Datatype	Size	Initial Value
P_ACTION	Character	200	_action_
P_SERVERNAME	Character	40	None
P_USER_CONNECT	Character	200	None

Also, the function BEFOREPFORM was changed to facilitate connections and communications with the report server. The following is an example of the changed function, and the new lines are marked *NEW*.

```

Function BeforePForm return boolean is
--
NEW  vc_parameter_form          varchar2(4000);
NEW  vc_hidden_runtime_values  varchar2(1000);
NEW  vc_report_name            varchar2(100);
NEW  hold_cmd VARCHAR2(240);
begin
  if :P_Pass = 'INSECURED' then
    return (TRUE);
  end if;
  --
  if :P_Role IS NOT NULL then
    if substr(:P_Pass,1,1) = chr(34) then
      Hold_Cmd := :P_Role||' IDENTIFIED BY '||:P_Pass;
    else
      Hold_Cmd := :P_Role||' IDENTIFIED BY '||chr(34)||:P_Pass ||chr(34);
    end if;
    DBMS_SESSION.SET_ROLE(Hold_Cmd);
  end if;
  IF :parm03 is null then
    :parm03 := 'M' ;
  end if;
  NEW If (:p_action='_action_') then
  NEW  vc_hidden_runtime_values:='_hidden_';
  NEW else
  NEW  srw.get_report_name(vc_report_name);
  NEW  vc_hidden_runtime_values:='report='||vc_report_name||'&destype='
  NEW  ||:destype||'&desformat='||:desformat||'&userid='
  NEW  ||:p_user_connect||'&server='||:p_servername;
  NEW end if;
  NEW vc_parameter_form:='<html><body bgcolor="#ffffff"><form method=post action=""
  NEW ||:P_ACTION||'">'||'<input name="hidden_run_parameters" type=hidden value=""
  NEW ||vc_hidden_runtime_values||'">'||'<center><p><table border=0 cellpadding=0
  NEW ||'<input type=submit></td><td width=15><td><input type=reset></td>'||'</tr></
  NEW ||'<p><hr><p>';
  --
  NEW srw.set_before_form_html (srw.text_escape, vc_parameter_form);
  return (TRUE);

```

```

--
exception
  when others then
    SRW.MESSAGE(1000, '*ERROR* Before Parm trigger could not set database role -
report terminated. ');
    return (FALSE);
end;

```

Parameters 71-77

Beginning with Release 7.0, the following new parameters are available for all reports:

- 71 - Destination Format
- 72 - Destination Type
- 73 - Destination Name
- 74 - Execution Mode
- 75 - Communication Mode
- 76 - Parameter Form
- 77 - Display Report Value Window

See “Setting Up Default Values for Parameters 71-77,” earlier in this chapter, for more information on these parameters.

7.1 Changes for Forms that Call Oracle Reports

With Release 7.1, all BASELINE forms that call Oracle Reports had specific changes made to them. You will need to apply these changes to any custom forms that call Oracle Reports.

Note

Make these changes only after you have completed all 7.0 changes. ■

Description of Changes

Before opening the equivalent to the BASELINE 7.0 version of the FMB file for modification, be sure that your FORMS90_PATH can see the 7.1 version of goqorep.pll and goqrlib.fmb.

1. Open the equivalent to the BASELINE 7.0 version of the .fmb file for modification using Forms*Builder10g. This will pull in reference modifications from the 7.1 version of goqrlib.fmb for items G\$_BANNER_REPORT_HEADER.REPORT_BEAN and G\$_BANNER_REPORT_HEADER.LIST_PARAM_NAMES.
2. Set CANVAS of the REPORT_BEAN to the canvas of the KEY_BLOCK. If the form does not have a KEY_BLOCK, set the CANVAS of the REPORT_BEAN to that of the canvas of the first navigable block.item in the form. This ensures that the REPORT_BEAN item becomes properly initialized when the form is first run.
3. If this form does pass report parameter values, modify the trigger that calls the report (REPORT_269 is an example of a trigger that passes report parameters from the Finance product) to value the item LIST_PARAM_NAMES with a string of parm names (each separated by '::') that are used by the report. The following is an example of this trigger, with <---ADD LINE indicating the coding modification:

```
DECLARE
lv_list_id          PARAMLIST;
BEGIN
if :system.record_status in ('NEW', 'INSERT') then
Message( G$_NLS.Get('X', 'FORM','*ERROR* Must SAVE record to run report.' )
);
Raise Form_Trigger_Failure;
end if;
-- --

lv_list_id := GET_PARAMETER_LIST('input_params');
IF NOT Id_Null(lv_list_id) THEN
DESTROY_PARAMETER_LIST(lv_list_id);
END IF;
```

```
lv_list_id := CREATE_PARAMETER_LIST('input_params');
-- --

IF :DISPLAY_PMS_CODE IS NOT NULL THEN
ADD_PARAMETER(lv_list_id,'PARM01',TEXT_PARAMETER,:DISPLAY_PMS_CODE);
ADD_PARAMETER(lv_list_id,'PARM02',TEXT_PARAMETER,'');
ADD_PARAMETER(lv_list_id,'PARM03',TEXT_PARAMETER,'S');
ELSE
ADD_PARAMETER(lv_list_id,'PARM01',TEXT_PARAMETER,'');
ADD_PARAMETER(lv_list_id,'PARM02',TEXT_PARAMETER,:FRR269R_GRNT_CODE);
ADD_PARAMETER(lv_list_id,'PARM03',TEXT_PARAMETER,'M');
END IF;
ADD_PARAMETER(lv_list_id,'PARM04',TEXT_PARAMETER,TO_CHAR(:FRR269R_PERIOD_
TO_DATE,'DD-MON-YYYY'));
-- --

:G$_BANNER_REPORT_HEADER.LIST_PARAM_NAMES := <--- ADD LINE

'PARM01' || ':' || 'PARM02' || ':' || 'PARM03' || ':' || 'PARM04'; <--- ADD LINE

G$_BANNER_REPORT_PROCESSING.START_REPORT_WINDOW('FRR269R','Y');
END;
```

4. Create an appropriate entry for the audit trail, save the .fmb file, and generate the .fmx file.

7.1 Changes for Oracle Reports RDF Files

Changes were made in Release 7.1 to all BASELINE Oracle Reports RDF files. You will need to make these same changes to custom Oracle Reports at your site.

Note

Make these changes only after you have completed all 7.0 changes. ■

Description of Changes

Before opening the equivalent to the BASELINE 7.0 version of the RDF file for modification, be sure that your REPORTS_PATH can see the 7.1 version of goqorep.pll.

1. Open the equivalent to BASELINE 7.0 version of the RDF file for modification using Reports*Builder10g.

2. Attach the goqorep to the RDF.

Enter the name in all UPPERCASE letters with no file extension, and then press the **Attach** button. After attaching, you can expand the library to view the audit_trail_7_1, which you will see if your REPORTS_PATH is as described above.

3. Expand the Report triggers and add the code below to the AfterReport:

```

function AfterReport return boolean is
begin
G$_REPORT_SECURITY.G$_REPORT_REVOKE_ACCESS;
return (TRUE);
exception
when others then
return (FALSE);
end;

```

4. Make the following *DELETE* and *ADD* lines to the BeforePForm function. Please note that the lines marked <---ADDXXX, <---ADDYYY, and <---ADDZZZ in the example code below refer to BASELINE object FRR272B and release number 7.1. These values, of course, will depend on the object you are modifying and the release of these corresponding changes.

```

function BeforePForm return boolean is
--
-- NRSmith 06/23/2004
-- Core contents of this trigger pulled from OracleTechnologyNetwork (OTN) site as
-- per a trouble shooting example to aid with migration to OracleDS10g*Reports
-- OTN Doc ID = Note:139546.1
--
vc_parameter_form varchar2(4000);
vc_hidden_runtime_values varchar2(1000);
vc_report_name varchar2(100);
hold_cmd VARCHAR2(240);
-- <---ADD
obj ORA_JAVA.OBJECT; <---ADD
x VARCHAR2(100); <---ADD
exc ORA_JAVA.OBJECT; <---ADD
<---ADD
-- Exceptions. <---ADD
-- <---ADD
NO_OBJECT          EXCEPTION; <---ADD
NO_INST            EXCEPTION; <---ADD
NO_ACCESS          EXCEPTION; <---ADD
NO_PASSWORD        EXCEPTION; <---ADD
INVALID_VERSION    EXCEPTION; <---ADD
INVALID_ACCESS     EXCEPTION; <---ADD
NAME_MISMATCH      EXCEPTION; <---ADD
-- <---ADD

-- Exception pragmas. <---ADD
-- <---ADD
PRAGMA EXCEPTION_INIT(NO_OBJECT,-20100); <---ADD
PRAGMA EXCEPTION_INIT(NO_INST,-20101); <---ADD
PRAGMA EXCEPTION_INIT(NO_ACCESS,-20102); <---ADD
PRAGMA EXCEPTION_INIT(NO_PASSWORD,-20103); <---ADD
PRAGMA EXCEPTION_INIT(INVALID_VERSION,-20104); <---ADD
PRAGMA EXCEPTION_INIT(INVALID_ACCESS,-20105); <---ADD
PRAGMA EXCEPTION_INIT(NAME_MISMATCH,-20106); <---ADD
-- <---ADD
begin
-- <---ADD
-- -- Start Security Check <---ADD
G$_REPORT_SECURITY.G$_REPORT_VERIFY_ACCESS( 'FRR272B', '7.1' ); <---ADDXXX
-- -- End Security Check <---ADD
-- <---ADD
if :P_Pass = 'INSECURED' then <---DELETE
return (TRUE); <---DELETE
end if; <---DELETE
-- <---DELETE

```

```

if :P_Role IS NOT NULL then <---DELETE
-- 81278 Dev6i Patch10 seems to strip away double quotes-they are needed <---DELETE
  if substr(:P_Pass,1,1) = chr(34) then <---DELETE
    Hold_Cmd := :P_Role||' IDENTIFIED BY '||:P_Pass; <---DELETE
  else <---DELETE
    Hold_Cmd := :P_Role||' IDENTIFIED BY '||chr(34)||:P_Pass ||chr(34); <---DELETE
  end if; <---DELETE
  DBMS_SESSION.SET_ROLE(Hold_Cmd); <---DELETE
end if; <---DELETE
-- If Reports is called from the URL and not from Forms then p_action is
-- set to its default value. In this case the hidden_value has to keep the
-- default value too.
  If (:p_action='_action_') then
    vc_hidden_runtime_values:='_hidden_';
else
-- -- The Report is started from Run_Report_Object and the hidden parameter has to be
set.
-- -- get the report module name
  srw.get_report_name(vc_report_name);
-- -- Note the only custom defined parameters are :p_action,:p_user_connect,
-- -- :p_servername. If there are additional parameters used for your Report
-- -- that are being passed from the form that need to be hidden,
-- -- these need to be added to the "vc_hidden_runtime_values" string
  vc_hidden_runtime_values:='re-
port='||vc_report_name||'&destype='||:destype||'&desformat='
||:desformat||'&userid='||:p_user_connect||'&server='||:p_servername;
  end if;

  vc_parameter_form:='<html><body bgcolor="#ffffff"><form method=post action="'
||:P_ACTION||'">'||'<input name="hidden_run_parameters" type=hidden value="'
||vc_hidden_runtime_values||'">'||'<center><p><table border=0 cellspac
ing=0><tr><td>'
||'<input type=submit></td><td width=15><td><input type=reset></td>'||'</tr></ta
ble><p><hr><p>';
-- -- set the modified before form value, overwriting the default.
-- -- If you want to change the look of the parameter form then you
-- -- can do this here as well
  srw.set_before_form_html (srw.text_escape, vc_parameter_form);
  return (TRUE);
--
exception
  WHEN NO_OBJECT THEN <---ADD
    SRW.MESSAGE(1000,'*ERROR* No parameters were passed - report terminated.');
```

```

-- <--ADD
  WHEN NO_ACCESS THEN <--ADD
    SRW.MESSAGE(1000,'*ERROR* User not authorized to access FRR272B - report termi-
nated. '); <--ADDDDD
    return (FALSE); <--ADD
-- <--ADD
  WHEN NO_PASSWORD THEN <--ADD
    SRW.MESSAGE(1000,'*ERROR* No password found on GUBROLE - report terminated. ');<--
ADD
    return (FALSE); <--ADD
-- <--ADD
  WHEN INVALID_VERSION THEN <--ADD
    SRW.MESSAGE(1000,'*ERROR* Invalid version of FRR272B - report terminated. '); <--AD-
DZZZ
    return (FALSE); <--ADD
-- <--ADD
  WHEN INVALID_ACCESS THEN <--ADD
    SRW.MESSAGE(1000,'*ERROR* Invalid password tried - report terminated. '); <--
ADD
    return (FALSE); <--ADD
-- <--ADD
  WHEN ORA_JAVA.EXCEPTION_THROWN THEN <--ADD
    SRW.MESSAGE(1000, '*ERROR* Report Server Configuration - report terminated. ');<--
ADD
    ORA_JAVA.CLEAR_EXCEPTION; <--ADD
    return (FALSE); <--ADD

-- <--ADD
  WHEN OTHERS THEN <--ADD
    SRW.MESSAGE(1000,'ERROR: ' || SUBSTR(SQLERRM,1,190)); <--ADD
    --SRW.MESSAGE(1000, '*ERROR* Before Parm trigger could not set database role - re-
port terminated. '); <--ADD
    return (FALSE); <--ADD

when others then <--DELETE
  SRW.MESSAGE(1000, '*ERROR* Before Parm trigger could not set database role - re-
port terminated. '); <--DELETE
  return (FALSE); <--DELETE
end;

```

5. Create an appropriate entry for the audit trail, save the RDF file, and convert it to a REP file.

General PL/SQL Oracle*Reports Library (GOQOREP)

Release 7.0 Changes

This library was changed extensively in Release 7.0 to:

1. Use Oracle's RUN_REPORT_OBJECT
2. Provide the optional Report Value window to the forms (other than GJAPCTL) that invoke Oracle*Reports.

Release 7.1 Changes

With Release 7.1, the G\$_SCT_RUN_REPORTS package replaced G\$_SCT_RUN_REPORT, and three other packages were added:

- BANNERID Java Imported Package
- EXCEPTION_ Java Imported Package
- G\$_REPORT_SECURITY Package

The G\$_BANNER_REPORT_PROCESSING package was changed to include a p_report_param_name_list parameter in the PROCESS_REPORT function.

Release 7.3 Changes

With Release 7.3, the G\$_REPORT_VPDI package was added to the library to support Multi-Entity Processing (MEP) using Virtual Private Database (VPD). In addition, two new functions were added to the G\$_SCT_RUN_REPORT_SERVER and G\$_SCT_RUN_REPORT_ONLINE procedures:

- p_vpdi_home_code
- p_vpdi_process_code

The RUN_REPORT_OBJECT

The G\$_SCT_RUN_REPORTS procedure (which replaced G\$_SCT_RUN_REPORT in Release 7.1) uses the new RUN_REPORT_OBJECT provided in the Oracle*Developer Suite 10g toolset. This allows you to specify:

- The format of the report (PDF, HTML, RTF, XML, etc.)
- The destination type of the report (CACHE, FILE, MAIL, or PRINTER)
- Where you want the report to be sent (either a file location or, if the destination type is MAIL, an e-mail address)
- The execution mode (BATCH or RUNTIME)
- Whether the report should be run synchronously or asynchronously
- Whether the Oracle Report parameter form should appear to display the existing parameters and allow you to change them

The parameters and corresponding data types for this procedure are:

Parameter	Datatype
p_report_id	REPORT_OBJECT
p_report_filename	VARCHAR2
p_report_server	VARCHAR2

Parameter	Datatype
p_report_service	VARCHAR2
p_report_desformat	VARCHAR2
p_report_destype	VARCHAR2
p_report_desname	VARCHAR2
p_report_execution_mode	VARCHAR2
p_report_comm_mode	VARCHAR2
p_paramlist	PARAMLIST
p_report_success	BOOLEAN

 **Note**

p_report_success is an output parameter that communicates the success or failure of the job or report to the Job Submission Form (GJAPCTL). This enables you to use GJAPCTL to clean up GJBPRUN rows. ■

The Optional Report Value Window

Banner allows you to use the Oracle Report Value Window to review and, if necessary, change various processing parameters for your job. It is not available when you run a report via GJAPCTL; it would show the same information as GJAPCTL. It is available for forms like the Standard Billing 270 Form (FRR270B), where you can enter data into the form, then run the report via the Options menu.

G\$_BANNER_REPORT_EDITING and G\$_REPORT_PROCESSING support using this window in Banner.

The core routine that is invoked when you run a report is G\$_BANNER_REPORT_PROCESSING.START_REPORT_WINDOW. If job submission parameter 77 is *YES* (or is not found), the Report Value Window is displayed and the G\$_BANNER_REPORT_BLOCK's when-button-pressed trigger will accept input from the window - users can change report parameters 71-76 on the fly. When the user selects Run Report, the PROCESS_REPORT routine is fired and the report is run.

If, however, job submission parameter 77 is *NO*, the Report Value Window is not displayed. The Parameter Definition values for the report (or default values if no Parameter Definition values exist) are loaded for parameters 71-76, and the PROCESS_REPORT routine runs using them.

All items in the Report Value Window have edit routines established for them in the G\$_BANNER_REPORT_EDITING package. Many of these routines are stub edits, which have

been established so that the library objects (.pll and .plx) can be changed and redeployed without requiring you to regenerate and redeploy any other form objects.

The `G$_BANNER_REPORT_EDITING.EDIT_OREP_ROW` routine has been delivered with Release 7.0 to enable you to edit the Report Value Window row.

 **Note**

Certain values and combinations of values are not permitted for parameters 71-77. See “Setting Up Default Values for Parameters 71-77,” earlier in this chapter, for restrictions on values. ■

Report Forms Object Library (GOORLIB)

The User Interface (UI) items associated with the optional Report Value window are found in forms that have referenced or been sub-classed in the object group `G$_BANNER_REPORT` from the new UI library form `GOORLIB`.

With Release 7.1, the following items were added to the `G$_BANNER_REPORT_HEADER` block of the `G$_BANNER_REPORT` object group:

- `REPORT_BEAN`—Accommodates Oracle Reports security layer implementation.
- `LIST_PARAM_NAMES`— Holds the names of parameters (i.e. `PARM01`, `PARM02`, etc.) that pass values to the report. In `goqorep.pll` routines, this item is parsed to extract parameter names. These parameter names are then used to extract the corresponding value from the `LIST` item.

Dynamic Procedure Library (GOQRPLS)

A new function, `G$_GET_UPRF_WEBRPT_SERVICE`, was added to retrieve the values for the new Oracle Reports Service Name entry on `GUAUPRF`, namely:

Key	Value
<code>GURUPRF_GROUP</code>	<code>REPORT</code>
<code>GURUPRF_KEY</code>	<code>WEB</code>
<code>GURUPRF_STRING</code>	<code>SERVICE</code>

Reports in Banner General

Banner General Pro*C and Pro*COBOL reports are listed in Chapter 15, “Reports and Processes,” of the *Banner General User Guide*.

Perl Reports

Banner General contains the following Perl reports and processes:

<code>gebcmplc.pl</code>	General Master Pro*C compile script
<code>gencmpl.pl</code>	General Master COBOL compile script
<code>gjajobs.pl</code>	Main Job Submission script invoked by the <code>gurjobs C</code> program
<code>gjajsub.pl</code>	Called by <code>gjajobs.pl</code> to do the actual submission of a process to the operating system
<code>gjawnnte.pl</code>	Obtains the Banner and Oracle Windows NT Environment Variables from the NT Registry
<code>gjawnnts.pl</code>	Spawns <code>gjajsub</code> in the background (Windows NT submit)
<code>glbdata.pl</code>	Executes <code>GLBDATA</code>
<code>glblsel.pl</code>	Executes <code>GLBLSEL</code>
<code>gjbparm.pl</code>	Executes <code>GLBPARAM</code> and <code>GLOLETT</code>
<code>glolett.pl</code>	Executes <code>GLOLETT</code>
<code>glrletr.pl</code>	Executes <code>GLRLETR</code> and <code>GUAPRPF</code>
<code>guavrfy.pl</code>	Executes <code>GUAVRFY</code>
<code>gurjobs.pl</code>	Executes <code>GURJOBS</code>
<code>gurjwnt.pl</code>	Opens a background task in Windows and runs <code>gurjobs.pl</code>
<code>gurplb1.pl</code>	Takes in a Script Name and a number of seconds to sleep, then calls <code>gurplb2.pl</code> in the background
<code>gurplb2.pl</code>	Runs the script passed from <code>gurplb1.pl</code> looping and sleeping at the interval specified, which is also passed from <code>gurplb1.pl</code>
<code>sctproc.pl</code>	Banner C compiler
<code>sctprocb.pl</code>	Banner COBOL Compiler

Report and Process Attributes

Report and Process Attributes Legend

Report or Process	The report/batch process name.
Language	Identifies the language for the process - COBOL, C, RPT, SQL, or PL/SQL.
Update/Query	Does the process update any tables, or is it strictly a query-only report?
Audit	Can you run the update process in Audit Mode, so that you can produce the report without an update taking place (Yes or No)? Note: Yes appears in this column only if the process permits both update and audit mode. If the report is query only, Yes does not appear in this column.
Job Submission	Can you run the process via job submission (Yes or No)?
Sleep/Wake	Is the process used in conjunction with Sleep/Wake (Yes or No)?
Off Peak	Does SunGard recommend that you defer this program to an off-peak processing time (late night, weekends) for performance reasons (Yes or No)?
Restart	If the process aborts or is terminated after the process is initiated, are special procedures required to restart the process without any adverse consequences (Yes or No)? Note: Yes does not appear in this column if the job can be restarted without special procedures. If Yes appears, refer to the Restart section of this chapter for more information regarding recovery procedures.

Report or Process	Language	Update/Query	Audit	Job Submission	Sleep/Wake	Debug/Trace	Off Peak	Restart
GJRRPTS	C	Query		Yes				Yes
GLBDATA	COBOL	Update				Yes		Yes
GLBLSEL	COBOL	Update				Yes	Yes	Yes
GLBPARM	COBOL	Query		Yes				Yes
GLOLETT	COBOL	Update		Yes		Yes		Yes
GLRLETR	C	Update	Yes	Yes			Yes	Yes
GPPADDR	C	Update		Yes				Yes
GORPGEO	C	Update	Yes	Yes	Yes			
GORSEVE	C		Yes	Yes				

Report or Process	Language	Update/Query	Audit	Job Submission	Sleep/Wake	Debug/Trace	Off Peak	Restart
GORSSEO	C	Update	Yes	Yes	Yes			
GUAVRFY	COBOL	Query		Yes				Yes
GUAGETP	COBOL	Query						Yes
GUASETR	COBOL	Query						Yes
GUPDELT	C	Update	Yes	Yes		Yes		
GURDETL	C	Update		Yes		Yes		
GURHELP	C	Query		Yes				Yes
GURINSO	C	Update						Yes
GURPDED	C	Query		Yes				Yes
GURTABL	C	Query		Yes				Yes
GURTEXT	C	Query		Yes		Yes		
GURTPAC	C	Update	Yes					
GUSMDID	C	Update	Yes	Yes				

Trace Mode (Debug) for General COBOL Programs

Running a process in trace mode provides you with a step-by-step process history. It can be used to track down the source of an error message or to verify your place in the process.

Note

Trace mode is not available when you use Job Submission (see restrictions in the Report and Process Attributes Matrix) to run the process.

The following General COBOL programs may be executed in trace mode:

GLBLSEL - Letter Generation Variable Data Extract Process

Three options are available for trace mode. These options are controlled by the value of the debug flag parameter which is passed on the command line.

UNIX:	<pre>gblsel.shl userid password 1 GLBLSEL Y gblsel.shl userid password 1 GLBLSEL I gblsel.shl userid password 1 GLBLSEL S</pre>
Debug flag:	<p><i>Y</i> – display SQL, paragraph names and additional information <i>I</i> – display SQL and values inserted into the GLRCOLR table <i>S</i> – display SQL only</p>
VAX:	<pre>@gen\$com:gblsel userid password 1 GLBLSEL Y (substitute debug flag Y, I, S as desired)</pre>
Windows	<pre>perl -S gblsel.pl userid password 1 GLBLSEL Y or cd %BANNER_HOME%\general\misc perl gblsel.pl userid password 1 GLBLSEL Y</pre>



Note

The -S tells perl to look for the gblsel.pl in the PERL5LIB directory. ■

GLBDATA - Population Selection Extract Process

UNIX:	<pre>glbdata.shl userid password 1 GLBDATA Y</pre>
VAX:	<pre>@gen\$com:glbdata userid password 1 GLBDATA Y</pre>
Windows:	<pre>perl glbdata.pl userid password 1 GLBDATA Y</pre>

GLOLETT - Automatic Letter Compilation Process

UNIX:	<pre>glolett.shl userid password 1 GLOLETT DEBUG</pre>
VAX:	<pre>@gen\$com:glolett userid password 1 GLOLETT DEBUG</pre>
Windows:	<pre>perl glolett.pl userid password 1 GLOLETT DEBUG</pre>

For UNIX: In each of the above examples, | tee outputfilename are optional arguments that may be passed at the end of the command line examples. Adding | tee outputfilename will result in the output displayed on the screen to be simultaneously written to a file with the designated outputfilename. This file may be edited and searched for specific messages and/or errors.

For VAX: In the above example for GLOLETT only, /log = logfilename are optional arguments that may be passed at the end of the command line. GLBLSEL and GLBDATA cannot be submitted in a batch mode because the user is required to respond to interactive prompts. OpenVMS does not have an equivalent to the UNIX tee command which allows output to be written simultaneously to the screen as well as to an output file. When a problem is encountered, the error messages and pertinent information will be located in the final lines displayed from the debug output. Screen prints are a recommended method of obtaining a hard copy version of these messages.

For Windows: The Windows equivalent of the tee command is available with the purchase of the *Windows Services for UNIX Add-On Pack*. Please see <http://www.microsoft.com/technet>.

SQL*Plus Scripts

SunGard provides the following General SQL*Plus procedures to assist you.

delrslt.sql	Delete rows from GJBRSLT table.
dyndflt.sql	Default parameters for dynamic SQL procedures.
gchkbgrt.sql	Builds grants for the security owner to give it full access to all Banner tables installed for which it has no grants at all.
gchksec.sql	This SQL routine tests for all requirements for role-level security.
gchksecrole.sql	A SQL routine to test for local roles that do not adhere to the Banner suggested naming conventions that are used in providing access to Banner forms.
gchksyn.sql	Generates an SQL routine to create all missing Banner public synonyms.
gchkuser.sql	A script called by GUPUSER to verify that the upgrade_owner has all the required database objects.
gcreuser.sql	Creates the upgrade_owner and its required database objects.
gdeleqer.sql	Deletes rows from the Event Queue Error table based on a date.
gdeleqrc.sql	Deletes rows from the Event Queue Transaction tables based on a date.
gdelintl.sql	Implementaion of Multivisa 5.5. Deletes rows from the international tables GOBINTL, GORVISA and GORDOCM from SPRINTL. Revised for 7.3 redesign. Run before gselvisa.sql, gupdvisa.sql, and gdelsdaxvisa.sql.

<code>gdeljobs.sql</code>	Removes rows from job submission tables for products not available on your system.
<code>gdeloutp.sql</code>	Deletes rows from the Jobsub Database Output tables based on a date.
<code>gdelprun.sql</code>	Deletes leftover GJBPRIN entries for the GLOLETT program before recompiling. Used during upgrades only.
<code>gdelstdaxvisa.sql</code>	Deletes GTVSDAX international rows. Run after gselvisa.sql and gupdvisa.sql.
<code>gdiscon.sql</code>	Disables constraints that should remain disabled.
<code>gdroptab.sql</code>	Drops the GUBSMOD and GURSSQL tables before importing them. Used only during upgrades.
<code>gdrpsyn.sql</code>	Drops public synonyms for Banner objects which no longer exist. Used only during upgrades.
<code>gefifixadd.sql</code>	SQL*Plus script to set the <code>from_date</code> on SPRADDR records to the activity date when both from and to dates are null. Only to be run when BannerQuest is installed.
<code>genalug.sql</code>	Grants option for advancement tables.
<code>gencimg.sql</code>	Grants for courts tables and views.
<code>genfimg.sql</code>	Grants option for finance tables.
<code>genford.sql</code>	General foreign grant driver script.
<code>genpayg.sql</code>	Grants option for human resources tables.
<code>genresg.sql</code>	Grants option for financial aid tables. Replaces GENFAIG.SQL.
<code>genstug.sql</code>	Grants option for student tables.
<code>gentrag.sql</code>	Grants option for accounts receivable.
<code>genforg.sql</code>	Script that contains grants for INTEGMR (Integration Manager).
<code>gfgacdoppol.sql</code>	Script that drops policies on a table for package GOKFGAC.
<code>gfpiiaddpol.sql</code>	Script that adds policies for tables identified in GORFDPI.
<code>gfvsaddpol.sql</code>	Script that adds FGAC policies for tables identified in GORFDPL.

ggivedba.sql	Script used during the upgrade to alter the users involved with the upgrade to include the DBA role as one of their default roles. The script also generates a file used to restore the roles to what they were before the upgrade.
ggrtfnc.sql	Script can be used to generate grant execute statements to functions for users requiring execute privileges for SDA views.
ggrttmp.sql	Create temporary table used to build grants. This table only exists for the duration of this process.
gindex.sql	Creates a report of indexes for a schema owner.
ginsprun.sql	Inserts gjbprun rows for variables to be recompiled. Used only during upgrades.
gletgrts.sql	Upgrade script to give the General product the ability to run GLOLETT and GLBPARAM during the upgrade.
glramod.sql	Process to check if specific modifications have been applied to the database.
gmakalt1.sql	GOSTAGE script which invokes guraltg.sql.
gmakgrt.sql	This process builds grants for the table names loaded into the GUBGRNT table.
gmakgrtv.sql	New routine to save grants, then re-issue them from BANINST1.
gnestedv.sql	Utility script that lists nested variables. Used during upgrades.
gnewgrt.sql	Generates end user grants.
gostage.sql	This process is the heart of the upgrade process. It determines what modifications in the GUBSMOD and GURSSQL tables have to be applied to your system.
greadme.doc	A text file that lists and describes all the scripts in the general/plus directory.
gresroled.sql	This script starts a spooled script, gresrole.sql, that was generated by ggivedba.sql to restore the original roles.
grunsiz.sql	This process runs all the standard table sizing model scripts. The start for this file is automatically generated by the glramod routine. Used during the upgrade process.
gsafobj.sql	SQL routine used during upgrades to register changes to an object if it exists.

<code>gsanobj.sql</code>	Adds new objects to bansecr's security tables. Used during upgrades.
<code>gsaobj.sql</code>	Deletes obsolete objects from bansecr's security tables. Used during upgrades.
<code>gsdrslt.sql</code>	Deletes any leftover GJBRSLT records for the staging job.
<code>gselappl.sql</code>	This script will extract the application and the creator of components of the application so the user will know what to respond with and who to sign on as when running GLBPARM and GLOLETT.
<code>gselevs.sql</code>	Data fields <code>GORSEVS_ISSUE_COMMENT</code> and <code>GORSEVS_TRANSFER_COMMENT</code> are no longer used for SEVIS reporting. This script allows users to retrieve data from the latest history record.
<code>gselvisa.sql</code>	Selects form <code>GORVISA</code> for <code>GTVSDAX</code> records that are retired from use. Run before <code>gupdvisa.sql</code> and <code>gdelsdaxvisa.sql</code> .
<code>gsirslt.sql</code>	Inserts a record in the results table to indicate the task completed successfully.
<code>gskipgrt.sql</code>	Script which skips the generation of end user grants. Used during the upgrade process.
<code>gstrslt.sql</code>	Test if a hosted SQL*Plus routine succeeded. This routine tests if the hosted routine was able to insert a row into the GJBRSLT table. If the row is not found an SQL error is caused that will stop the current routine.
<code>guidmod.sql</code>	Insert history record into the <code>GENERAL.GURDMOD</code> table. Used during upgrades.
<code>guitmod.sql</code>	Insert history record into the <code>GENERAL.GURDMOD</code> table if the mod has not already been recorded. Used during upgrades.
<code>guovmods.sql</code>	Script to create view <code>GUVMODS</code> under the <code>upgrade_owner</code> created via <code>gupuser.sql</code> .
<code>gupdintl.sql</code>	Conversion script to migrate data from <code>SPRINTL</code> in General 5.5. Conversion script revised for the redesign of <code>GORVISA</code> for 7.3.
<code>gupdvisa.sql</code>	Script to updated <code>gorvisa</code> and <code>gordocm</code> columns to null for old <code>GTVSDAX</code> international values. Run after <code>gselvisa</code> and before <code>gdelsdaxvisa.sql</code> .
<code>gupuser.sql</code>	Script to create an upgrade user account to be used in parallel upgrades.

<code>guraltb.sql</code>	This utility script will spool off a sqlplus script to compile all invalid functions and views owned by BANINST1.
<code>guraltg.sql</code>	This utility script will spool off a sqlplus script to compile all invalid functions and views. Used by the gostage process.
<code>guraltr.sql</code>	This utility script will spool off a sqlplus script to compile all invalid functions and views.
<code>guramod.sql</code>	Create the table used to build the modification scripts.
<code>gurcmod.sql</code>	Process to check if specific modifications have been applied to the database. Information is placed into the guramod table indicating what scripts have been executed already and what ones still have to be run.
<code>gurcmpa.sql</code>	Spools a script to compile all database objects that are not owned by either SYS or SYSTEM.
<code>gurcmnt.sql</code>	Creates COMMENT ON COLUMN statements for a table in proper format to an Oracle directory.
<code>gurconsumer.sql</code>	Script to provide privileges to enqueue and dequeue messages to Oracle users.
<code>gurcrypt.sql</code>	Script to encrypt all passwords.
<code>gurddoc.sql</code>	Script to extract database object comments.
<code>gurdld.sql</code>	Script used to delete all information about a PIDM in the database.
<code>gurdmod.sql</code>	Create the table to track database modifications.
<code>guremod.sql</code>	This process is executed at the end of each products xREVTAB and xREVIEW script. This process extract information stored in the guramod table for this user ID and then executes it.
<code>gurespl.sql</code>	Script to generate an exit statement and close the spool file.
<code>gurethnicity.sql</code>	Script to capture race and ethnicity in SPBPERS and GORPRAC.
<code>gurfgrt.sql</code>	Generates an intermediate sql routine that will issue a foreign grant for a table only if it exists. You must be logged on as system to use this routine.
<code>gurgfix.sql</code>	Script to generate and create any missing grants after the security patch has been applied.
<code>gurgfix2.sql</code>	Script to generate and create any missing grants after the security patch has been applied. Use this script instead of GURGFIX if your institution does not use Banner Self-Service.

gurgmnt.sql	Creates a file of GRANT statements based on a model user (replaces GRANTS in the ORATOOLS directory).
gurgrtb.sql	Script to grant execute privilege on the BANINST1-owned stored procedure passed as the first argument to Banner owners and roles.
gurgrth.sql	Script to grant execute privilege on the BANINST1-owned stored procedure passed as the first argument to local web server user IDs.
gurgrti.sql	Script to grant execute privilege on the BANINST1-owned stored procedure passed as the first argument to the Integration Manager.
gurgrts.sql	Script to grant execute privilege on the BANINST1-owned stored procedure passed as the first argument to the Banner security owner.
gurgrtw.sql	Script to grant execute privilege on the Web Tailor-owned stored procedure passed as the first argument to the Banner stored procedure owner, the database roles, and the local web server user IDs.
gurgrt3.sql	Script to grant execute on the BANINST1-owned stored procedure passed as the first argument to the e~Print user.
gurlsid.sql	Lists of all tables and columns in which a person exists.
guromod.sql	This process is executed at the beginning of each products xREVTAB, xREVIEW and xTABCLN script to delete any old entries left in the GURAMOD table for this user ID.
gurosp1.sql	Script to set SQL*PLUS options and open a spool file names by parm1. This script is always used by a driver script.
gurddl.sql	Script to PL/SQL script which generates DDL syntax for a specified table(s). Note: This script was made obsolete in Release 8.1 favor of data definition language (DDL) tools provided by Oracle. Oracle's Metadata API and DBMS_METADATA package provide more extensive functionality than gurddl.sql did, and will remain current with future Oracle updates. For more information, see <i>Oracle Database Utilities</i> and <i>PL/SQL Packages and Types Reference</i> in Oracle's technical documentation.
gurrhmu.sql	Script that invokes a refresh of the hierarchial menu table GURHMNU.
gursava.sql	SQL routine that creates SQL*PLUS define commands that contain all the information need to recreate a table the same size and in the same place that it currently exists. Cluster information is not retained.

<code>gursava2.sql</code>	SQL routine to save index/table info no matter who owns it.
<code>gurscls.sql</code>	This script checks every person enrolled in the class to make sure they have been given execute privileges to every role used by any object in the class.
<code>gurstop.sql</code>	Invoke this routine to stop job submission.
<code>gurtgr1.sql</code>	This routine is used by the GURTGRT routine to build grants for a new table based on grants for an existing table.
<code>gurtgr2.sql</code>	Copy Best Guess generated grants from the work table to a spool file. The output from this select is ordered by grantor to reduce the number of connect commands that must be executed.
<code>gurtgr3.sql</code>	Generate report for the best-guess grants generated by GURTGRT and GURTGR1.
<code>gurtgr4.sql</code>	Script to generate grants for views using tables as model. Used during upgrades.
<code>gurtgr5.sql</code>	Script to generate grants for tables based on another owners table. Used during upgrades.
<code>gurtgrt.sql</code>	Generates an intermediate sql routine that will create grants to access a new table based on existing grants for a similarly used table. You have the option of using up to three tables to match. You should be logged on as the grantor (owner of the new table) to run this routine.
<code>gurtgrto.sql</code>	Used in conjunction with GURTGR5.
<code>gurtgrtv.sql</code>	Used in conjunction with GURTGR4.
<code>gurtlst.sql</code>	Produces list and description of a Banner product's tables.
<code>gurtprt.sql</code>	Prints contents of a specified table.
<code>gurutlrp.sql</code>	This utility script calls Oracle's utlpr routine which validates database objects in dependency order. A report is spooled.
<code>gurvlst.sql</code>	Produces list and description of all validation tables in a Banner product.
<code>gutemod.sql</code>	This process is executed at the end of each products xREVTAB script. This process extract information stored in the guramod table for this user ID and then executes it.
<code>gutfmod.sql</code>	Process to prime the gurdmod table if the constraint exists.

gutnmod.sql	This script will insert a row in the gurdmod if the specified object does not exist. This would be used to conditionally run an upgrade script only if the table is present.
gutpmod.sql	Process to prime the GURCMOD table based on an objects existence.
guttmod.sql	Process to prime the GURCMOD table based on columns existence.
iobseqn.sql	Primes the SOBSEQN table after creation.
login.sql	Default SQL*Plus Login parameters.
repdf1t.sql	Default SQL*Plus parameters to produce a report.
sleepcms.sql	This is a generic SQL process for VM/CMS which causes operating-system-dependent command procedures to be executed for batch processes which require sleep/wake capabilities.
sleepdec.sql	This is a generic SQL process for OpenVMS which causes operating-system-dependent command procedures to be executed for batch processes which require sleep/wake capabilities.
sleepunx.sql	This is a generic SQL process for UNIX which causes operating-system-dependent command procedures to be executed for batch processes which require sleep/wake capabilities.

Sleep/Wake Methods

Banner provides two different methods for running jobs in a cyclical, or sleep/wake, mode.

Method One

The first method uses OS command scripts and an SQL*Plus script to cause the job to run in a cyclical fashion. These jobs must be submitted from the operating system prompt and must be terminated manually. To compile programs to run in this fashion, you must define `NO_SLEEP_SW` as a pre-compiler directive to exclude the code used by the second technique.

Seven programs are affected by the value `NO_SLEEP_SW` as a pre-compiler directive:

- `sfrschd.pc`
- `shrtrtc.pc`
- `tgphold.pc`

- tgrmisc.pc
- tgrrcpt.pc
- tsrabil.pc
- tsrsum.pc

Note that `NO_SLEEP_SW` only affects the Student and Accounts Receivable processes.

UNIX

The first command procedure, `sleepunx`, prompts for parameters needed by the second procedure and SQL*Plus script, `sleepunx.shl` and `sleepunx.sql` respectively. This procedure then starts (or submits) `sleepunx.shl`, which in turn starts `sleepunx.sql`. The SQL*Plus script `sleepunx.sql` will spool OS-specific commands to run the job into a file, provided there is actually work to do as determined by the parameters previously entered. When the SQL*Plus script exits, `sleepunx.shl` executes the spool file. The parameters needed by the program are contained in a `XXXXXXXX.dat` file which are read via input redirection when the job executes. The second command procedure `sleepunx.shl` then sleeps for the specified interval, awakes, and loops back to start the SQL*Plus script again.

To define `NO_SLEEP_SW` on UNIX, go to `sctproc.mk` and find the lines:

```
# Other C options
CCOPT=
```

Change these lines to:

```
# Other C options
CCOPT=-DNO_SLEEP_SW
```

OpenVMS

This is essentially the same as for UNIX. The script names are `sleep.com`, `sleepdec.com`, and `sleepdec.sql`. Command input redirection is accomplished by defining `sys$input` as the `.dat` file. The “sleeping” is done with the “wait” command.

To define `NO_SLEEP_SW` on OpenVMS, specify `p2` as a placeholder so you can get to `p3`. Specify the following additional macro definition:

```
@gen$com:sctproc sfrschd "limited" "NO_SLEEP_SW"
```

Save this change and recompile all sleep/wake programs which will be affected by the change.

Note

This option should be done for programs which are run using Method 1 of sleep/wake mode. ■

Windows

Method one is not valid for Windows platforms.

Method Two

The following Banner systems and processes are valid for the Sleep/Wake processing described in this section:

Banner Student

SFRSCHD- Student Schedules
SHRTRTC- Academic Transcript

Banner Accounts Receivable

TGRRCPT- Account Receipt
TGRMISC- Miscellaneous Receipt
TSRCBIL- Student Billing Statement (Invoices)
TSRSSUM - Student Transaction Summary Report

1. Define printer and print command on the Printer Validation Form (GTVPRNT). In the **Printer Code** field, enter a name to reference each specific printer that may be used for printing output from sleep/wake processing. In the **Command** field, enter the correct operating system print command as it would normally be entered from the command line prompt, substituting an @ (at sign) as the place holder for the file name to be printed.

UNIX example: `lp -d talaris1 @`

OpenVMS example: `print/queue=ln01 @`

Windows example: `print /d:\\sctrnt0\XeroxDC230 @`

2. On the appropriate System Distribution Initialization Information Form (SOADEST for Student or TOADEST for Accounts Receivable), enter the printer Code from GTVPRNT that should be identified with the collector table rows that will be inserted to the appropriate tables when on-line application forms create a request for output that can be generated by sleep/wake processing.

The collector tables are as follows:

Process	Collector Table
SFRSCHD	SFRCBRQ
SHRTRTC	SHTTRAN
TGRMISC	TBRCMIS

Process	Collector Table
TGRRCP	TBRCRCP
TSRCBIL	TBRCBRQ

- On the Process Submission Control Form (GJAPCTL), for the valid sleep/wake jobs listed previously, enter the correct response for the parameter that specifies that the job should be processed for collector table entries. Refer to the documentation for each specific process to determine the appropriate response in each case (correct responses may be COLLECTOR, Y, %, etc.). In addition, each sleep/wake job has a printer code parameter. You must specify exactly the same code for this parameter answer that was entered on either SOADEST or TOADEST. Enter *Y* for the run in sleep/wake mode parameter and specify the number of seconds for the sleep/wake interval (cycle) for each process.

 **Note**

Do not enter the printer code in the top block of GJAPCTL; only enter it in the parameter section. ■

- The Sleep/Wake Maintenance Form (GJASWPT) should be used to stop the sleep/wake process or to change the sleep interval. A process name and printer code must be entered in the key. A LIST of values is available in each field to see the valid list of processes and printer codes that have ever been submitted for sleep/wake processing.

To stop the process, enter *N* in the Continue to Run field and SAVE. The job will not stop immediately, but rather will stop after the next time the process 'wakes up' and finishes the next processing cycle. To change the sleep interval, enter the desired interval in the Next Cycle Time field and save.

The GJASWPT form can also be used to view statistics regarding how many rows were processed for the most recent wake-up cycle and the total number of rows processed since the process was initiated. You can also determine if the processes terminated abnormally, by viewing the Abnormal Termination field. If there is a *Y* in Abnormal Termination, something caused the process to fail. You should review log files to determine the cause.

Operating Systems Without Sleep/Wake-up Commands

Operating systems which do not have sleep commands, or whose sleep commands may not be executed by user programs, must use the Method One.

Job Submission

While the external mechanics of submitting a job is the same across all operating systems, the internal processing is operating system specific. Because of differing releases of the OS and local modifications that may have been made, these procedures may not run exactly as delivered. Therefore some modifications may be required.

Before a job can be submitted, it must be defined on the Process Maintenance Form (GJAJOB) and the appropriate security privileges must be granted for the object. Information from this form and from the O/S field found on Installation Control Form (GUAINST) control how the command to run the job is built. On the GJAJOB form, the Type field indicates the type of program to be executed.

There are four job types:

1. *C* - Pro*C program
2. *E* - Standalone COBOL program. Banner no longer has any type E jobs, the value remains for compatibility. These types of jobs may not use parameters since no mechanism is provided to pass them.
3. *P* - Procedures. These types of jobs cause operating system specific scripts to be run. (Bourne Shell, VAX/OpenVMS command procedure, or Perl).
4. *R* - Oracle Report

The Command Name, if entered, will be used as the actual name of the program to run. If it is null, the Name from GJAJOB will be the name of the program to run. This field should never contain an extension. The extension, if needed, is appended by either the Job Submission Interface Form (GUQINTF) or the operating system specific GJAJOB command procedure.

Jobs may be submitted from either a product's application form or from General's Process Submission Control Form (GJAPCTL).

Jobs Submitted from GJAPCTL

The GJAPCTL form provides for the entry and editing of parameters and executes any process level validation associated with the job. Process level validation is defined on the GJAJOB form in the **Validation** field and refers to the name of a procedure contained in the product specific validation package stored in the database.

The name of the package is the product's system indicator, as defined on the System Indicator Validation Form (GTVSYSI), appended with the literal OKPVAL; General's package is GOKPVAL.

Parameters are inserted into the Process Run Parameter Table (GJBPRUN) using a unique sequence number generated from General's GJBPSEQ sequence to identify the job request. The GJAPCTL form then sets `global.call_form` to GJAPCTL and calls the GUQINTF form (described later).

Jobs submitted from the GJAPCTL form will always use GJAJOBS as the command procedure to run. Depending on your operating system and the type of job being run, the GJAJOBS command procedure may further modify the command name passed to it from the GUQINTF form.

For example, in the UNIX environment GJAJOBS.SHL constructs the operating system command as follows:

- For *E* type jobs - the jobs name is prefixed by the COBPREF environment variable and suffixed by the COBSUFEX environment variable.
- For *P* type jobs - the literal `.shl` is appended to the end of the command name.
- For *C* type jobs - the command name is not modified.

If the command name for a type *P* job had specified an extension, another one would be added automatically.

 **Note**

Interactively entering job parameters from the host is no longer supported. Parameters for all jobs must be entered on GJAPCTL. ■

Jobs Submitted from Application Forms

Requests from application forms typically do not allow you to enter parameters because they are usually obtained from information contained on the form itself. The application form will usually assign values to globals, then call the GUQINTF form. GUQINTF is discussed below.

If the job is to be submitted from a form other than GJAPCTL, a command procedure must exist for the job. If the **Command Name** field on the GJAJOBS form is not used, the job name itself is used as the name of the command procedure. These types of requests are handled by a call to the GUQINTF form which builds the initial host command. Again, depending on the operating system, an extension may be added to the command name before it is executed. Prior to calling GUQINTF the global named `GLOBAL.JOB_ID` is set to the name (without extension) of the program to be executed and the global named `GLOBAL.CALL_FORM` is set to the name of the current form. If the GJBPRUN table has been populated with parameters, the global named `GLOBAL.ONE_UP_NO`, is set to the one up number used when the rows were inserted.

If the program is to be executed immediately from a form and the operating system is OpenVMS, a symbol will need to be created (see GUASENV.COM).

The GUQINTF Form

The GUQINTF form performs several tasks. First, the `WHEN-NEW-FORM-INSTANCE` trigger tests `GLOBAL.CALL_FORM` to see if the request came from `GJAPCTL`. If it did, the form level trigger `JS_HOST_COMMANDS` is executed. This trigger builds a message containing the following information:

Command Name	GJAJOBS
job type	A one-character code representing the type of job: <i>E</i> - executable COBOL program <i>P</i> - operating system command procedure <i>C</i> - PRO*C
user_name	Current Oracle username or alternate username if entered on the Alternate Logon Verification Form, (GUAUIPW)
password	Password for username
one_up_no	One-up number generated from the GJBPSEQ sequence.
printer name	Comes from the GJAJOBS form or the GJAPCTL form.
special forms name	Comes from the GJAJOBS form or the GJAPCTL form.
submit time	This is from the GJAPCTL form and is currently only passed to the GJAJOBS procedure. No mechanism exists in the procedure to schedule the job due to the wide variety of supported operating systems.

Requests submitted from forms other than `GJAPCTL` come in two types: those that populate the `GJBPRUN` table before calling `GUQINTF`, and those that don't. If the form does not populate the `GJBPRUN` table, login must exist in the `GUQINTF` form to do it.

For example, requests coming from the `TSASPAY` form execute the form level trigger `STUDENT_PAYMENT` which forces an update to the `GJBPRUN` table.

The block level `POST-INSERT` or `POST-UPDATE` trigger fires then, executing a common trigger to actually do the inserts.

The `STUDENT_PAYMENT` trigger is executed immediately before the `HOST_COMMANDS` trigger in the `WHEN-NEW-FORM-INSTANCE` trigger. The `HOST_COMMANDS` trigger is then builds a message containing this information:

command_name	Either the job name or the command name from the GJAJOB form. Then, based on the operating system as defined on GUAINST, an extension may be added or a prefix may be added. On Windows platforms, perl prefixes the command name. On UNIX, .shl is appended.
user_name	Current Oracle username or alternate username if entered on the Alternate Logon Verification Form, (GUAUIPW)
password	Password for username
one_up_no	One-up number generated from the GJBPSEQ sequence
job_name	Either the job name or the command name without an extension (uppercase)
directory	Name of the directory where output from the job will go

After this message is built, the form level trigger PIPEIT is executed which sends the message to the GURJOBS application server program by executing the DBMS_PIPE.SEND_MESSAGE function.

After sending the message, requests that came from the GJAPCTL form return to that form immediately. Requests coming from other forms perform one more trigger named GET_STATUS. This trigger reads the External Process Results Table (GJBRSLT) to check for a message inserted by the batch job. The lack of an entry results in an error message being displayed stating that the job failed.

 **Note**

If the program does not use the GJBRSLT table, the GET_STATUS trigger still needs to be executed because globals are set which indicate success or failure. Returning to the calling form without setting these globals could result in unpredictable results. ■

Once GURJOBS receives the request, it fulfills it by executing the system function, using the command as the argument. See the section on GURJOBS for more information.

The following sections outline the processing for each of the currently supported operating systems.

UNIX

gjajobs.shl

A UNIX shell program called gjajobs.shl is started by the system function. This shell interrogates the parameters passed to it and builds another temporary shell to actually run

the job. The temporary shell consists of either the commands to execute and print a report, (based on a parameter from the GJAPCTL form), or commands to invoke a customized procedure for this job depending on the definition of the job on the GJAJOB form.

The gjajobs.shl then sets the following environment variables so they can be accessed by the started procedure, if necessary.

BANUID	The userid being used to run the job.
FORM	Special print options as specified on GJAJOB or GJAPCTL.
H	The HOME directory.
JOB	The name of the Job or Process to be executed.
LOG	Log file name.
ONE_UP	The one up number assigned at the time the job was submitted.
PRNT	The name of the Printer as specified on GJAJOB or GJAPCTL.
PRNTOPT	The complete print command built from PRNT and FORM
PROC	The name of the .shl file to be run.
PROG	The name of the program to run, as indicated in the key block of GJAPCTL.
PSWD	The password for the BANUID.
SUBTIME	The submit time as specified on GJAPCTL. This parameter is not currently implemented.
TEMP	This is the prefix of the generated shl. It is constructed by the concatenation of the process name (\$1) and the one up number (\$5).
UIPW	The concatenation of BANUID/PSWD.

While the variables PRNT and FORM are made available to the procedure, only primitive print routing and special forms processing are addressed in the shell due to the vast variations in print managers. Customizing will probably be required to conform to the installation specific print programs.

The gjajobs.shl then invokes the generated shell to run the report or customized process as a background process. Control is then returned to the Banner on-line system and the user may continue work while the job executes.

Where possible, the system removes all intermediate and temporary files based on the assumption that jobs run without error in production. The deletion of these files reduces the need for frequent directory maintenance. Occasionally, the need may arise during implementation and training to preserve the intermediate and temporary files in order to monitor job summary statistics or possible process errors. In this case, you must modify `gjajobs.shl` so that it does not delete these files.

If you create any new processes of your own, make sure they are accessible through the path of the account used to submit GURJOBS.

umask Value for `gjajobs.shl`

Depending on how your environment is set up, you may wish to change the delivered `000` values set by `umask` for `gjajobs.shl` to make files more secure.

If `jobsub` and the users are in different groups you may need to use `umask 000`. If they are in the same group you could use `017`. If all reports are run to the database and server access is not required then you could use `077`.

To change the default permissions assigned to your UNIX files and directories, use the `umask` command. Its format is `umask nnn` where `nnn` is a three-digit code that defines the new default permissions.

Warning

Although they look similar, the `umask` string does *not* have the same format as the `chmod` permission string. ■

Each of the three numbers represents one of three categories: user, group, and other. The value for a category is calculated as follows:

- read (r) permission has a value of 4
- write (w) permission has a value of 2
- execute (x) permission has a value of 1

Sum the permissions you want to set for the category, then subtract that value from 7. As an example, examine the current default `umask` statement that is used to assign the file protections `-rwx-r-x---` :

```
umask 027
```

The user category value is 0 because $r + w + x = 4 + 2 + 1 = 7$. When this is subtracted from 7, the value is 0.

The group category value is 2 because $r + x = 4 + 1 = 5$. When this is subtracted from 7, the value is 2.

The other category value is 7 because no permissions = 0. When this is subtracted from 7, the value is 7.

For example:

```
umask 000      Set default to allow full access to everyone
touch test.000 Create file test.000 showing the resulting permissions
umask 017
touch test.017
umask 022
touch test.022
umask 027
touch test.027
umask 077
touch test.077 Allows access to only the owner
ls -l test.*   (execute access (x) does not display for non-executables)
-rw-rw-rw-    Jun 12 12:04 test.000
-rw-rw----    Jun 12 12:05 test.017
-rw-r--r--    Jun 12 12:05 test.022
-rw-r-----   Jun 12 12:05 test.027
-rw-----    Jun 12 12:05 test.077
```

It is important to note that files created by the jobsub process are not owned by the same user as the user for whom the process is being run. For example, if SAISUSR submits GLOLETT then glolett_12345.log and glotlett_12345.lis will be owned by the account running jobsub, *not* SAISUSR. If reports are run to the database and viewed by GJIREVO, then this may not be an issue. However, if the reports needs to be accessed on the server then this may be a concern.

To determine which group a user is in, use this command: `id <username>`

For example:

```
id user001
uid=6356(user001) gid=401(banner)
```

OpenVMS

gjajobs.com

OpenVMS command file called gjajobs.com is started by the system function. This command file interrogates the parameters passed to it and builds another temporary command procedure to actually run the report or procedure. The temporary command procedure consists of either the commands to execute (and print, based on a parameter from the GJAPCTL form) a report or commands to invoke a customized procedure for this job depending on the definition of the job in the GJBJOBS table.

The gjajobs.com then sets the following global symbols so they can be accessed by the submitted job if necessary.

For type E jobs

P1 This is the concatenation of P3, P4, P5 and P1 which correspond to the Username, User's Password, the one up number and the process name respectively.

For type P jobs

JOB This is P1, the process name.

TEMP The file name of the temporary command procedure. This is the concatenation of P1, followed by an underscore, followed by P5.

UID This is P3, the userid being used to run the job.

PSWD This is P4, the password for the UID.

SEQ This is P5, the one up number assigned at the time the job was submitted.

UIPW The concatenation of UID/PSWD.

PRNT This is P6, the name of the printer as specified on GJAPCTL.

FORM This is P7, the Special print options as specified on GJAPCTL.

SUBTIME This is P8, the submit time as specified on GJAPCTL. This parameter is not currently implemented.

PRNTOPT This symbol is built by the concatenation of P6 and P7.

For type C jobs

JOBTORUN This is the string \$GEN\$EXE: ' ' PROC ' .EXE where PROC has the value of P1, the process name.

JTR2 If the output file from the execution of the program is to be stored in the database, this string has the value \$GEN\$EXE:GURINSO.EXE.

While the variables PRNT and FORM are made available to the procedure, only basic print routing and special forms processing are addressed in the command procedure. Customization may be required to conform to the installation specific print requirements.

The gjajobs.com then submits the generated command procedure to run the report or customized process. Control is then returned to the Banner on-line system and the user may continue work while the job executes.

Where possible, the system removes all intermediate and temporary files based on the assumption that jobs run without error in production. The deletion of these files reduces the need for frequent directory maintenance. Occasionally, the need may arise during implementation and training to preserve the intermediate and temporary files in order to monitor job summary statistics or possible process errors. In this case, you must modify GJAJOBS.COM so that it does not delete these files.

If you create any new processes of your own, they must be put in a directory that is part of the logical BAN_COMS definition so they can be found by the job submission system.

You can view or print the job output on-line. You can also save the output to a local directory and manipulate it using external tools (for example, Excel or Word). The features of this change are detailed in two sections: How It Works, and How to Use It.

Windows Platform

Currently Windows NT and Windows 2000 are supported.

Several scripts are used in the submission of jobs on Windows. Additionally, job submission makes use of a perl module, `sctban.pm`, sometimes referred to as an include file, to perform many common tasks such as setting up the environment and printing output. All global subroutines contained in `sctban.pm` are prefixed by `sctban`, and all global variables set are prefixed by `sctban`. If you write any perl scripts of your own and wish to use the subroutines contained in `sctban.pm`, you must include a `use sctban` statement before using any of the common routines or runtime errors will result. This should be followed immediately with:

```
&sctban_determine_os;  
&sctban_os_specific_env;
```

For an example, please refer to the section that describes `gurjobs.pl`.

Initially, a perl script called `gjajobs.pl` is started by the system function call in GURJOBS. `gjajobs.pl` establishes an execution environment by calling the `sctban_os_specific_env` function. How the values for the variables are obtained is controlled by the `BANENV` environment variable. `BANENV` is set from the Control Panel -> System -> Environment tab. A value of *REG* for `BANENV` indicates to set variables based on their value in the System Registry. A value of *ENV* means to use the value currently assigned to the environment variable first, and, if not set, default the value from the registry.

Next, the following variables are established:

```
$sctban_process_name$ARGV[0]  
$sctban_process_type$ARGV[1]  
$sctban_user_id$ARGV[2]  
$sctban_password$ARGV[3]  
$sctban_oneup_number$ARGV[4]  
$sctban_printer_name$ARGV[5]
```



```
$sctban_form$ARGV[6]
$sctban_submit_time$ARGV[7]
```

Note

These are the arguments passed to `gjajobs.pl` as described above in the section on the GUQINTF form. ■

The `sctban_jsub_env` function is called to set additional environment variables followed by a call to `sctban_os_specific_jsub` to invoke `gjawnnts.pl`. This script opens up a background Windows process and calls `gjajsub.pl` which actually constructs the command to run the job based on `sctban_process_type`. Output from the execution is saved into temporary files which are assembled into a single file after the job is run. These files are put in the directory specified by `banner_jsub_home`. The naming convention is:

```
jobsub_home_sid_user_processname_oneupno
```

Job Submission Processing

The Job Submission Profile Maintenance Form (GJAJPRF) is used to maintain Operating System specific information for your user ID. The base table for the form is the Personal Preference Table (GURUPRF).

The Operating System is obtained from the `OPERATING_SYSTEM` property of the Oracle Forms built-in command `GET_APPLICATION_PROPERTY`. All entries shown on this form have an internal identification of `JOBSUB`, contained in the `GURUPRF_GROUP` column. The entries on the form identify in which sub process this transaction will be used. The Value has several meanings based on the value of the `JOBSUB` Component.

There are currently three `JOBSUB` components that can be manipulated using this form: `DEFAULT_PRINTER`, `LOCAL_DIRECTORY`, and `GURJOBS_DIRECTORY`. These three details will be stored with other personal user preferences on `GURUPRF`.

The `DEFAULT_PRINTER` and `LOCAL_DIRECTORY` are created automatically when you print and save (respectively) from the Job Submission Review Output Form (GJIREVO).

The `LOCAL_DIRECTORY` can be any directory name that you can write to from your PC.

TECHNICAL NOTE: The `GURJOBS` program provides two mechanisms to specify the location of output files generated from batch jobs. One technique involves looking up the username; the other allows for the specification of a directory name to be passed to `GURJOBS`.

Looking Up the User

For UNIX, this is done by reading the `/etc/passwd` file. If the `userid` is found in the file, the literal `jobsub` is appended to this directory, and, if the directory exists and is able to be written to, this directory is substituted for the `HOME` environment variable before the `HOST`

command is executed. If the directory does not exist, or it can not be written to, the current HOME directory is used when the job is run.

For OpenVMS, Banner looks up the user in the sysuaf.lis file. This file is generated by running the authorize facility:

1. Logon as the user *SYSTEM*
2. Change to the SYS\$SYSTEM directory by entering:

```
SET DEF SYS$SYSTEM
This should be the location of the sysuaf.dat file.
```

3. Run the authorize utility by entering:
RUN AUTHORIZE
The command prompt will change to UAF>
4. Generate the sysuaf.lis file by entering the word LIST.
UAF> LIST
5. To exit the authorize utility enter the word EXIT.
UAF> EXIT

The sysuaf.lis file will contain information about all logons for the machine. A sample follows.

<i>Owner</i>	<i>Username</i>	<i>UIC</i>	<i>Account</i>	<i>Priv</i>	<i>Pri</i>	<i>Directory</i>
Banner7	BANNER7	[522,0]	BANNER	All	4	\$DISK1:[BAN71_ROOT]

When GURJOBS looks up a user, it opens this file, so it must be copied to a directory that can be accessed by the GURJOBS program while it's running. Usually the sys\$login directory will suffice. Also make sure the privileges on the sysuaf.lis file are changed if needed so it can be opened by the userid used to submit GURJOBS.

Alternatively, you could change GURJOBS so that the location of the sysaf.lis file was fully-qualified.

If the userid is found, a temporary .com file is built and a set def to this directory is written to the file, followed by the HOST command. If the directory is not found, the HOST command is issued directly.

 **Note**

Your printer destination is controlled by your host login. ■

The DEFAULT_PRINTER must first be established on the GTVPRNT Form as a valid printer code.

The Printer Validation Form (GTVPRNT) allows the entry of landscape and portrait escape sequences for the printer. The Saved Output Review Form (GJIREVO) uses the information when a request is made to print the report. The **Printer Port** field is used to specify the name of a printer port used as the target of a copy operation when a request to print a report is made from the Saved Output Review Form (GJIREVO). For example, \\fs12\talaris2. The **Landscape Codes** field is used to record the escape sequence required to print in landscape format on the printer designated by the code. The **Portrait Codes** field is the same as the **Landscape Codes** except these are the sequences for portrait mode.

These are entered as a sequence of concatenated chr codes (e.g., chr(10)||chr(20)), which are then processed using DBSM_SQL to create the escape sequence necessary to inform the printer to switch to landscape print mode. This escape sequence is inserted as the first line of the output before being copied to the printer port specified in the previous field.

Pressing the Insert Record key will create the GURJOBS_DIRECTORY row. This preference is used to specify the name of a directory where output from Pro*C jobs will be placed when the job is run from the Process Submission Control Form (GJAPCTL).

Specifying a Home Directory

The GJAJPRF form may be used to specify the location of a *home* directory to be used when batch jobs are run. The GURJOBS_DIRECTORY preference indicates this, and is stored in the database table GURUPRF.

There are several ways to specify a value:

- If the record does not exist, select the create record key. The form will create a GURJOBS_DIRECTORY preference and attempt to find a home by sending a request to GURJOBS to lookup the username as described above. If found, a directory name is returned.
- You may also enter the name of a directory. (For example, a file system that gets exported and mounted to a PC.) This will then be sent to GURJOBS and an attempt will be made to create a test file in this location. If successful, the name will be accepted. If not, an error message will be issued.
- You can also enter the literal LOOKUP, which will send a request to GURJOBS to lookup the user as described above.
- You can enter the literal DATABASE. This option is valid for Pro*C programs and General COBOL programs, and will cause the output to be placed in the database. It can subsequently be reviewed on the GJIREVO form.

Note

The Insert Output Program (GURINSO) is a Pro*C program that is used to insert the output into the database if the literal DATABASE had been entered in the Printer field of the Process Submission Control Form (GJAPCTL). The gjajobs.sh/.com file invokes execution of the program. If

the program runs through the invocation of a command procedure, such as GLBDATA, the command procedure will invoke GURINSO. ■

The Saved Output Review Form (GJIREVO) provides the ability to save the output as a file in a directory and the ability to print the output if a network printer is available to the user (Windows PC only). When a request to print the output is made, the output is first saved to a local file and then printed by issuing a copy command to the printer port specified on the GTVPRNT form. You can also purge the output from the database using this form.

 **Note**

No attempt is made to delete the file from the LOCAL_DIRECTORY if a save or print operation was performed. ■

Using Job Submission

Before attempting to print any data with the Saved Output Review Form, check that a printer has been set up on the Printer Validation Form (GTVPRNT).

To produce the output, run a job in Job Submission as usual but be sure to put the word *DATABASE* in the **Printer** field of the Process Submission Control Form (GJAPCTL).

 **Note**

If you run multiple jobs with the same name, the system should not overwrite the existing output because Job Submission incorporates the job's one-up number as part of the generated file name. If you are running jobs of some other type that do not use the one-up number as part of the file name, you may overwrite an existing file. ■

To view and print the output you created, access the Saved Output Review Form (GJIREVO).

Enter a job name in the Job Name field or press the Job Name Button for a list of the jobs that were run under your user ID that have not been purged from the database. You can double-click to select the desired output.

Your output will immediately appear in the Saved Output block of the form for review. At this point you can select the **Save and Print** button to save your output to your local directory, as well as print a copy of the output to the printer you specify.

Select the **Save to File** button to save your output to the your local directory. Select the **Delete Output** button to remove the selected file from the database.

 **Note**

No attempt will be made to delete the file from your local directory once you have saved it. Local directory maintenance of files is up to the individual site using this procedure. ■

GURJOBS

GURJOBS is a PRO*C program created to handle the passing of jobs on a system network. It receives messages sent by the PIPEIT trigger in GUQINTF form, on a ORACLE PIPE named GURJOBS. When it receives a message, it must unpack it to determine what course of action to take. This is indicated by the first message which is the request type.

Currently, GURJOBS is designed to process three types of requests:

1. *HOST requests* - usually those originating from the GJAPCTL form. These jobs are submitted into the background (where available) and control is returned immediately to GUQINTF
2. *WAIT requests* - typically initiated from an application form. GLRVRBL is an example of a WAIT type. GURJOBS waits for the request to be fulfilled (if it can) before sending a response back
3. *EXIT requests* - terminate GURJOBS. The exit command is sent by signing on to SQL*Plus and starting the gurstop.sql file contained in the general/plus subdirectory

The second message unpacked is the HOST command built by the GUQINTF form.

The third message names a return pipe. The name of the return pipe is generated by executing the DBMS_PIPE.UNIQUE_SESSION_NAME function which returns a unique name based on the connection to the database, much like USERENV('SESSIONID').

The fourth message is optional and will only be present if a directory name has been established on the GJAJPRF form. If a directory name was not provided, GURJOBS will attempt to look it up by extracting the username from the command.

GURJOBS takes the unpacked message and issues the "system" function passing the host command as its argument.

```
system(command_string);
```

It then packs a message saying that the request is being processed and sends it back to the PIPEIT trigger. This message is relayed back to GJAPCTL, which displays it on the status line of the form. These messages are not usually displayed by application since they typically use the GJBRSALT table to indicate the status of the run.

When the system function is executed it will either execute the GJAJOBS file or the name of the file specified in the command name field on the GJAJOBS form.

Managing Job Submission on Windows

Starting Job Submission for your Default Database

To start the Job Submission Application Server (GURJOBS) program you will need to perform the following steps.

Prerequisites:

This assumes that you have your `ORACLE_SID` entry in the Oracle Registry set to your initial Banner install database, usually *SEED*.

This also assumes that your System Environment variable `BANENV` is set to *REG*. *REG* means that the initially installed Banner key will be used from the registry. To view and change the `BANENV` variable, select Control Panel > System>Environment.

To start GURJOBS:

1. Check the value of `ORACLE_SID` in the Oracle Registry.
2. Check the value of the System Environment variable `BANENV`.
3. Position in the `\general\misc` directory under Banner's Home directory.
4. Start the Perl script `gurjwnt.pl`. This will start job submission in the background. Note the space between the userid and the password.

```
perl gurjwnt.pl <uid> <passwd>
```

5. Bring up the NT task manager and verify that `gurjobs.exe` is running.

To keep job submission running on NT you must leave the administrator account logged in on the console. The console can be locked so that a password is needed to access it, but it is still logged in.

In the future, SunGard will publish instructions for how to run job submission as a service. This, however, will require some files from the NT resource kit.

Starting Job Submission for Multiple Databases

The below example assumes you will have a *SEED* and *TRNG* instance - case does NOT matter.

1. Change the `BANENV` setting to *ENV* (for ENVironment) in the System Environment. Select Control Panel>System>Environment to change this value. Changing `BANENV` to

be *ENV* will allow Banner to override a registry entry with a value from the environment.

2. Create a LOCAL directory (optional - this could all be done in the Banner directories). Copy the `general\misc\gurjwnt.pl` script into the LOCAL directory to a name of `gurjwnt_seed.pl`.
3. Edit the `gurjwnt_seed.pl` script and add a line following the line `&sctban_os_specific_env`; to set the `ORACLE_SID` for this instance as follows:

```
$ENV{"ORACLE_SID"} = "SEED";
```
4. Save and exit the script.
5. Run this script to start GURJOBS against the SEED database. Substitute your actual path for `c:\local\`.

```
perl -S c:\local\gurjwnt_seed.pl <uid> <pswd>
```

Do the same tasks for `GURJWNT_TRNG.PL`, substituting *TRNG* for *SEED*.

Viewing Job Submission Output

The output of a job may be viewed on the Saved Output Review Form (GJIREVO). When you select Options>Show Document (Save and Print File), the Job Submission Output is displayed in a browser window. The output can then be saved to a local file or printed.

To set up Banner to support this feature:

1. Create an Oracle Application Server Listener and PL/SQL cartridge, or use an existing one. An example URL might be:

```
http://yourserver.com:portnumber/prodban7/
```
2. In Banner, go to the General User Preferences Maintenance Form (GUAUPRF). Select the Directory Options button.
3. Scroll down until you find the **Description** that contains *Enter the name of your Web Output URL*.
The **Default Value** field contains `http://yourserver.com/directory`.
4. Enter your directory name in **User Value**.
5. Enter the URL you created in **User Value** and save your changes, for example:

`http://yourserver.com:portnumber/prodban7/`

 **Note**

If you want to change this value for all users, you must log onto Banner with the userid `BASELINE`, and then make the changes on `GUAUPRF`. ■

6. Logon to Banner in a web forms environment, and go to `GJIREVO`. The output of the job appears in a separate browser window. You can save the output to a file or send it to a printer by selecting the appropriate item from the Options menu.

Data Extract Process

You can extract data from a Banner form to use in a spreadsheet. For instructions and a list of supported forms, see “Extracting Banner Data to a Spreadsheet” in Chapter 3 of the *Banner Getting Started Guide*.

You can use the Object Maintenance Form (`GUAOBS`) to enable the extract feature on any form where the extract has been tested.

To set up Banner to support this feature, you must perform the following steps:

 **Note**

You may have already done these steps to establish support for processing with the Saved Output Review Form (`GJIREVO`). If so, you do not need to repeat them. ■

1. Create an Oracle Application Server Listener and PL/SQL cartridge, or use an existing one. An example URL might be:
`http://yourserver.com:portnumber/prodban7/`
2. In Banner, go to the General User Preferences Maintenance Form (`GUAUPRF`). Select the **Directory Options** button.
3. Scroll down until you find the **Description** that contains *Enter the name of your Web Output URL*.
4. Enter the URL you created in **User Value** and save your changes.

 **Note**

To use the URL you created for all users, you must be logged into Banner with the userid `BASELINE` when you make your changes on `GUAUPRF`. ■

Any records that were created by a data extract are deleted when the user leaves Banner. If a user’s data extracts result in a total of more than 500 records being selected, the following message will display when the user exits: *There may be a delay exiting caused by the removal of data extracted during this session.*

If a user has performed FGAGASB data extracts resulting in a total of more than 500 records being selected, the message on the user's exit will be *There may be a delay exiting caused by the removal of FGAGASB data extracted during this session.*

Data Extract Tables

With Release 7.4, two tables were introduced specifically for storing data extract information. The new tables are:

- Data Extract Collection Header Table (GUBOUTD)
- Data Extract Collection Detail Table (GUROUTD)

Prior to Release 7.4, data extract information was stored in Job Submission tables GUBOUTP and GUROUTP. Sharing these tables with Job Submission had the potential to cause performance problems, particularly during month-end, quarter-end, and year-end processing. Having separate tables dedicated to data extract improves performance during busy processing times.

Note

Data extracted using the Banner Finance GASB Parameter Form (FGAGASB), or accessed via the Saved Output Review Form (GJIREVO), are still stored in the GUBOUTP and GUROUTP tables. ■

Purging Data Extract Records with gdeloutd.sql

The gdeloutd.sql script is used to delete any GUBOUTD and GUROUTD records that are less than the input date (in *DD-MM-YYYY* format) provided by the user. Since the data stored in the new GUBOUTD and GUROUTD tables are temporary, and purged during logout from Banner, a problematic exit from Banner may cause the data to remain in the tables. In that case, you can use this script to manually remove the data.

Environment Variable BAN_DATA_EXTRACT_PAD_COLUMNS

This optional environment variable is used in conjunction with the GOQRPLS routines GOQRPLS.G\$_DATA_EXTRACT and GOQRPLS.G\$_WRITE_BLOCK.

- If the variable is set to *Y (Yes)*--The Data Extract logic in the G\$_WRITE_BLOCK will pad the columns with spaces, as it did before Release 7.4.
- If the variable is set to *N (No)*--The columns will not be padded with spaces. The padding is not needed because the columns have “wrapper” of double quotes around them.

Note

If the variable does not exist, then Banner assumes a value of *N*. ■



7 APIs



Application Programming Interfaces (APIs) are used to facilitate the integration of Banner with other applications on campus and simplify code by encapsulating business logic in database packages. An API is a central program that creates, updates, and deletes data. APIs also execute and validate business rules before inserting or updating information.

Detailed documentation for APIs can be downloaded from the Customer Support Center. Select “API Documentation” when browsing for product documentation. There is also an optional API/ERD Index (`api_erd_index_guide.zip`) that provides a single starting point for HTML-based API documentation and Entity Relationship Diagrams.

APIs Used in Banner General

The following tables and forms use APIs to process data in Banner General. The form listed next to the table in this chart is the representative source used to build the API validation and business rules. The APIs replace the corresponding code in the Banner forms.

Most of the APIs support create, update, and delete signatures. Exceptions, such as queries, are noted under Task Performed.

Table	Form	API Object Name	API Entity Name	Task Performed
GORFGBP	GOAFGAC	gb_bus_prof_rule	BUSINESS PROFILE RULE	Assigns the categories of users and their privileges to each domain and predicate for a FGAC VBS Group Rule
GORFBPR	GOAFBPR	gb_businessprofile	BUSINESS PROFILE	Groups users with similar responsibilities for FGAC VBS processing
GORFBPI	GOAFBPI	gb_busprofpii	BUSINESS PROFILE PII	Groups users with similar responsibilities for FGAC PII processing

Table	Form	API Object Name	API Entity Name	Task Performed
GORCMDD	GORCMDD	gb_cm_data_dictionary	COMMON MATCHING DATA DICTIONARY	Maintains data dictionary entries for common matching
GORCMDH	GORCMDH	gb_cm_disp_hier	COMMON MATCHING DISPLAY HIERARCHY	Maintains display hierarchy information for common matching.
GORCMD0	GORCMRL	gb_cm_display_options	COMMON MATCHING DISPLAY OPTIONS	Maintains options for how common matching search results will be displayed
GORCMSR	GORCMRL	gb_cm_rules	COMMON MATCHING RULES	Maintains common matching rules
GORCMSP	GORCMRL	gb_cm_source_priority	COMMON MATCHING SOURCE PRIORITY	Maintains priority numbers for common matching source codes
GORCMSC	GORCMSC	gb_cm_source_rules	COMMON MATCHING SOURCE RULES	Maintains source codes for common matching
GORCMUP	GORCMRL	gb_cm_user_procedure	COMMON MATCHING USER PROCEDURE	Associates packaged procedures to be used by the common matching procedure
GOBCMUS	GORCMUS	gb_cm_user_setup	COMMON MATCHING USER SETUP	Maintains users for common matching
GTVCURR	GTVCURR	gb_currency	CURRENCY	Maintains currency codes
GURCURR	GUACURR	gb_currency_rate	CURRENCY RATE	Maintains rates for currency conversion
GORDMCL	GORDMCL	gb_displaycolumns	DISPLAY COLUMN	Maintains data items (columns) for Protection of Sensitive Information security
GORDMSK	GORDMSK	gb_displaymask	DISPLAY MASK COLUMN RULE	Maintains rules for users and items (columns) for Protection of Sensitive Information security

Table	Form	API Object Name	API Entity Name	Task Performed
GOBFDMN	GORFDMN	gb_domains	DOMAIN	Maintains domains for FGAC processing
GOBFDTP	GORFDTP	gb_domaintype	DOMAIN TYPE	Maintains domain types for FGAC processing
GOREMAL	GOAEMAL	gb_email	EMAIL	Maintains e-mail address records
GORFGUS	GOAFGAC	gb_fgac_user_rule	FGAC USER RULE	Assigns users and their privileges to each domain-predicate combination for a FGAC VBS Group Rule
GOBFEOB	GORFEOB	gb_fgacexcluded-objects	FGAC EXCLUDED OBJECT	Maintains objects excluded from all FGAC processing
GOBFGAC	GOAFGAC	gb_group_rules	GROUP RULE	Maintains the Active and Effective Date characteristics for FGAC VBS group rules
GORIMMU	GORIMMU	gb_immunization	IMMUNIZATION	Maintains immunization status information
GORIROL	—	gb_institution_role	INSTITUTION ROLE	Calculates institutional roles
GORICCR	GORICCR	gb_integ_config	INTEGRATION CONFIGURATION	Maintains integration configuration settings
GORBLOB	TGISTMT	gb_large_object	LARGE OBJECT	Provides centralized storage for large objects, including graphics files and PDFs.
GORNAME	GORNAME	gb_name_translate	NAME TRANSLATE	Maintains aliases or nicknames associated to given names (No update)
GORNPNM	—	gb_np_name_trans	NP NAME TRANS	Maintains aliases or nicknames associated with non-person names.
GORPRAC	GOQCLIB	gb_person_race	PERSON RACE	Maintains person race data

Table	Form	API Object Name	API Entity Name	Task Performed
GORFDPI	GORFDPI	gb_pii_tables	PII TABLE	Maintains table rules for FGAC PII processing
GORINTG	GORINTG	gb_partner_rule	PARTNER RULE	Maintains integration partner system rules.
GOBANSR	GOATPAD	gb_pin_answer	PIN ANSWER	Stores answers to security questions and compares the answers provided by users during the PIN reset process.
GOBQSTN	GOAQSTN	gb_pin_question	PIN QUESTION	Stores and retrieves security questions used in the PIN reset process.
GORADID	%IDEN forms	gb_additional_ident	ADDITIONAL IDENT	Stores and retrieves additional ID information.
GORRACE	GORRACE	gb_race_ethnicity	RACE ETHNICITY	Maintains race rule information
GORSDDV	GOADISC	gb_sde_discrim_value	DISCRIM VALUE	Stores and retrieves discriminator values for SDE processing.
GOBSDDC	GOADISC	gb_sde_discriminator	SDE DISCRIMINATOR	Stores and retrieves discriminator information for SDE processing.
GORSDAM	GOASDMD	gb_sde_metadata	SDE METADATA	Stores and retrieves metadata for SDE attributes.
GOBSDTB		gb_sde_table	SDE TABLE	Stores and retrieves information on Banner tables that have been extended with supplemental data through SDE.
GOBT PAC	GOATPAC	gb_third_party_access	THIRD PARTY ACCESS	Maintains cross-references between third party system user IDs and Oracle user ID (No delete)

Table	Form	API Object Name	API Entity Name	Task Performed
GOBFPUD	GOAFPUD	gb_userdefault	USER DEFAULT	Defines a user's home domain for FGAC PII processing
GORFPPII	GOAFPPII	gb_userpiidomains	USER PII DOMAIN	Maintains domains for each user for FGAC PII processing
GORFPRD	GORFDTP	gb_vbs_predicate	VBS PREDICATE	Maintains predicate statement (WHERE clause) for FGAC VBS processing
GORFDPL	GORFDPL	gb_vbs_tables	VBS TABLE	Maintains tables associated with each domain for FGAC VBS processing
GORVISA	GOAINTL	gb_visa	VISA	Maintains visa codes.

APIs Used in Banner General with Student Forms and Tables

The following Student tables and forms use APIs to process data in Banner General and Banner Student.

Table	Form	API Object Name	API Entity Name	Task Performed
SPRADDR	SPAIDEN	gb_address	ADDRESS	Maintains address information
SPBPERS	SPAPERS	gb_bio	BIO	Maintains biographic/demographic information for an individual
SLBBLDG	SLABLDG	gb_bldgdefinition	BLDGDEFINITION	Maintains building information
SSRMEET	SSASECT	gb_classtimes	CLASSTIMES	Maintains section and event meeting times
SPREMRG	SPAEMRG	gb_emergency_contact	EMERGENCY CONTACT	Maintains emergency contact information for an individual

Table	Form	API Object Name	API Entity Name	Task Performed
SPRHOLD	SOAHOLD	gb_hold	HOLD	Places or removes holds on an account
SPRIDEN	SPAIDEN	gb_identification	IDENTIFICATION	Maintains person and non-person biographic/demographic information
–	–	gp_international_student	INTERNATIONAL STUDENT	Retrieves international student information from fsaATLAS.
SPRMEDI	SPRMEDI	gb_medical	MEDICAL CODE	Maintains information about medical conditions.
SORPCOL	SOAPCOL	gb_prior_college	PRIOR COLLEGE	Maintains a person's educational background information.
SORCONC	SOAPCOL	gb_pcol_concentration	PRIOR COLLEGE CONCENTRATION	Maintains educational background information on areas of concentration.
SORDEGR	SOAPCOL	gb_pcol_degree	PRIOR COLLEGE DEGREE	Maintains educational background information on degrees.
SORMAJR	SOAPCOL	gb_pcol_major	PRIOR COLLEGE MAJOR	Maintains educational background information on majors
SORMINR	SOAPCOL	gb_pcol_minor	PRIOR COLLEGE MINOR	Maintains educational background information on minors
SLRRASG	SLARASG	gb_roomassignment	ROOMASSIGNMENT	Maintains dorm room assignments
SLBRDEF	SLARDEF	gb_roomdefinition	ROOMDEFINITION	Maintains room information by building
STVTERM	STVTERM	gb_stvterm	STVTERM	Queries term validation information
SPRTELE	SPATELE	gb_telephone	TELEPHONE	Maintains telephone information
		gp_cardholder		Process APIs related to campus card cardholders

Table	Form	API Object Name	API Entity Name	Task Performed
		gp_common_matching		Checks for the existence of a record within the Banner System based on criteria (rules) defined for the source of the data
		gp_entity_address		Process API to add or update address information about a person in the Banner system
		gp_international_student		Process API to retrieve International Student Information
		gp_person_identity		Process API to allow external systems to determine the unique identifier (ID number) for a person.

APIs for Internal Banner Operations

Please be advised that several Banner General APIs are currently intended only to support internal operations.

To ensure data integrity, these APIs are not supported when called by external applications or interfaces to manipulate data. The recommendation for external applications is to use message level integration to integrate with these entities in Banner.

The following APIs come under this disclaimer:

gb_advq_util	gb_gtvdicd	gb_gtveqpg
gb_common	gb_gtvdiro	gb_gtveqpm
gb_event	gb_gtvdocm	gb_gtveqts
gb_gtvcall	gb_gtvdprp	gb_gtvexpn
gb_gtvccrd	gb_gtvdstp	gb_gtvfbpr
gb_gtvcelg	gb_gtvdund	gb_gtvfdmn
gb_gtvcmisc	gb_gtvemal	gb_gtvfdtp
gb_gtvcurr	gb_gtvemph	gb_gtvfees
gb_gtvdadd	gb_gtveqnm	

gb_gtvfgac	gb_gtvsvap	gb_stvcomf
gb_gtvfst	gb_gtvsvba	gb_stvcoms
gb_gtvftyp	gb_gtvsvca	gb_stvcomt
gb_gtvfunc	gb_gtvsvcc	gb_stvdays
gb_gtvimmu	gb_gtvsvcp	gb_stvdegc
gb_gtvimst	gb_gtvsvcr	gb_stvdept
gb_gtvinsm	gb_gtvsvdt	gb_stvdisa
gb_gtvletr	gb_gtvsvel	gb_stvempt
gb_gtvlfst	gb_gtvsvep	gb_stvethn
gb_gtvmail	gb_gtvsvft	gb_stvetyp
gb_gtvmenu	gb_gtvsvgo	gb_stvfcnt
gb_gtvmtyp	gb_gtvsvio	gb_stvgeod
gb_gtvntyp	gb_gtvsvit	gb_stvgeor
gb_gtvobjt	gb_gtvsvpc	gb_stvhldd
gb_gtvpara	gb_gtvsvrp	gb_stvlang
gb_gtvpars	gb_gtvsvtr	gb_stvlead
gb_gtvmdir	gb_gtvsvts	gb_stvlevl
gb_gtvprnt	gb_gtvsvts	gb_stvlgy
gb_gtvproc	gb_gtvsvts	gb_stvmajr
gb_gtvptyp	gb_gtvsvts	gb_stvmatl
gb_gtvpurp	gb_gtvsvts	gb_stvmdeq
gb_gtvrate	gb_gtvsvts	gb_stvmrtl
gb_gtvrevn	gb_gtvsvts	gb_stvnatn
gb_gtvrrac	gb_gtvsvts	gb_stvorig
gb_gtvrsvp	gb_gtvsvts	gb_stvprcd
gb_gtvrtng	gb_gtvsvts	gb_stvptyp
gb_gtvrschs	gb_gtvsvts	gb_stvrdef
gb_gtvscod	gb_gtvsvts	gb_stvrelg
gb_gtvsdax	gb_gtvsvts	gb_stvrelt
gb_gtvdiv	gb_gtvsvts	gb_stvrms
gb_gtvsegc	gb_gtvsvts	gb_stvracd
gb_gtvsqpa	gb_gtvsvts	gb_stvsbgi
gb_gtvsqpr	gb_gtvsvts	gb_stvsite
gb_gtvsqru	gb_gtvsvts	gb_stvspon
gb_gtvsrce	gb_gtvsvts	gb_stvspsr
gb_gtvssfx	gb_gtvsvts	gb_stvstat
gb_gtvsubj	gb_gtvsvts	gb_stvsubj
		gb_stvtele
		gb_stvtrmt
		gb_xml_generator

8 Interfaces



Interfaces with External User Systems

GOKSVEX Package

This package is the interface between the SEVIS Transfer Adapter (SEVISTA) and Banner. It contains functions and procedures that select, update, insert, and delete data from the GORSVBH and GOTSVBT tables. The package is executed externally by SEVISTA.

This package can also create a comma-separated value (CSV file) that can be imported into the fsaATLAS application by the fsaATLAS Campus DataLink.

GORSVBH Table

This table contains the header information for SEVIS batch transaction records. The SEVISTA external tool uses this table.

GOTSVBT Table

This table contains detail records for SEVIS batch transaction records. The SEVISTA external tool uses this table.

GURFEED Table

This table contains financial transactions from Banner applications which are to be processed by the client's Accounting system via a user interface program.

GURAPAY Table

This table contains single line invoices from Banner applications which are to be processed by the client's Accounts Payable system via a user interface program.

Interfaces within Banner

GURFEED Table

This table contains financial transactions from other Banner applications or client-developed applications which are to be processed into Banner Finance using the FURFEED and FGRTRNI processes.

GURAPAY Table

This table contains single line invoices from other Banner applications or client-developed applications, which are to be processed into Banner using the FURAPAY process.



Form Generation

Mass Form Generation Scripts

The following mass form generation scripts generate a single product's forms objects. The scripts are located in the appropriate product /misc or /com production directory.



Warning

Make sure you compile your forms in the Forms Compiler. You may receive unpredictable results if you compile them in Forms Builder. ■

Product	Forms Windows	Forms UNIX	Oracle Reports Windows	Oracle Reports UNIX
Accounts Receivable	tasform.bat, tasformr2.bat	tasform.shl, tasformr2.shl	tasrept.bat, tasreptr2.bat	tasrept.shl, tasreptr2.shl
Advancement	aluform.bat, aluformr2.bat	aluform.shl, aluformr2.shl		
Financial Aid	resform.bat, resformr2.bat	resform.shl, resformr2.shl		
Finance	fimform.bat, fimformr2.bat	fimform.shl, fimformr2.shl	fimrept.bat, fimreptr2.bat	fimrept.shl, fimreptr2.shl
General	genform.bat, genformr2.bat, genform1.bat, genform1r2.bat, genform2.bat, genform2r2.bat, comform.bat, comformr2.bat	genform.shl, genformr2.shl, comform.shl, comformr2.shl		
Payroll Module	payform.bat, payformr2.bat	payform.shl, payformr2.shl		

Product	Forms Windows	Forms UNIX	Oracle Reports Windows	Oracle Reports UNIX
Position Control	posform.bat, posformr2.bat	posform.shl, posformr2.shl		
Student	stuform.bat, stuformr2.bat	stuform.shl, stuformr2.shl	sturept.bat, stureptr2.bat	sturept.shl, stureptr2.shl
BDMS	extform.bat, extformr2.bat	extform.shl, extformr2.shl		

Generating and Compiling

Follow the instructions included in the above scripts to mass generate Banner forms. Review the documentation inside the specific script that you are about to execute.

COBOL Compiling

This section provides general information about the COBOL compilation process, such as required directories, file locations, and example scripts.

Banner compile scripts are provided for new installations and upgrades to compile all code in the correct order. On UNIX and OpenVMS machines the output from the compile will be placed by default in the `exe` subdirectory of the General product. If the compile routines for your port or site write into the current directory, then the output from the compiles will have to be migrated before they can be accessed by the users.

Note

If your compile procedure writes directly into the General product's `exe` subdirectory, this procedure must be run from an operating system account that has write permission into the target Banner directories. ■

Compiling COBOL under UNIX

Compiling COBOL code under the UNIX operating system is accomplished through the use of the `make` command, a special-purpose scripting language usually provided as part of the UNIX language development environment. A makefile is needed for all but the most basic make operations; it specifies the actions to be taken to perform particular tasks, such as making an executable from a COBOL source file, or building an object file from a Pro*COBOL file.

To compile Banner Pro*COBOL code into executables, you must create a makefile that includes all of the proper options and libraries for the combination of operating system, Oracle, and compiler versions installed on your machine.

Creating a Pro*COBOL Makefile

The `buildcob` process is provided as a tool to assist Banner clients using UNIX systems in constructing a valid Pro*COBOL makefile for their particular operating system, Oracle, and compiler environment. Two files are provided: `buildcob.c` (source code for `buildcob`) and `bancob.tpl` (a Banner makefile template.)

To use `buildcob`, follow these steps:

1. Log in as your Banner owner.
2. Make sure that your environment reflects the proper `ORACLE_HOME`. This is necessary because the `buildcob` process uses an Oracle demo makefile as a model and must be able to find it.
3. Enter the following:

```
cd $BANNER_HOME/install
```
4. Compile the `buildcob.c` file with an ANSI-compliant C compiler. Some compilers require command-line parameters to recognize ANSI code; refer to your compiler documentation for details.

Example: `cc buildcob.c -o buildcob`

5. Execute `buildcob` and respond to the on-screen messages and prompts.

Note

The value for your COBOL compiler may differ from the default. ■

6. You should now have a makefile with the default name of `sctprocb.mk` in the `$BANNER_HOME/general/cob` directory. Use this makefile to compile a Banner Pro*COBOL program, and make changes to `sctprocb.mk` to resolve any errors. Sequent, NCR, and DEC Ultrix machines require that `COMP5=YES` be passed to the pre-compiler for byte storage compatibility. Other platforms may require that this be commented out.

If you find that your local environment requires changes from the defaults, you may directly edit the provided `bancob.tpl` file so that your changes are preserved when you rerun the `buildcob` process in the future.

Example `buildcob` Session

The following is an example dialog from a run of the `buildcob` process under the Digital UNIX operating system:

```
% cc buildcob.c -o buildcob
% buildcob
```

`buildcob` is a program that assists in the creation of a Banner Pro*COBOL makefile. Using a SunGard-provided template and an Oracle makefile from your current release of the Oracle software, `buildcob` generates a new makefile that should work with your operating system and Pro*COBOL release.

 **Note**

The generated makefile also includes comments to guide you in making manual changes if necessary. ■

You will now be prompted for information needed by the `buildcob` program. The default value for each option appears in parentheses after the prompt; if you wish to accept the default for a particular option just hit enter. Each of these defaults is defined in a macro in the `buildcob` source code, making the setting of local defaults simple; comments in the source code explain the process.

Enter the name of your COBOL compiler; if your compiler is not present in your path, then you will need to specify a full directory reference.

```
e.g., /usr/local/cob
COBOL Compiler? ( cob )
```

Enter the name of the template file to be used to generate your new makefile. If you make local modifications to the SunGard-provided template then you may wish to copy the template to a different name and enter that name below.

```
SCT makefile template? ( bancob.tpl )
```

Enter the name of the model Oracle makefile. Oracle provides an example Pro*COBOL makefile that is used to make example programs and the Pro*COBOL executable itself; this file is scanned by `buildcob` to extract the proper library definitions for your system.

```
Oracle makefile model? ( /u02/app/oracle/product/9.2.0
/precomp/demo/procob/procob.mk )
```

Enter the name of the new makefile that `buildcob` will generate; if a file by that name already exists it will be overwritten.

```
New makefile to create? ( /yy/banner/general/cob
/sctprocb.mk )

bancob.tpl/yy/banner/general/cob/sctprocb.mkbuildcob
terminated normally Using sctprocb.mk
```

To use the `sctprocb.mk` makefile, position yourself to the directory containing the source code to be compiled, and enter a make command specifying both the makefile and the file to be generated.

```
make -f $BANNER_HOME/general/cob/sctprocb.mk PHPFEXP
```

Refer to your operating system documentation for further details on makefile construction and usage.

Reducing Executable Sizes

Pro*COBOL executables may be extremely large on some UNIX platforms, with implications for both runtime performance and storage requirements. To reduce the size of executables, you may choose to use the Oracle Run Time System (rtsora) and compile your Pro*COBOL code to .gnt files, or you may use shared objects to provide dynamic linking at runtime.

Note

One, both, or neither of these methods may be available on your particular platform; refer to your Oracle and operating system documentation for further information. ■

To use the Oracle Run Time System, you must build an `rtsora` executable in your `$ORACLE_HOME/bin` directory using an Oracle-provided procedure. Banner supports the Oracle Run Time System by using two environment variables, `COBPREF` and `COBSUFEX`, in all shell scripts that execute COBOL programs. These variables are created in `cbanenv` and `banenv` with null values; if you are using .gnt files, then `COBPREF` should be set to `rtsora` and `COBSUFEX` to `.gnt`. The other alternative is to use dynamic linking, or shared objects. If your operating system and Oracle release support this option, then modify your copy of `sctprocb.mk` and add `-lclntsh` at the beginning of the `LLIBS` macro definition.

Example:

```
LLIBS=-lclntsh $(COBSQLINTF) $(LLIBSQL) $(TTLIBS)
```

Also, the environment variable `LD_LIBRARY_PATH` will need to be defined in order for the shared object references to be resolved at runtime.

Example:

```
LD_LIBRARY_PATH=/usr/lib/cob/coblib:/u02/app/oracle  
product/9.2.0/lib export LD_LIBRARY_PATH
```

Stripping your executables of debugging information may also significantly decrease their size; this can usually be done at compile time with the `-s` switch to the compiler, or later with the stand-alone `strip` program. Also, if you are using certain versions of SVR4-based operating systems (such as Dynix/ptx), the `mcs-d` command can be used to strip internal comments from the executables.

Compiling COBOL under OpenVMS

All Banner Pro*COBOL compiles under OpenVMS use the command file `sctprocb.com`, located in the General product's `com` subdirectory. This command file executes the Oracle precompile, COBOL compile and link steps. In particular, the link step is performed by the Oracle-provided command file `lnprocob.com`, making `sctprocb.com` generally independent of Oracle releases.

Executing sctprocb with no arguments will provide usage notes similar to the following:

```
USAGE: @gen$com:sctprocb <program> [options]
OPTIONS:
-0 generates object only
-L generates the complete listing
-D compiles in debug mode
-C generates and saves .COB from the precompile
-S stop after executing pre-compiler
```

In addition, if a full parse of the source code is necessary, you must set the symbol CHECKOPT with an appropriate value before executing sctprocb.

Example:

```
$ CHECKOPT="sqlcheck=full userid=baninst1/u_pick_it"
```

Initial Installation

Instructions for doing a complete compile of all Pro*COBOL programs appear in the *Banner Initial Install Guide*. The information in this section is intended to provide complete instructions for and context of COBOL compiling. The steps outlined in this section should have already been performed at your site.

COBOL Compiling During Banner Installation

For an initial installation of Banner, all products that have COBOL programs need to have them compiled. The Banner installation process uses the script banccob.shl on UNIX or banccob.com on OpenVMS to compile all COBOL code.

You may use the .shl (UNIX), .com (OpenVMS), or .pl (Windows) versions of the scripts below to compile a single product's COBOL code. The scripts are located in the appropriate product's /misc or /com production directory.

Banner Product COBOL Compile Procedures

<i>Banner Product</i>	<i>Compile Procedures</i>
A/R Module	tascmpl
Advancement	none
Finance	none
Financial Aid	rescmplx
General	gencmpl
INAS (where x equals the last digit of the aid year)	rescmplx
Payroll Module	paycmpl
Student	stucmpl

Executables are built in the `$BANNER_HOME/general/exe` directory. This directory must be in the `PATH` of each Banner user.

UNIX

Below is a sample of the Banner General COBOL compile shell script.

```
# gencmpl.shl
#
cd $BANNER_LINKS
#
make -f $BANNER_LINKS/sctprocb.mk GUAGETP.o
make -f $BANNER_LINKS/sctprocb.mk GUASETR.o \
CHECKOPT="sqlcheck=full userid=baninst1/u_pick_it"
make -f $BANNER_LINKS/sctprocb.mk GUAVERFY \
BANOBJ=$BANNER_HOME/general/exe/GUAGETP.o
make -f $BANNER_LINKS/sctprocb.mk GLOLETT \
BANOBJ=$BANNER_HOME/general/exe/GUAGETP.o
make -f $BANNER_LINKS/sctprocb.mk GLBPARM \
BANOBJ=$BANNER_HOME/general/exe/GUAGETP.o
make -f $BANNER_LINKS/sctprocb.mk GLBDATA \
BANOBJ=$BANNER_HOME/general/exe/GUAGETP.o
make -f $BANNER_LINKS/sctprocb.mk GLBLSEL \
BANOBJ=$BANNER_HOME/general/exe/GUAGETP.o
```

OpenVMS

Below is a sample of the Banner General COBOL compile command script.

```
$! GENCMPL.COM
$! Command procedure to drive compilation of GENERAL Cobol programs.
$!
$ CHECKOPT="sqlcheck=full userid=baninst1/u_pick_it"
$!
$ @gen$com:sctprocb gen$pco:glolett
```

Windows

Below is a sample of the Banner General COBOL compile command script.

```
use sctcomp;
$sctcomp_product_dir = "general";
$sctcomp_input_file_ref = \*DATA;
&sctcomp_cobol_process;
__END__
GUAGETP.pco -exetype=obj
GUASETR.pco -exetype=obj -checkopt=full
```

GUAVRFY.pco
GLOLETT.pco
GLBPARM.pco
GLBDATA.pco
GLBLSEL.pco

C Compiling

This section provides general information about the C compilation process, such as necessary directories, file locations, and example scripts.

Banner compile scripts are provided for new installations and upgrades to compile all code in the correct order. On UNIX and OpenVMS machines the output from the compile will be placed by default in the `exe` subdirectory of the General product. If the compile routines for your port or site write into the current directory, the output from the compiles will have to be migrated before they can be accessed by the users.

Note

If your compile procedure writes directly into the General product's `exe` subdirectory, this procedure must be run from an operating system account that has write permission into the target Banner directories. ■

Compiling C under UNIX

Compiling C code under the UNIX operating system is accomplished through the use of the `make` command, a special-purpose scripting language usually provided as part of the UNIX language development environment. A makefile is needed for all but the most basic make operations; it specifies the actions to be taken to perform particular tasks, such as making an executable from a C source file, or building an object file from a Pro*C file.

To compile Banner Pro*C code into executables, you must create a makefile that includes all of the proper options and libraries for the combination of operating system, Oracle and compiler versions installed on your machine.

Creating a Pro*C Makefile

The `buildmk` process is provided as a tool to assist Banner clients using UNIX systems in constructing a valid Pro*C makefile for their particular operating system, Oracle, and compiler environment. Two files are provided: `buildmk.c` (source code for `buildmk`) and `banc.tpl` (a Banner makefile template.)

To use `buildmk`, follow these steps:

1. Log in as your Banner owner.
2. Make sure that your environment reflects the proper `ORACLE_HOME`. This is necessary because the `buildmk` process uses an Oracle demo makefile as a model and must be able to find it.
3. Enter the following:

```
cd $BANNER_HOME/install
```
4. Compile the `buildmk.c` file with an ANSI-compliant C compiler. Some compilers require command-line parameters to recognize ANSI code; refer to your compiler documentation for details.

```
cc buildmk.c -o buildmk
```
5. Execute `buildmk` and respond to the on-screen messages and prompts.

 **Note**

The value for your C compiler may differ from the default. ■

6. You should now have a makefile with the default name of `sctproc.mk` in the `$BANNER_HOME/general/cob` directory. Use this makefile to compile a Banner Pro*C program, and make changes to `sctproc.mk` to resolve any errors.

If you find that your local environment requires changes from the defaults, you may directly edit the provided `banc.tpl` file so that your changes are preserved when you rerun the `buildmk` process in the future.

Example `buildmk` Session

 **Note**

This is a tool. It is not guaranteed to produce a working makefile. ■

The following is an example dialog from a run of the `buildmk` process under the Digital UNIX operating system:

```
$ cc buildmk.c -o buildmk
$ buildmk
```

The program, `buildmk`, assists in the creation of a Banner Pro*C makefile. Using a SunGard-provided template and an Oracle makefile from your current release of the Oracle software, `buildmk` generates a new makefile that should work with your operating system and Pro*C release.

 **Note**

The generated makefile also includes comments to guide you in making manual changes if necessary. ■

You will now be prompted for information needed by the `buildmk` program. The default value for each option appears in parentheses after the prompt; if you wish to accept the default for a particular option, press the Enter key. Each of these defaults is defined in a macro in the `buildmk` source code, making the setting of local defaults simple; comments in the source code explain the process.

Enter the name of your C compiler; if your compiler is not present in your path, then you will need to specify a full directory reference.

```
e.g., /usr/opt/local/gcc  
C Compiler? ( cc )
```

Enter the name of the template file to be used to generate your new makefile. If you make local modifications to the SunGard-provided template then you may wish to copy the template to a different name and enter that name below.

```
SCT makefile template? ( banc.tpl )
```

Enter the name of the model Oracle makefile. Oracle provides an example Pro*C makefile that is used to make example programs and the Pro*C executable itself; this file is scanned by `buildmk` to extract the proper library definitions for your system.

```
Oracle makefile model? ( /u02/app/oracle/product/9.2.0  
precomp/demo/proc/proc.mk )
```

Enter the name of the new makefile that `buildmk` will generate; if a file by that name already exists it will be overwritten.

```
New makefile to create? ( /yy/banner/general/c  
/sctproc.mk)  
banc.tpl  
/yy/banner/general/c/sctproc.mk  
buildmk terminated normally
```

Using `sctproc.mk`

To use the `sctproc.mk` makefile, go to the directory containing the source code to be compiled, and enter a make command specifying both the makefile and the file to be generated.

Example:

```
make -f $BANNER_HOME/general/c/sctproc.mk gurtabl
```

Refer to your operating system documentation for further details on makefile construction and usage.

Added Switch for `sctproc.mk` File

With Release 7.2, a manual change must be made to your site-specific `sctproc.mk` file. This change is necessary whether your site is using Oracle 9i or 10g.

Under Oracle 10g, 10.1.0.2, and 10.1.0.3, there is an Oracle issue that causes the Pro*C precompile to not recognize nested SQL INCLUDE statements. The `guaorac.c` file, used by every Banner Pro*C program, was modified for Release 7.2 to use the standard precompiler `#include` directive to include the `oraca.h` and `sqlca.h` files as a workaround for the defect. Because of this change, the manual change to `sctproc.mk` is necessary. In `sctproc.mk` you must specify an additional `-I` switch for the `CFLAGS` macro to include the `$ORACLE_HOME/precomp/public` directory. For example:

```
CFLAGS=-I. \
    -I$(GINC) \
    -I$(ORACLE_HOME)/precomp/public \
    -O $(ANSI) $(STRIP) $(CCHECK) $(ENV) \
    $(SCT_DEBUG) $(OTHER_C_FLAGS)
```

Reducing Executable Sizes

Pro*C executables may be extremely large on some UNIX platforms, with implications for both runtime performance and storage requirements. To reduce the size of executables, you may be able to use shared objects to provide dynamic linking at runtime. Refer to your Oracle and operating system documentation for further information.

If your operating system and Oracle release support dynamic linking, also known as shared objects, then modify your copy of `sctproc.mk` and add `-lclntsh` at the beginning of the `LLIBS` macro definition.

Example:

```
LLIBS=-lclntsh $(PROLDLIBS)
```

Also, the environment variable `LD_LIBRARY_PATH` will need to be defined in order for the shared object references to be resolved at runtime.

Example:

```
LD_LIBRARY_PATH=/u02/app/oracle/product/9.2.0/libexport
LD_LIBRARY_PATH
```

Stripping your executables of debugging information may also significantly decrease their size; this can usually be done at compile time with the `-s` switch to the compiler, or later with the stand-alone strip program. Also, if you are using certain versions of SVR4-based operating systems (such as Dynix/ptx), the `mcs-d` command can be used to strip internal comments from the executables.

Compiling C under OpenVMS

All Banner Pro*C compiles under OpenVMS use the command file `sctproc.com`, located in the General product's `com` subdirectory. This command file executes the Oracle precompile, COBOL compile and link steps. In particular, the link step is performed by the Oracle-provided command file `lnproc.com`, making `sctproc.com` generally independent of Oracle releases.

Usage for `sctproc.com` is as follows:

```
USAGE: @gen$com:sctproc file_name [obj] [sqlcheck_option] [defines]
@gen$com:sctproc genobjs userid/password
OPTIONS: obj - compile to object only sqlcheck_option - one of:
none
syntax
limited
"full userid=name/password"
"semantics userid=name/password"
defines - other definitions to be passed to the compiler, e.g
(no_sleep_sw.opsys_vms) genobjs - to compile the General support
objects
```

Initial Installation

Instructions for doing a complete compile of all Pro*C programs appear in the *Banner Initial Install Guide*. The information in this section is intended to provide complete instructions for and context of C compiling. The steps outlined in this section should have already been performed at your site.

C Compiling During Banner Installation

For an initial installation of Banner, all products that have C programs need to have them compiled. The Banner installation process uses the script `bance.shl` on UNIX or `bance.com` on OpenVMS to compile all C code.

You may use the `.shl` (UNIX), `.com` (OpenVMS), or `.pl` (Windows) versions of the scripts below to compile a single product's C code. This step may execute for several hours depending on your machine speed and how many Banner products you are installing. The scripts are located in the appropriate product's `/com` or `/misc` production subdirectory.

Banner C Compile Procedures

Banner Product	Compile Procedures
A/R System	tascmplc
Advancement	alucmplc
Finance	fincmplc
Financial Aid	rescmplc
General	gencmplc
Payroll	paycmplc
Position Control	poscmplc
Student	stucmplc

Executables are built in the `$BANNER_HOME/general/exe` directory. This directory must be in the `PATH` of each Banner user.

UNIX

Below is a sample of the Banner General C compile shell script:

```
#!/bin/sh
#
cd $BANNER_LINKS
make -f $BANNER_HOME/general/c/sctproc.mk genobj \
CHECKOPT="sqlcheck=full userid=baninst1/u_pick_it"
make -f $BANNER_HOME/general/c/sctproc.mk gjrrpts
make -f $BANNER_HOME/general/c/sctproc.mk gurpded
make -f $BANNER_HOME/general/c/sctproc.mk glrletr
make -f $BANNER_HOME/general/c/sctproc.mk gppaddr
make -f $BANNER_HOME/general/c/sctproc.mk gurhelp
make -f $BANNER_HOME/general/c/sctproc.mk gurtabl
make -f $BANNER_HOME/general/c/sctproc.mk gurinso
make -f $BANNER_HOME/general/c/sctproc.mk gurskel
make -f $BANNER_HOME/general/c/sctproc.mk guaprf
make -f $BANNER_HOME/general/c/sctproc.mk gurjobs \
CHECKOPT="sqlcheck=full userid=baninst1/u_pick_it"
```

OpenVMS

Below is a sample of the Banner General C compile command script.

```
#! gencmplc.com
$ set def gen$c
@$gen$com:sctproc genobj$ "full userid=baninst1/u_pick_it"
@$gen$com:sctproc gjrrpts
@$gen$com:sctproc gurpded
@$gen$com:sctproc glrletr
@$gen$com:sctproc gppaddr
@$gen$com:sctproc gurhelp
@$gen$com:sctproc gurtabl
@$gen$com:sctproc gurinso
@$gen$com:sctproc gurskel
@$gen$com:sctproc guaprf
@$gen$com:sctproc gurjobs "full userid=baninst1 u_pick_it"
```

Windows

```
use sctcomp;
$sctcomp_product_dir = "general";
$sctcomp_input_file_ref = \*DATA;
$sctcomp_c_process;
_END_
guastdf.c -exetype=obj -checkopt=full
guaorac2.pc -exetype=obj -checkopt=full
guawslp.c -exetype=obj
guarpfe.c -exetype=obj -checkopt=full
gjpprun.pc -checkopt=full
gjrrpts.pc
gurpded.pc
glrletr.pc
gppaddr.pc
gurhelp.pc
gurinso.pc -ckeckopt=full
gurskel.pc
gurtabl.pc
guaprf.c
gurjobs.pc -checkopt=full
```

10 Desktop Tools



Desktop Tools

The Desktop Tools application allows Banner users to access their data from a PC application (for example, Microsoft Excel). Desktop Tools contains a PC Dynamic Link Library (.DLL) file and Microsoft Visual Basic runtime files. Together, the files accomplish the interconnection between the Banner database and PC applications.

Spreadsheet Budgeting is the first Banner enhancement that uses Desktop Tools to access data from the Banner Finance and Human Resources Systems.

Minimum System Requirements

To ensure the successful implementation of Desktop Tools, the following software must be installed on each PC:

- **Microsoft Windows 95/98, Windows 2000, or Windows NT 4.0.** These are the only operating systems supported for the Desktop Tools Application.
- **Microsoft Excel 97 or Excel 2002.** The Desktop Tools Application links Excel to Banner.

Note

If you set your Macro Security level to *High* in Excel2000, you will not be able to see the Banner menu. You must set the security level to *Medium* in Tools>Macros>Security to see it. ■

- **Microsoft ActiveX Data Objects (ADO) v2.1 (optional for DBA PC).** This is required for Excel and Banner to pass data. It is installed automatically when you install Desktop Tools Application.
- Oracle database, version 9.2.0.3 or greater.
- **Oracle Net8 Client Software or greater.** This is required for any application to communicate to the Oracle database like Banner.

Your institution must have at least one licensed copy of Visual Basic 6.0 (Professional Version) to compile the .DLL that is used in Spreadsheet Budgeting. For information about compiling and using the .DLL, see Updating Security Keys on page 3 and Compiling GODDTOP.DLL on page 4.

Installing Desktop Tools in a Windows Environment

DBA Machine

The following tasks are performed on the DBA machine:

- Unpack Desktop Tools (GODDTOP).
- Install Desktop Tools.
- Update security keys.
- Compile GODDTOP.DLL.

Once these tasks are performed, Desktop Tools can be installed on client machines.

Unpacking Desktop Tools (GODDTOP)

This task is performed on the DBA machine only.

1. Locate goddtop.exe in the BANNER_HOME\General\Desktop directory.
2. Copy goddtop.exe to a local directory on a Windows 95/98 or NT machine.
3. Double-click goddtop.exe to begin the unpacking. The installation program prompts you for the target directory of the install.
4. Select the target directory. (The default is C:\SCT\BANNER\GODDTOP.)
5. Select the components that you want to install into the target directory.
 - GODDTOP Setup Application—Select this component if you want to distribute the setup program to client machines. This component will be installed in the \setup folder of the target directory. The installed files can be used to initiate the GODDTOP installation on client machines.
 - GODDTOP Source Code—Select this component if you need to recompile a DLL or change the Visual Basic DLL. This component will be installed in the \source folder of the target directory. This component contains the source code needed to compile GODDTOP.DLL and the source code to ToolsUpdate, a small utility tool that allows easy updates of the DLL.
6. Select **Next** to install the selected components.

Installing Desktop Tools

You must install Desktop Tools on the DBA machine *before* you compile GODDTOP.DLL. This guarantees that the proper system files are installed before you compile.

If the GODDTOP Setup Application was selected while unpacking goddtop.exe, a \setup directory exists on the target directory. The setup directory contains the Desktop Tools setup file, goddtop-setup.exe.

 **Note**

Only one version of GODDTOP can be installed on your machine at a time. If an older version exists, uninstall it by using Add/Remove programs from the control panel before proceeding with the installation. ■

1. Reboot your machine. This is very important because you will be accessing some ODBC files that cannot be in memory.
2. Shut down all applications that open on reboot.
3. Copy goddtop-setup.exe to a temporary directory on your machine.

 **Note**

If a recompiled DLL exists, also copy that file to the temporary directory. ■

4. Double-click goddtop-setup.exe to invoke the setup application for Desktop Tools.
5. Select the target directory for the install. (The default is C:\SCT\BANNER\GODDTOP.)
6. Select **Next** to begin the installation.
7. If a recompiled DLL with new security keys exists, select **Yes** and follow these instructions:
 - 7.1. Select the location of the new DLL. It can reside on the network, in a different directory, or on a floppy disk.
 - 7.2. Select **OK** to proceed with the update.

 **Note**

Never copy a new DLL over an existing DLL. DLLs must be registered within the Windows registry. If not done properly, behavior of the Desktop Tools application is unpredictable. ■

8. If your machine is a Windows 95 machine, you are prompted to install DCOM95. Install DCOM and reboot.

Updating Security Keys

GODDTOP.DLL can optionally provide access to the Banner database the same way Banner forms access the database. By adding seed and database information, the DLL can

connect to the database the same way as the forms. Also, to limit the number of DLL files, the DLL can support multiple databases.

 **Note**

Even if you use baseline seed numbers, you must still update GODDTOP.DLL with your database definitions. ■

This task is performed on the DBA machine only.

 **Note**

This task is highly recommended but is not required. ■

1. Open Visual Basic 6.0.
2. Open the Visual Basic project file GODDTOP.vbp.
3. Press CTRL-R to make sure Project Explorer is open.
4. Go to Modules and then to modSecurityRoutines.
5. Find the procedure named LoadSecurityCollection.
6. Add a line of code to this procedure for each database to which you would like to grant access.

The following examples show a DLL that has access to two databases, `example_db1` and `example_db2`.

```
Public Sub LoadSecurityCollection()  
Set g_objSecurityCollection = New clsSecurityKeys  
  
'g_objSecurityCollection.AddSecurityString "database_name",  
G_DESKTOP_NAME, |  
G_DESKTOP_VERSION,  
"SEED1",  
"SEED3"  
  
g_objSecurityCollection.AddSecurityString "example_db1",  
G_DESKTOP_NAME,  
G_DESKTOP_VERSION,  
"12345678",  
"12345678"  
  
g_objSecurityCollection.AddSecurityString "example_db2",  
G_DESKTOP_NAME,  
G_DESKTOP_VERSION,  
"12345678",  
"12345678"  
  
End Sub
```

7. Select **Save**.

8. Exit Visual Basic.

Compiling GODDTOP.DLL

If you update security keys, you must compile GODDTOP.DLL. This task is performed on the DBA machine only.

1. Open Visual Basic 6.0.
2. Open the Visual Basic project file GODDTOP.vbp.
3. Select File and go to Make GODDTOP.DLL. The file name must be GODDTOP.DLL and should reside in the same directory as the source code.
4. Select **OK** to compile the DLL.
5. Find ToolsUpdate.exe on your machine. It is located in the selected install directory.
6. Double-click ToolsUpdate.exe.
7. Select the location of the new DLL. It can reside on the network, in a different directory, or on a floppy disk.
8. Select **OK** to proceed with the update.

Client Machines

You can install Desktop Tools on client machines *after* you compile GODDTOP.DLL on the DBA machine. Installation on client machines is the same as installation on the DBA machine.

Installing Desktop Tools in Other Environments

Macintosh

To install Desktop Tools on a Macintosh computer, you must use a PC emulator program. With a PC emulator program, you can install Desktop Tools following the procedures for installation on a regular PC.

Citrix

Perform the following steps to install Desktop Tools on machines that run the Citrix server software:

1. Log on to the console as the administrator.
2. Put the machine into *INSTALL* mode.
3. Restrict access to the machine.
4. Follow the steps for installation that appear on your screen.
5. Ensure that the specified user groups have access to GODDTOP.DLL and to GODDTOP.XLA.
6. Place GODDTOP.XLA into the Microsoft Office Library directory.

Forms

Desktop Tools Add – In Application Form (GOADADD)

This form lets you associate wizards and data lookups with an add-in, and specify the order in which the wizards and data lookups appear. You can associate multiple wizards and data lookups with a single add-in code.

Desktop Tools – Wizard Steps Setup Application Form (GOADSTE)

This form lets you assign steps (wizard windows) to a wizard, and assign specific property values to each step.

Desktop Tools – Step Property Values Rule Form (GORDPRP)

This form lets you associate values with the property codes that are defined on the Desktop Tools - Step Property Validation Form (GTVDP RP). A value is a specific object, such as a picture of a bag of money, that belongs to a property category such as “Picture.” A step is a collection of properties that appears on a wizard window and controls the way a user interacts with an add-in. You can use the values delivered with Banner, or you can create your own. You can associate multiple values with a single property code.

Desktop Tools – User Security Rule Form (GORDSEC)

This form lets you establish user access for the specific wizards associated with an add-in. You can grant a user access to the wizards from multiple add-ins, if necessary. For example, in Banner Spreadsheet Budgeting, you can grant a user authorization to download, validate, and/or upload data from and to Banner tables. You can copy user privileges from one ID to another.

Desktop Tools – Step Type Properties Rule Form (GORDSTP)

This form lets you associate properties with a step type code. A step is a collection of properties that appears on a wizard window and controls the way a user interacts with an add-in such as Banner Spreadsheet Budgeting. This form lets you customize the appearance of each wizard window.

Desktop Tools – Add-In Validation Form (GTVDADD)

This form lets you create and maintain add-in codes. An add-in is a program, such as Banner Spreadsheet Budgeting, that adds extra features to an application such as Microsoft Excel. You can use the add-in codes delivered with Banner, as well as create your own.

Desktop Tools – Step Property Validation Form (GTVDPRP)

This form lets you create and maintain property codes. A property is a type of object, such as a radio button or a picture, that appears on a step (wizard window). When combined with steps, properties control the way a user interacts with an add-in such as Banner Spreadsheet Budgeting.

Desktop Tools – Step Type Validation Form (GTVDSTP)

This form lets you create and maintain step type codes. A step is a collection of properties that appears on a wizard window and controls the way a user interacts with an add-in such as Banner Spreadsheet Budgeting.

Tables

GTVDADD	Desktop Tools--Add-In Validation Table
GTVDPRP	Desktop Tools--Step Property Validation Table
GORDPRP	Desktop Tools--Step Property Repeating Table
GTVDSTP	Desktop Tools--Step Type Validation Table
GORDSTP	Desktop Tools--Step Type Property Repeating Table
GORDSEC	Desktop Tools--User Security Repeating Table
GORDWIZ	Desktop Tools--Add-In Wizard Association Repeating Table
GORDLUP	Desktop Tools--Add-In Data Lookup Repeating Table
GORDSTE	Desktop Tools--Wizard Step Repeating Table
GORDSPR	Desktop Tools--Wizard Step Properties Repeating Table

GOTDWKS	Worksheet Snapshot Table
GOTDMSG	Temporary Desktop Tools Message Table
GOTDPAR	Temporary Desktop Parameters Table

For details on the current supported version, please refer to the Customer Support Center.



Banner is a complex system with many parts that work together to manage your institution's data and to interact with users. When any one of the components of the system is missing, some of the system's functions may fail or may not work as intended.

In some cases, data itself can be considered an essential component of the system. The complete contents of certain tables, and specific rows in other tables, must be present for the system to work correctly. This essential data is called *system-required data*. System-required data is a subset of the seed data delivered with a new Banner installation. New Banner software releases often include seed data scripts that deliver additional system-required data.

Generally, Banner forms and processes will prevent you from deleting system-required data. But when you are using database tools or scripts to delete rows from the database—for example, during database cleanup to remove sample data before migrating into production—there is nothing to prevent essential data from being accidentally deleted. In those situations, you should take care not to delete any system-required data.

In many tables there is a **System-Required Indicator** column (for example, `SYSTEM_REQ_IND`). If the indicator has a value of *Y*, the row is presumed to be system required. But the system-required indicator is not a foolproof guide to Banner's system-required data, because:

- Some tables do not have a system-required indicator, but nonetheless contain essential data.
- Some tools and processes allow users to mark rows as system required, even if they are not essential for system operation.

This chapter lists system-required data for Banner General. Other system-required data is listed in the following documents:

- *Banner GTVSDAX Handbook*
- *Banner Accounts Payable TRM Supplement*
- *Banner Advancement TRM Supplement*
- *Banner Finance TRM Supplement*
- *Banner Financial Aid TRM Supplement*
- *Banner Human Resources TRM Supplement*
- *Banner Student TRM Supplement*

System-Required Tables

Tables Owned by BANSECR

Tables owned by the BANSECR user ID provide the data for Banner's object/user security system, including the permissions that allow the components of the Banner system to operate. These tables should never be included in automated database purge processes. If it becomes necessary to clean up the tables owned by BANSECR, it should be done carefully and manually by an administrator familiar with the institution's security setup.

Large Tables

Some General tables are delivered with hundreds of system-required rows, and it would be impractical to reprint their complete data here. Before making changes to these tables, you may wish to save an export of their data in case it becomes necessary to restore them later.

- Report/Process Definition Table (GJBJOBS)
- Jobs Parameter Definition Table (GJBPDEF)
- Default Parameter Table (GJBPDFT)
- General Jobs Parameter Value Table (GJBPVAL)
- Letter Generation Variable Base Table (GLBVRBL)
- Population Selection Rules Table (GLRSLCT)
- Letter Generation Variable Select Table (GLRVFRM)
- Letter Generation Variable Rules Table (GLRVRBL)
- Third-Party Function Calls Table (GOBFNXR)
- Parameter Group Code Rule Table (GOREQPG)
- Third-Party Function Parameters Table (GORPPRM)
- Third-Party Electronic Controls Table (GORTCTL)
- Voice Response Controls Table (GORVCTL)
- Parameters Table (GORWFPM)
- EDI Standard Code Validation Table (GTVSCOD)
- SEVIS Consular Post Codes Validation Table (GTVSVCP)
- General Menu Repeating Table (GURMENU)
- Banner Business Entity Table (GURMESG)
- Option Menu Repeating Table (GUROPTM)

Other Tables

The Crosswalk Validation Table (GTVSDAX) contains important SunGard-delivered data. See the *Banner GTVSDAX Handbook* for complete details.

Seed data for the FGAC Domain Policy Table (GORFDPL) is documented in the *Banner Data Security Handbook* (formerly titled *Banner FGAC Handbook*).

The Institutional Description Table (GUBINST) must contain at least one row. It is delivered with example data that you can modify or replace with your own institution's data.

Normally, you will have no reason to edit the following tables that contain system-required data:

- The General Version Tracking Table (GURVERS), which tracks the version history of the Banner General product
- The Dynamic Help Table (GUBBHLP), which holds the SunGard-delivered Dynamic Help for Banner forms, blocks, and fields.

System-Required Rows

Specific SunGard-delivered, system-required values are listed in this section, organized alphabetically by table name.

Even though these are considered system-required values, not all of the values listed here need to be present in every institution's Banner database. Many of the tables and values support specific Banner systems, subsystems, and functions. If your institution does not use those components of Banner, then the absence of the corresponding data will not cause any problem.

As an example, the FGAC Domain Driver Table Table (GOBFDMN) maintains driver tables for VBS and PII processing. In the section below, you will see driver tables listed in GOBFDMN for all of the Banner products. If your institution has not implemented Banner Finance, for example, then the absence of Finance driver table entries in the GOBFDMN table would not cause any problems.

GLBAPPL	Letter Generation Application Table	
Application	Description	System Code
ALUMNI	BANNER Alumni/Development	A
FINAID	Financial Aid Application	R
WKBOOK	Sample Application for G01C	G
COURTS	Banner Courts	C
HRAPPL	HR Applicant	H

GLBAPPL**Letter Generation Application Table**

Application	Description	System Code
HREMPPL	HR Employee	H
WORKBOOK	Letter Generation Workbook	S
STUDENT	Student Module	S
GENERAL	General Module	G
RECRUITING	BANNER Student Recruiting Mod.	S
ADMISSIONS	BANNER Student Admissions Mod.	S
HOUSING	BANNER Student Housing Module	S
BANSTU_SAMPLE	Student Sample Data Examples	S
PIN_RESET	PIN Reset Notification	G
COBRA_APPL	Cobra Application	H

GLBOBJT**Letter Generation Object Base Table**

MARRIED	Select Married Persons
DIVORCED	Select Divorced Persons
SINGLE	Select Single Persons
NOT_DEAD	Not Dead Rules
WOMEN	Select Women
RECR_TERM	Recruit Term
MEN	Select Men
RCRAPP1-RCRAPP2_JOINS	table joins
RECR_COLL	Recruit College
RECR_MAJR	Recruit Major
RECR_LEVEL	Recruit Level
PERSON_RECORD	person
CURRENT_NAME_ID	most accurate name and ID

GLBSLCT**Population Selection Base Table**

Application	Selection	Creator ID	Description
FINAID	NOVER_NOTPACKAGED	FAISMGR	not selected - not packaged
FINAID	TEMP	FAISUSR	Temporary
STUDENT	199510_NEW_FROSH	SAISUSR	199510 New Frosh Registrations
STUDENT	199510_NEW_UG_FROSH	SAISUSR	199510 New Frosh Enrollees
ALUMNI	CLASS72	ADISUSR	Alumni by preferred class
ALUMNI	CLASS86	ADISUSR	Alumni by preferred class
ALUMNI	PREF_CLASS	ADISUSR	Alumni by preferred class
ALUMNI	PROSPECTS	ADISUSR	All prospects

GLBSLCT**Population Selection Base Table**

Application	Selection	Creator ID	Description
ALUMNI	PROS_RESEARCH	ADISUSR	Prospect Research Population
FINAID	PRIORITY_LATE	FAISMGR	late applicants
FINAID	PRIORITY_ONTIME	FAISMGR	on time applicants
RECRUITING	199301_RECRUITS	SAISUSR	Selection of 1993 Recruits
FINAID	SELECTED-NOTCOMP	FAISMGR	sel for verif. - not completed
FINAID	DORM	FAISMGR	Housing Code Selection
FINAID	UMETNEED	FAISMGR	Need
FINAID	UNMET	FAISMGR	Need
FINAID	MANUAL	FAISMGR	manual pop selection
FINAID	ALL_REQ_COMP	FAISUSR	All Requirements Complete
FINAID	AWARD_LTR	FAISPRD	Students Needing Award Letters
FINAID	NEEDY_FROM_PA	FAISUSR	Needy From PA
FINAID	NEEDY	FAISPRD	Students With Large Gross Need
HREMP	DEDN	HRISUSR	Employee Dedn List
ALUMNI	NEGATIVE_AMOUNT_DUE	ADISUSR	Negative amount due-membership
ALUMNI	FORM_NOT_RECEIVED	ADISUSR	Matching Gift Form Not Recvd
ALUMNI	GROUPED_GIFTS_IDS	ADISUSR	IDs with grouped gifts
WKBOOK	MEN	SAISUSR	Select All Men
FINAID	TRACK2	FAISMGR	Never had a tracking letter
FINAID	TRACK1	FAISMGR	Track Letter not sent since
FINAID	AWARD_FLAG	FAISMGR	Award Letter Flag = 'Y'
FINAID	TRACK_FLAG	FAISMGR	Track Letter Flag = 'Y'
FINAID	VA_BENEFITS	FAISMGR	receiving va benefits
FINAID	SS_BENEFITS	FAISMGR	Receiving SS benefits
STUDENT	199510_NEW_UG_TRAN	SAISUSR	199510 New Frosh Enrollees
FINAID	CHILD_CARE	FAISMGR	have dependent child expenses
FINAID	NONCITIZEN	FAISMGR	not a U.S. citizen
BANSTU_SAMPLE	TS_CONTRACTS	SAISUSR	Students with Contracts
BANSTU_SAMPLE	TS_EXEMPTIONS	SAISUSR	Students with Exemptions
FINAID	MANUAL	FAISUSR	Manual
BANSTU_SAMPLE	199610_ENROLLED	SAISUSR	199610 enrolled students
BANSTU_SAMPLE	MEN	SAISUSR	Select Men
WKBOOK	199610_ENROLLED	SAISUSR	199610 Enrolled Students
BANSTU_SAMPLE	199510_NEW_AND_TRANS	SAISUSR	199510 N & T enrolled UG
WKBOOK	199610_CURR_STU	SAISUSR	199610 Current Students
FINAID	RORSTAT_RECORD	FAISMGR	has rorstat record in aid year

GLBSLCT

Population Selection Base Table

Application	Selection	Creator ID	Description
BANSTU_SAMPLE	199510_UG_NEW	SAISUSR	199510 Ug, New
ADMISSIONS	199610_APPLICANTS	SAISUSR	Fall 1996 Applicants
FINAID	AFDC	FAISMGR	afdc recipient
FINAID	RCRAPP_RECORD	FAISMGR	Need Analysis Records
FINAID	BGRP	FAISMGR	all students in budget group
FINAID	TGRP	FAISMGR	all students in track group
FINAID	PGRP	FAISMGR	all students in pkg group
FINAID	CHILDSUPPORT	FAISMGR	receive child support
FINAID	CITIZENSHIP	FAISMGR	citizenship verification
FINAID	COMPLETE_DISB_REQ	FAISMGR	all disb req. complete
FINAID	COMPLETE_PCKG_REQ	FAISMGR	all pkg req. complete
FINAID	COMPLETE_TRACKING	FAISMGR	all requirements complete
HOUSING	HOUSING_ASSIGNMENTS	SAISUSR	Active Housing Assignments
FINAID	MANUAL1	FAISUSR	manual1

For all entries listed above, **Lock Indicator** is *N*, and **Type** is null.

GLRAPPL

Letter Generation Application Rules Table

Application	Seq. No.	Line No.	Data Element	Operator	Value	()	AND/OR
ADMISSIONS	5	1	SARADAP_TERM_CODE_ENTRY	=	&APPLICATION_TERM		
RECRUITING	4	1	SRBRECR_TERM_CODE	=	&RECRUITING_TERM		
COURTS	1	1	CDBCASE_ID	IS NOT NULL			
HRAPPL	1	1	PABAPPL_PIDM	=	SPRIDEN_PIDM		AND
HRAPPL	2	2	SPRIDEN_ENTITY_IND	=	P		AND
HRAPPL	3	3	SPRIDEN_CHANGE_IND	IS NULL			
HREMP	1	1	PEBEMPL_PIDM	=	SPRIDEN_PIDM		AND
HREMP	2	2	SPRIDEN_ENTITY_IND	=	P		AND

GLRAPPL Letter Generation Application Rules Table

Application	Seq. No.	Line No.	Data Element	Operator	Value	()	AND/OR
HREMP	3	3	SPRIDEN_CHANGE_IND	IS NULL			
WORKBOOK	1	1	SPRIDEN_CHANGE_IND	IS NULL			AND
WORKBOOK	2	2	SPRIDEN_ENTITY_IND	=	P		AND
WORKBOOK	3	3	SPBPERS_DEAD_IND	IS NULL			

GLROBJT Letter Generation Object Rules Table

Object	Seq. No.	Line No.	Data Element	Operator	Value	()	AND/OR
RECR_COLL	1	1	SRBRECR_COLL_CODE	=	&recr_coll		
MARRIED	1	1	SPBPERS_MRTL_CODE	=	M		
DIVORCED	1	1	SPBPERS_MRTL_CODE	=	D		
SINGLE	1	1	SPBPERS_MRTL_CODE	=	S		
NOT_DEAD	1	1	SPBPERS_DEAD_IND	IS NULL			
WOMEN	1	1	SPBPERS_SEX	=	F		
RECR_COLL	1	1	SRBRECR_COLL_CODE	=	&recr_coll		
MARRIED	1	1	SPBPERS_MRTL_CODE	=	M		
DIVORCED	1	1	SPBPERS_MRTL_CODE	=	D		
SINGLE	1	1	SPBPERS_MRTL_CODE	=	S		
NOT_DEAD	1	1	SPBPERS_DEAD_IND	IS NULL			

GLROBJT Letter Generation Object Rules Table

Object	Seq. No.	Line No.	Data Element	Operator	Value	()	AND/OR
WOMEN	1	1	SPBPERS_SEX	=	F		
RECR_TERM	1	1	SRBRECR_TERM_CODE	=	&recr_term		
MEN	1	1	SPBPERS_SEX	=	M		
RCRAPP1- RCRAPP2_ JOINS	1	1	RCRAPP1_PIDM	=	RCRAPP2_PIDM		AND
RCRAPP1- RCRAPP2_ JOINS	2	2	RCRAPP1_AIDY_CODE	=	RCRAPP2_AIDY_CODE		AND
RCRAPP1- RCRAPP2_ JOINS	3	3	RCRAPP1_INFC_CODE	=	RCRAPP2_INFC_CODE		AND
RCRAPP1- RCRAPP2_ JOINS	4	4	RCRAPP1_SEQ_NO	=	RCRAPP2_SEQ_NO		
RECR_MAJR	1	1	SRBRECR_MAJR_CODE	=	&recr_majr		
RECR_LEVL	1	1	SRBRECR_LEVL_CODE	=	&recr_levl		
PERSON_ RECORD	1	1	SPRIDEN_ENTITY_IND	=	P		
CURRENT_ NAME_ID	1	1	SPRIDEN_CHANGE_IND	IS NULL			

GLRSFRM Population Selection Select Table

Application	Selection Code	Select Clause	From Clause	Order By	Group By
ALUMNI	CLASS72	APBCONS_PIDM	APBCONS		
ALUMNI	CLASS86	APBCONS_PIDM	APBCONS		
ALUMNI	PREF_CLASS	APBCONS_PIDM	APBCONS		
ALUMNI	PROSPECTS	AMRINFO_PIDM	AMRINFO		

GLRSFRM

Population Selection Select Table

Application	Selection Code	Select Clause	From Clause	Order By	Group By
ALUMNI	PROS_RESEARCH	AMRPUSR_PIDM	AMRPUSR, APBCONS		
RECRUITING	199301_RECRUITS	SRBRECR_PIDM	SRBRECR		
FINAID	DORM	RORSTAT_PIDM	RORSTAT	RCRAPP1	
FINAID	UMETNEED	RORSTAT_PIDM	RORSTAT	RCRAPP1	
FINAID	UNMET	RORSTAT_PIDM	RORSTAT	RCRAPP1	
HREMP	DEDN	PDRDEDN_PIDM	PDRDEDN		
FINAID	ALL_REQ_COMP	RORSTAT_PIDM	RORSTAT		
FINAID	AWARD_LTR	RORSTAT_PIDM	RORSTAT		
FINAID	NEEDY	RORSTAT_PIDM	RORSTAT		
FINAID	NEEDY_FROM_PA	RORSTAT_PIDM	RORSTAT	RCRAPP1	
FINAID	AFDC	RORSTAT_PIDM	RORSTAT, RCRAPP1		
FINAID	BGRP	RORSTAT_PIDM	RORSTAT		
FINAID	TGRP	RORSTAT_PIDM	RORSTAT		
ALUMNI	NEGATIVE_AMOUNT_DUE	AARMEMB_PIDM	AARMEMB A		
FINAID	PGRP	RORSTAT_PIDM	RORSTAT		
FINAID	CHILDSUPPORT	RORSTAT_PIDM	RORSTAT, RCRAPP1		
FINAID	CITIZENSHIP	RORSTAT_PIDM	RORSTAT, RCRAPP1		
FINAID	COMPLETE_DISB_REQ	RORSTAT_PIDM	RORSTAT		
FINAID	COMPLETE_PCKG_REQ	RORSTAT_PIDM	RORSTAT		
FINAID	COMPLETE_TRACKING	RORSTAT_PIDM	RORSTAT		
FINAID	NOVER_NOTPACKAGED	RORSTAT_PIDM	RORSTAT, RCRAPP1		
FINAID	PRIORITY_LATE	RORSTAT_PIDM	RORSTAT		
FINAID	PRIORITY_ONTIME	RORSTAT_PIDM	RORSTAT		

GLRSFRM

Population Selection Select Table

Application	Selection Code	Select Clause	From Clause	Order By	Group By
FINAID	SELECTED-NOTCOMP	RORSTAT_PIDM	RORSTAT , RCRAPP1		
ALUMNI	FORM_NOT_RECEIVED	AGBMGID_EMPL_P IDM	AGBGIFT , AGBMGID		
ALUMNI	GROUPED_GIFTS_IDS	AGRRCPT_PIDM	AGRRCPT		
WKBOOK	MEN	SPBPERS_PIDM	SPBPERS		
FINAID	TRACK2	RORSTAT_PIDM	RORSTAT , RRRAREQ		
FINAID	TRACK1	RORSTAT_PIDM	RORSTAT	RRRAREQ	SPRIDEN GURMAIL A
FINAID	AWARD_FLAG	RORSTAT_PIDM	RORSTAT	SPRIDEN	
FINAID	TRACK_FLAG	RORSTAT_PIDM	RORSTAT	SPRIDEN	
FINAID	VA_BENEFITS	RORSTAT_PIDM	RORSTAT , RCRAPP1		
FINAID	SS_BENEFITS	RORSTAT_PIDM	RORSTAT	RCRAPP1	
STUDENT	199510_NEW_FROSH	SGBSTDN_PIDM	SGBSTDN A		
STUDENT	199510_NEW_UG_ FROSH	SGBSTDN_PIDM	SGBSTDN A		
STUDENT	199510_NEW_UG_TRAN	SGBSTDN_PIDM	SGBSTDN A		
FINAID	CHILD_CARE	RCRAPP3_PIDM	RCRAPP1	RCRAPP3	
FINAID	NONCITIZEN	RCRAPP1_PIDM	RCRAPP1		
BANSTU_SAMPLE	TS_EXEMPTIONS	TBBESTU_PIDM	TBBESTU		
BANSTU_SAMPLE	199610_ENROLLED	SFBETRM_PIDM	SFBETRM		
BANSTU_SAMPLE	MEN	SPBPERS_PIDM	SPBPERS		
WKBOOK	199610_ENROLLED	SFBETRM_PIDM	SFBETRM		
BANSTU_SAMPLE	199510_NEW_AND_ TRANS	SGBSTDN_PIDM	SGBSTDN A		

GLRSFRM**Population Selection Select Table**

Application	Selection Code	Select Clause	From Clause	Order By	Group By
WKBOOK	199610_CURR_STU	SGBSTDN_PIDM	SGBSTDN A		
FINAID	RORSTAT_RECORD	RORSTAT_PIDM	RORSTAT	SPRIDEN	
BANSTU_SAMPLE	199510_UG_NEW	SGBSTDN_PIDM	SGBSTDN A		
ADMISSIONS	199610_APPLICANTS	SARADAP_PIDM	SARADAP		
FINAID	RCRAPP_RECORD	RORSTAT_PIDM	RCRAPP1	RORSTAT	
HOUSING	HOUSING_ASSIGNMENT	SLRRASG_PIDM	SLRRASG, STVASCD		

GOBDIRO**Directory Options Rule Table**

Directory Code	Directory Type	Item Type	Sequence Number
NAME	A	N	1
ADDR_PR	A	A	2
TELE_PR	A	T	3
ADDR_CP	S	A	4
TELE_CP	S	T	5
ADDR_OF	E	A	6
TELE_OF	E	T	7
TELE_FAX	A	T	8
DEPT	E	N	9
GRD_YEAR	S	N	10
COLLEGE	S	N	11
TITLE	E	N	12
EMAIL	A	N	13
MAIDEN	D	N	14
ADDR_HO	A	A	15
TELE_HO	A	T	16
ADDR_BU	A	A	17
TELE_BU	A	T	18

GOBDIRO**Directory Options Rule Table**

Directory Code	Directory Type	Item Type	Sequence Number
CLASS_YR	D	N	19
PR_COLL	D	N	20

For all entries above, **Included in Directory** is *N*, **Display in Directory** is *N*, and **Default Indicator** is *N*.

GOBFDMN**FGAC Domain Driver Table Table**

Domain Code	Table Name	Type	PII Column Name
TB_ACCOUNT_PII	TBRACCD	PII	TBRACCD_PIDM
FB_CUSTOMER_PII	FTVCUST	PII	FTVCUST_PIDM
FB_EMPLOYEE_PII	FCBEMPL	PII	FCBEMPL_PIDM
FB_VENDOR_PII	FTVVEND	PII	FTVVEND_PIDM
FB_MANAGER_PII	FTVFMGR	PII	FTVFMGR_FMGR_CODE_PIDM
FB_AGENCY_PII	FTVAGCY	PII	FTVAGCY_AGCY_CODE_PIDM
GB_FGACACCESS_VBS	GOBFGAC	VBS	
GB_FGAC_PREDICATE_VBS	GORFPRD	VBS	
GB_INTERNATIONAL_VBS	GOBINTL	VBS	
GB_SPRADDR_VBS	SPRADDR	VBS	
GB_SPRMEDI_VBS	SPRMEDI	VBS	
GB_SPRTELE_VBS	SPRTELE	VBS	
PB_APPLICANT_PII	PABAPPL	PII	PABAPPL_PIDM
PB_BENEFITS_PII	PDRBENE	PII	PDRBENE_PIDM
PB_COBRA_PII	PCBPERS	PII	PCBPERS_PIDM
RB_FINAID_PII	RORSTAT	PII	RORSTAT_PIDM
SB_ADMISSIONS_PII	SARADAP	PII	SARADAP_PIDM
SB_FACULTY_PII	SIBINST	PII	SIBINST_PIDM

GOBFDMN**FGAC Domain Driver Table Table**

Domain Code	Table Name	Type	PII Column Name
SB_HOUSING_PII	SLBRMAP	PII	SLBRMAP_PIDM
SB_GENSTUDENT_PII	SGBSTDN	PII	SGBSTDN_PIDM
SB_RECRUIT_PII	SRBRECR	PII	SRBRECR_PIDM
SB_REGISTRATION_PII	SFBETRM	PII	SFBETRM_PIDM
SB_TRANSFER_PII	SHRTTRM	PII	SHRTTRM_PIDM
AB_CONSTITUENT_PII	APBCONS	PII	APBCONS_PIDM
AB_ORG_PII	AOBORGN	PII	AOBORGN_PIDM
SB_RECRUIT_VBS	SRBRECR	VBS	
PB_EMPLOYMENT_PII	PEBEMPL	PII	PEBEMPL_PIDM
SB_LEARNER_VBS	SGBSTDN	VBS	
SB_CATALOG_VBS	SCBCRSE	VBS	
SB_SCHEDULE_VBS	SSBSECT	VBS	
RB_FINAID_VBS	RORSTAT	VBS	
RB_FINAID_STUDENT_VBS	RORSTAT	VBS	
SB_CURRICULUM_VBS	SORLCUR	VBS	
SB_FIELDOFSTUDY_VBS	SORLFOS	VBS	
SB_ADMISSIONS_VBS	SARADAP	VBS	
SB_TESTCODES_VBS	STVTESC	VBS	
SB_TESTSCORE_VBS	SORTEST	VBS	
SB_OTHERGPA_CODES_VBS	STVGPAT	VBS	
SB_OTHERGPA_VBS	SORGPAT	VBS	
SB_OTHERGPA_STUDENT_VBS	SORGPAT	VBS	
SB_TESTSCORE_STUDENT_VBS	SORTEST	VBS	

For all entries above, **Enable PII Indicator** is delivered with the value *N*.

GOBFDTP**FGAC Domain Type Rule Table**

Domain Type Code	Predicate Indicator
PII	N
VBS	Y

GOBFEOB**Objects Excluded from FGAC Processing Rules Table**

This table lists objects that bypass FGAC rules. Objects listed in GOBFEOB have full access to data regardless of VBS or PII rules that might otherwise apply. Following is the complete list of objects included in seed data for GOBFEOB, organized alphabetically.

AAPACKN, AAPADJS, AAPCARD, AAPFEED, AAPREMD, AAPRNEW, AAPSTAT, ADPACCT, ADPCFAE, ADPEXP, ADPFEED, ADPPFED, ADPVSER, AFPCAMR, AFPDONR, AFPSOLA, AFPSOLB, AFPSOLC, AFPTSELF, AGPACCT, AGPACKN, AGPACKR, AGPADJS, AGPALMP, AGPCASH, AGPDCGL, AGPGANL, AGPGCOM, AGPLYSY, AGPMATA, AGPMATC, AGPMATF, AGPMATG, AGPMATS, AGPPACT, AGPPOUT, AGPREM1, AGPREM2, AGPSCTA, AGPTLMK, ALPMAIL, ALPMSEL, APAPPFL, APPAPFL, APPCEN1, APPCEN2, APPCLST, APPCONS, APPCUPD, APPDCAR, APPDCLB, APPDCLS, APPDEXT, APPDFLS, APPDPRC, APPSTDI, ASPSOLA, ASPSOLB, ASPSORL, AXPMATG

BWPREDIR

CRQC3000

FAB1099, FABCHK1, FABCHKA, FABCHKD, FABCHKP, FABCHKR, FABCHKS, FABMATC, FAM1099, FAPCARD, FAPCDIR, FAPDIRD, FAPINVT, FAPTREG, FARAAGE, FARBBAL, FARBREC, FARCHKR, FARCHSHR, FARDIRD, FARIAGE, FARINVA, FARINVS, FARIREC, FAROINV, FARVALP, FARVHST, FARVNUM, FARWHLD, FARWHLY, FAT1099, FATCHK, FBRAPPD, FBRAPPR, FBRBDBB, FBRBDDS, FBRBDRL, FBRFEED, FBRMCHG, FBRWKSH, FCBBILL, FCBEQPT, FCBINVT, FCBLABR, FCBMATL, FCRBDTR, FCRSCHD, FCRVARA, FEPOEXT, FFPDEPR, FFPOEXT, FFRAGRP, FFRDTGA, FFRDTGT, FFRMAST, FFRPROC, FFRPROP, FPGEXT, FGRACCI, FGRACTG, FGRACTH, FGRACTV, FGRAGYH, FGRBAVL, FGRBDRL, FGRBDSC, FGRBIEX, FGRBLSH, FGRCASH, FGRCBSR, FGRCGBA, FGRCGBS, FGRCHF, FGRCHNA, FGRCLOP, FGRCOBS, FGRCREG, FGRCSBA, FGRCSCF, FGRCSRE, FGRCSR, FGRCSSR, FGRCTRL, FGRCU-NA, FGRENRL, FGRFAAC, FGRFBAL, FGRFITD, FGRFNDH, FGRFPSN, FGRGLEX, FGRGLRL, FGRGLTA, FGRIDOC, FGRJVL, FGRLOCH, FGRRODTA, FGRROPNE, FGRORGH, FGRPDTA, FGRPRAP, FGRPRAR, FGRPRGH, FGRREOB, FGRREOC, FGRTAXR, FGRTBAL, FGRTBEX, FGRTOFR, FGRTNRH, FGRTNRNI, FGRTRNR, FIRBVAL, FIRDIST, FIRLINK, FIRPVAL, FIRRDST, FIRUNIT, FNPAIN, FNPSPND, FNPUNTZ, FNRHIST, FNRPRNC, FNRSPNC, FOIIDEN, FORAPPL, FPABIDD, FPACORD, FPAPORD, FPARQST, FPPPOBC, FPRBEVL, FPRDELV, FPROPNP, FPROPNR, FPRPURA, FPRRCDL, FPRRST, FPRVCAT, FPRVOL, FPTBIDD, FPTPORD, FPTQST, FRPBINF, FRPINF, FRPMESG, FRR134B, FRR269R, FRR270B, FRR272B, FRR272R, FRRABUD, FRRAGES, FRRAGYH, FRRBDEX, FRRBEXC, FRRBILL, FRRBREV, FRRBUDG, FRRNSF, FRRVNG, FRRVNP, FRRFEXC, FRRGBFY, FRRGENB, FRRGENR, FRRGITD, FRRGPY, FRRGRNT, FRRGRPT, FRRGRTN, FRRINDC, FRRINVS, FRRTRNR, FSRDTLG, FSRINVL, FSRISST, FSRLWSR, FSRÖPNR, FSRÖUTP, FSRPHYR, FSRPICK, FSRPIDR, FSRPIWS, FSRPUTL, FSRSTEX, FSRSUPC, FUPLOAD, FURAPAY, FURFEED

GJRRPTS, GLBDATA, GLBLSEL, GLBPARM, GLOLETT, GLRLETR, GOAEACC, GOAFPPII, GOAMTCH, GORP-GEO, GORSEVE, GORSSEO, GPPADDR, GUASYST, GUAVRFY, GUIALTI, GUPDEL, GURDET, GURHELP, GURINSO, GURPED, GURTABL, GURTEXT, GURTPAC

HWPREDIR, HWSRCTLG, HWSRSCHD

IRRKAWD, IRRKTRK, IRRKTRN, ISRKADM, ISRKABIL, ISRKRCS, ISRKGRD, ISRKSCH, ISRKTRN

NBPBROL, NBPBUDM, NBPENCB, NBPMASS, NBPSPEX, NBPSPUP, NBRBWRK, NBRPCLS, NBRPINC, NBRPOSN, NBRPSTA, NHPFIN1, NHPFIN2, NHRBDST, NHRDIST, NHRECRT, NHREDST, NHRSDST, NOPE-AMA, NORAPT

PARAPPL, PARMAPP, PARREQS, PCRCORT, PCRLTRS, PCRN0TF, PCRRATE, PDP1042, PDPBDMC, PDPC-FLX, PDPF496, PDPFLEX, PDPLIFE, PDPMR87, PDPPERS, PDRBCOV, PDRBFDN, PDRBLST, PDRFLEX, PDRFLXU, PDRFUPT, PDRLIFE, PEP1042, PEPAXT, PEPICAL, PEPEDEX, PEPFACL, PEPPCRE, PER-APND, PERCAF7, PERE011, PERE01D, PERE041, PERE04D, PERE051, PERE05D, PERE061, PERE062, PERE06D, PERFACL, PERHIRE, PERLEAV, PERORGC, PEROSHA, PERPAPP, PERPGAN, PERPHIR,

PERPTER, PERREVV, PERROEC, PERTERM, PERTTTT, PERUTAN, PERV100, PERWFAN, PHPBOND, PHPBREC, PHPCALC, PHPCDIR, PHPCHEK, PHPCHKL, PHPDIRD, PHPDOC, PHPFEXP, PHPLEAV, PHPMTIM, PHPPROF, PHPRETO, PHPTIME, PHPUPDT, PHRCOST, PHRCISS, PHRCOST, PHRDCON, PHRDERR, PHRDIRD, PHRDREG, PHRDSTT, PHRFACE, PHRHOUR, PHRLGST, PHRLRAR, PHRRORT, PHRRREG, PHRRST, PHRSTCA, PHRTMSH, PHRTREG, PORADUT, PORAUDT, PORPPFL, PPRSINV, PXP1099, PXPMT42, PXPMTT4, PXPMTTA, PXPMTTN, PXPW2MM, PXPW2MP, PXPW2TP, PXR1042, PXR1099, PXRASCD, PXRLIST, PXR941, PXRROEC, PXRT4AC, PXRT4AN, PXRT4CN, PXRTDEP, PXRW2PR, PXRW2US

RBRABUD, RBRBCMP, RCBCT05, RCBCT06, RCBTP05, RCBTP06, RCMATCH, RCPDTPM, RCPIMFM, RCPMTCH, RCRTPO3, RCRTPO4, RCRTPO5, RCRTPO6, REBCD00, REBCD01, REBCD02, REBCD03, REBCD04, REBCD05, REBCD06, RERCALX, RERCRCR, REREX03, REREX04, REREX05, RERFI00, RERFI01, RERFI02, RERFI03, RERFI04, RERFI05, RERFI06, RERIM03, RERIM04, RERIM05, RERIMEX, RERIS00, RERIS01, RERIS02, RERIS03, RERIS04, RERIS05, RERIS06, RERPELL, RERPL01, RERPL02, RERPL03, RERPL04, RERPL05, RERPRO0, RERPRO1, RERPRO2, RERPRO3, RERPRO4, RERPRO5, RESDTPM, RFRABAL, RFRBUDG, RFRFUND, RFRSBAL, RHRCOMM, RHRFATR, RHRTRAN, RJRAUTH, RJRDPPR, RJRLOAD, RJRPAYE, RJRSEEC, RLRLETR, RLRLLOGG, RNEIN00, RNEIN01, RNEIN02, RNEIN03, RNEIN04, RNEIN05, RNEIN06, RNRPINI, RNRTMAC, RNRTMNE, RNRTMNI, RNRVRFY, ROBBGRP, ROESAPR, ROOAUTO, ROOQSOL, ROPROLL, ROPSAPR, RORALOG, RORAPLT, RORBPST, RORCALC, RORFS00, RORFS01, RORFS02, RORFS03, RORFS04, RORGRDE, RORREGS, RORUSER, RPBDDRV, RPBLMIA, RPBLMID, RPBLMIE, RPBPDV, RPBVDRV, RPBVLDT, RPEDISB, RPEPCKG, RPEPELL, RPEPINT, RPRADSB, RPRAWDB, RPRAWRD, RPRCNCL, RPRCP01, RPRCP02, RPRCP03, RPRCP04, RPRCP05, RPRDDUP, RPRDLLC, RPRDLLR, RPRDLPM, RPRDSPT, RPRDU00, RPRDU01, RPRDU02, RPRDU03, RPRDU04, RPRDU05, RPREFTL, RPREFTP, RPRELAP, RPRELAX, RPRELCT, RPRELRU, RPRHDL, RPRLNAG, RPRLNEX, RPRLODE, RPRLORC, RPRLORE, RPRLSUM, RPRPNPT, RPRRECD, RPRRECN, RPRSAWD, RPRSBPR, RPRSTCR, RPRTIVC, RPRTIVI, RPRTIVR, RPRVABN, RRRAREQ, RRREXIT, RRRTRAN, RSRDSCP, RSRENRL, RSRPCOL

SADA3202, SADA3203, SADA3204, SADA3205, SADA3206, SADAFLEX, SADAPRNT, SAPADMS, SAPAMAL, SARI89U, SARACTM, SARADMS, SARAMAL, SARAMAS, SARAMCV, SARAMDP, SARAMXF, SARBDNS, SARDCBT, SARDCSN, SAREMAL, SARETBL, SARETMT, SARETPG, SARRATE, SATAMCS, SCRBLT, SCROIMS, SCRRIMS, SCTC1500, SCTC2000, SCTC3000, SCTD0600, SETH1000, SERADAL, SERCBREC, SERCCRC, SERLOAD, SERPSRC, SERSAREC, SERSBREC, SERSDREC, SERSEREC, SERSIREC, SERSMREC, SERSPREC, SERSVRC, SERSXREC, SERXBREC, SERXCRC, SERXEREC, SERXFREC, SFPAGRD, SFPBLCK, SFPCCREQ, SFPENRL, SFPFAUD, SFPFREQ, SFPREGS, SFPWAIT, SFRENRL, SFRFASC, SFRFEES, SFRHCNT, SFRLINK, SFRNOWD, SFRNSLC, SFRPINI, SFRRGAM, SFRRNOP, SFRSCHD, SFRSLST, SFRSSCR, SFRMST, SFRWDL, SGPBLCK, SGPCOOP, SGPHOLD, SGPSTDN, SGRCHRT, SGRKNOW, SGRSTDN, SGRVETN, SHPTAEQ, SHPTRTC, SHRASTD, SHRCATT, SHRCGPA, SHRCIPC, SHRCOMM, SHRCONV, SHRDEGS, SHRDEGV, SHREDII, SHREDIP, SHREDIR, SHREDIY, SHRETRP, SHRGPA, SHRGRDE, SHRIACT, SHRIAGE, SHRICIP, SHRIETH, SHRIGRS, SHRIPDS, SHRIQUS, SHRIRES, SHRPREV, SHRROLL, SHRRPTS, SHRTAEQ, SHRTECA, SHRTPOP, SHRTRTC, SHRTYPE, SIPASGN, SIRASGO, SIRCTAL, SIRTRAL, SLPHOUS, SLRBACS, SLRDADD, SLRFASM, SLRHLST, SLRROLL, SLRSCHD, SLRSCHD, SLRSCHD, SMCPCRG, SMRBCMP, SMRCMPL, SMRCRLT, SMRRLST, SOAIDEN, SOPAPPT, SOPLCCV, SOPLCPG, SOPSATS, SORAINF, SORCPLN, SOREMA, SORHSRP, SORLCHG, SORPCSM, SORPGEO, SORSBSM, SORSSEO, SPRDIR, SRREMA, SRRENH, SRRENRL, SRRINQR, SRRPREL, SRRSRIN, SRTLLOAD, SRTPURG, SSPMEE, SSPRDEF, SSPROLL, SSPSCHD, SSRATSQ, SSRRESV, SSRROLL, SSRSCMT, SSRSCPR, SSRSCRM, SSRSCUP, SSRSECT, SSRTALY, SSRUSEC, SURDELT, SURLOAD

TFRBILL, TFRDETL, TFRATE, TFRFND, TGPBILL, TGPHOLD, TGRAGES, TGRAPPL, TGRCDL, TGRCL, TGRCOLC, TGRCSHR, TGRDELI, TGRDETC, TGRFEED, TGRMISC, TGRCON, TGRRCPT, TGRUNAP, TRRAGES, TRRAPPL, TRRCOLL, TRRRCON, TRRUNAP, TRRUNPL, TSP1098, TSPISTA, TSPISTT, TSRI098, TSRTOT, TSRCBIL, TSRETL, TSRLATE, TSRLBOX, TSRRFND, TSRROLL, TSRSSUM, TSRTBIL, TSRTAF, TSRTSUM, TVPREQA, TVRCRD

GORCCOL

Capture Table	Capture Columns
GOREMAL	GOREMAL_EMAIL_ADDRESS GOREMAL_PREFERRED_IND GOREMAL_STATUS_IND
GORIROL	GORIROL_ROLE GORIROL_ROLE_GROUP

Capture Table**Capture Columns**

SPBPERS

SPBPERS_BIRTH_DATE
 SPBPERS_LEGAL_NAME
 SPBPERS_NAME_PREFIX
 SPBPERS_NAME_SUFFIX
 SPBPERS_PREF_FIRST_NAME
 SPBPERS_SEX
 SPBPERS_SSN

SPRADDR

SPRADDR_ATYP_CODE
 SPRADDR_CITY
 SPRADDR_CNTY_CODE
 SPRADDR_NATN_CODE
 SPRADDR_STATUS_IND
 SPRADDR_STAT_CODE
 SPRADDR_STREET_LINE1
 SPRADDR_STREET_LINE2
 SPRADDR_STREET_LINE3
 SPRADDR_ZIP

SPRIDEN

SPRIDEN_CHANGE_IND
 SPRIDEN_ENTITY_IND
 SPRIDEN_FIRST_NAME
 SPRIDEN_LAST_NAME
 SPRIDEN_MI

SPRTELE

SPRTELE_PHONE_AREA
 SPRTELE_PHONE_EXT
 SPRTELE_PHONE_NUMBER

GORCRUL**Capture Table****Capture Rule**

SPRIDEN

SPRIDEN_CHANGE_IND is NULL
 SPRIDEN_ENTITY_IND IN ('P')

GORCMDD

Common Matching Data Dictionary Table

Table	Column	Element	Max. Lnth.	Over-ride Lnth.	Allow Neg. Lnth.	On-line Ind.	Req. Element
SPRIDEN	SPRIDEN_ID	ID	9	Y	Y	Y	N
SPRIDEN	SPRIDEN_SEARCH_LAST_NAME	Last Name/ Non-Person Name	60	Y	N	Y	Y
SPRIDEN	SPRIDEN_SEARCH_FIRST_NAME	First Name	15	Y	N	Y	N
SPRIDEN	SPRIDEN_SEARCH_MI	Middle Name	15	Y	N	Y	N
SPRADDR	SPRADDR_STREET_LINE1	Street Line 1	30	Y	N	Y	N
SPRADDR	SPRADDR_CITY	City	20	Y	N	Y	N
SPRADDR	SPRADDR_STAT_CODE	State/ Province	3	N	N	Y	N
SPRADDR	SPRADDR_ZIP	Zip/Postal Code	10	Y	N	Y	N
SPRADDR	SPRADDR_NATN_CODE	Nation	5	N	N	Y	N
SPRADDR	SPRADDR_CNTY_CODE	County	5	N	N	Y	N
SPRTELE	SPRTELE_PHONE_AREA	Telephone Area Code	3	Y	N	Y	N
SPRTELE	SPRTELE_PHONE_NUMBER	Telephone Number	7	Y	N	Y	N
SPBPERS	SPBPERS_SSN	SSN/SIN/ TIN	9	Y	Y	Y	N
SPBPERS	SPBPERS_BIRTH_DAY	Date of Birthday	2	N	N	Y	N
SPBPERS	SPBPERS_BIRTH_MON	Date of Birth Month	2	N	N	Y	N

GORCMDD**Common Matching Data Dictionary Table**

Table	Column	Element	Max. Lnth.	Over-ride Lnth.	Allow Neg. Lnth.	On-line Ind.	Req. Element
SPBPERS	SPBPERS_BIRTH_YEAR	Date of Birth Year	4	N	N	Y	N
SPBPERS	SPBPERS_SEX	Gender	1	N	N	Y	N
GOREMAL	GOREMAL_EMAIL_ADDRESSES	Email	90	Y	N	Y	N

GORCTAB**Capture Table**

GOREMAL
 GORIROL
 SPBPERS
 SPRADDR
 SPRIDEN
 SPRTELE

GORDLUP Add-In Data Lookup Repeating Table

Lookup Name	Lookup Description	Menu Seq. #	Position Control Ind.	HR Ind.	Finance Ind.	Load Function
F_FUND	Fund Code Lookup	1	N	N	Y	BANINST1.FBKD2SS.P_GET_FUND_LOOKUP
G_ORGN	Organization Code Lookup	2	Y	Y	Y	BANINST1.GOKDSSB.P_GET_ORGN_LOOKUP
F_PROG	Program Code Lookup	4	N	N	Y	BANINST1.FBKD2SS.P_GET_PROG_LOOKUP
F_ACCT	Account Code Lookup	3	N	N	Y	BANINST1.FBKD2SS.P_GET_ACCT_LOOKUP
F_LOCN	Location Code Lookup	6	N	N	Y	BANINST1.FBKD2SS.P_GET_LOCN_LOOKUP

GORDLUP Add-In Data Lookup Repeating Table

Lookup Name	Lookup Description	Menu Seq. #	Position Control Ind.	HR Ind.	Finance Ind.	Load Function
F_ACTV	Activity Code Lookup	5	N	N	Y	BANINST1.FBKD2SS. P_GET_ACTV_LOOKUP
N_POSN	Position Lookup	7	N	Y	Y	BANINST1.NBKD2SB. P_LOOKUP_POSN
N_FISCYR	Fiscal Year Lookup	8	N	Y	Y	BANINST1.NBKD2SB. P_LOOKUP_FISCYR
N_ECLS	Employee Class Lookup	9	N	Y	Y	BANINST1.NBKD2SB. P_LOOKUP_ECLS
N_OBUD	Budget ID Lookup	10	N	N	Y	BANINST1.NBKD2SB. P_LOOKUP_OBUD
N_OBPH	Budget Phase Lookup	11	N	N	Y	BANINST1.NBKD2SB. P_LOOKUP_OBPH
N_EARN	Earnings Lookup	12	N	Y	N	BANINST1.NBKD2SB. P_LOOKUP_EARN
N_BDCA	Benefit/ Deduction Lookup	13	N	Y	N	BANINST1.NBKD2SB. P_LOOKUP_BDCA

For all entries above, **Add-In Code** is *BUDGET*, **Financial Aid Indicator** is *N*, **Billesh Indicator** is *N*, **Alumni Indicator** is *N*, **Student Indicator** is *N*.

GORDMCL Display Mask Column Rules Table

Block Name	Column Name	Data Type	Data Length
GOVMRT_MATCH	MATCH_BIRTH_DATE	D	12
GOVMRT_MATCH	MATCH_CITY_STATE_ZIP	C	30
GOVMRT_MATCH	MATCH_COUNTY_COUNTRY	C	30
GOVMRT_MATCH	MATCH_EMAIL	C	30
GOVMRT_MATCH	MATCH_ID	C	9
GOVMRT_MATCH	MATCH_NAME	C	99
GOVMRT_MATCH	MATCH_PHONE	C	30
GOVMRT_MATCH	MATCH_SEX	C	30
GOVMRT_MATCH	MATCH_SSN	C	9

GORDMCL**Display Mask Column Rules Table**

Block Name	Column Name	Data Type	Data Length
GOVMRT_MATCH	MATCH_STREET_LINE1	C	30
GOVMRT_MATCH	MATCH_STREET_LINE2	C	30
GOVMRT_MATCH	MATCH_STREET_LINE3	C	30
GOVMRT_SUSPENSE	MATCH_BIRTH_DATE	D	12
GOVMRT_SUSPENSE	MATCH_CITY	C	30
GOVMRT_SUSPENSE	MATCH_EMAIL	C	30
GOVMRT_SUSPENSE	MATCH_ID	C	9
GOVMRT_SUSPENSE	MATCH_NAME	C	99
GOVMRT_SUSPENSE	MATCH_NATN_CODE	C	30
GOVMRT_SUSPENSE	MATCH_PHONE	C	30
GOVMRT_SUSPENSE	MATCH_SEX	C	30
GOVMRT_SUSPENSE	MATCH_SSN	C	9
GOVMRT_SUSPENSE	MATCH_STATE	C	3
GOVMRT_SUSPENSE	MATCH_STREET_LINE1	C	30
GOVMRT_SUSPENSE	MATCH_ZIP	C	9

For all entries above, **Display Object** is *GOAMTCH*, **Query Column** is null, and **Numeric Precision** is null.

GORDPRP**Step Property Repeating Table**

Code	Value	Description
REQUIRED	TRUE	TRUE
REQUIRED	FALSE	FALSE
PICTURE	WIZARD_FUND	Wizard with Fund
PICTURE	WIZARD_BOOK	Wizard holding Book
PICTURE	WIZARD_ORGN	Wizard with Organization
MULTISELECT	TRUE	TRUE
MULTISELECT	FALSE	FALSE
FINDDISPLAYED	TRUE	TRUE
FINDDISPLAYED	FALSE	FALSE
PICTURE	WIZARD_QUESTION	Wizard with question marks
PICTURE	WIZARD_EXCLAM	Wizard with exclamation points
PICTURE	WIZARD_ACCT	Wizard with Account
PICTURE	WIZARD_PROG	Wizard with Program
PICTURE	WIZARD_LOCN	Wizard with Location
PICTURE	WIZARD_ACTV	Wizard with Activity
PICTURE	WIZARD_FLAG	Wizard holding a Finish Flag

GORDPRP**Step Property Repeating Table**

Code	Value	Description
PICTURE	WIZARD_CALENDAR	Wizard holding a calendar
PICTURE	WIZARD_CHART	Wizard behind a chart
PICTURE	WIZARD_BLOCK	Wizard with stack of blocks
PICTURE	WIZARD_AMOUNT	Wizard with money bags
PICTURE	WIZARD_EXCEL	Wizard holding spreadsheets

GORDSTE**Wizard Step Repeating Table**

Add-In Code	Wizard Name	Step Name	Step Type
BUDGET	DOWNLOAD	F_ACCT_FBBBLIN	ONEWIN
BUDGET	DOWNLOAD	F_ACCT_FGBOPAL	ONEWIN
BUDGET	DOWNLOAD	F_ACCT_FRRGRNL	ONEWIN
BUDGET	DOWNLOAD	F_ACTV_FBBBLIN	ONEWIN
BUDGET	DOWNLOAD	F_ACTV_FGBOPAL	ONEWIN
BUDGET	DOWNLOAD	F_ACTV_FRRGRNL	ONEWIN
BUDGET	DOWNLOAD	F_AMTTYPER_FBBBLIN	ONEWIN
BUDGET	DOWNLOAD	F_AMTTYPER_FGBOPAL	ONEWIN
BUDGET	DOWNLOAD	F_AMTTYPER_FRRGRNL	ONEWIN
BUDGET	DOWNLOAD	F_BUDGETDEV	OPTION
BUDGET	DOWNLOAD	F_BUDGID	ONEWIN
BUDGET	DOWNLOAD	F_BUDGPH	ONEWIN
BUDGET	DOWNLOAD	F_CMT_TYPE	OPTION
BUDGET	DOWNLOAD	F_COAS	ONEWIN
BUDGET	DOWNLOAD	F_FISCPERIOD	ONEWIN
BUDGET	DOWNLOAD	F_FISCYEAR	ONEWIN
BUDGET	DOWNLOAD	F_FUND_FBBBLIN	ONEWIN
BUDGET	DOWNLOAD	F_FUND_FGBOPAL	ONEWIN
BUDGET	DOWNLOAD	F_FUND_FRRGRNL	ONEWIN
BUDGET	DOWNLOAD	F_GRCODE	ONEWIN
BUDGET	DOWNLOAD	F_GRPERIOD	ONEWIN
BUDGET	DOWNLOAD	F_GRYEAR	ONEWIN
BUDGET	DOWNLOAD	F_LOCN_FBBBLIN	ONEWIN
BUDGET	DOWNLOAD	F_LOCN_FGBOPAL	ONEWIN
BUDGET	DOWNLOAD	F_LOCN_FRRGRNL	ONEWIN
BUDGET	DOWNLOAD	F_ORGN_FBBBLIN	ONEWIN
BUDGET	DOWNLOAD	F_ORGN_FGBOPAL	ONEWIN
BUDGET	DOWNLOAD	F_ORGN_FRRGRNL	ONEWIN
BUDGET	DOWNLOAD	F_PROG_FBBBLIN	ONEWIN
BUDGET	DOWNLOAD	F_PROG_FGBOPAL	ONEWIN
BUDGET	DOWNLOAD	F_PROG_FRRGRNL	ONEWIN
BUDGET	DOWNLOAD	F_REQ_COMPLETE	TEXT
BUDGET	DOWNLOAD	G_TABLE_NAME	OPTION
BUDGET	DOWNLOAD	N_BUDGID	ONEWIN

GORDSTE**Wizard Step Repeating Table**

Add-In Code	Wizard Name	Step Name	Step Type
BUDGET	DOWNLOAD	N_BUDGPH	ONEWIN
BUDGET	DOWNLOAD	N_COAS	ONEWIN
BUDGET	DOWNLOAD	N_ECLS	ONEWIN
BUDGET	DOWNLOAD	N_FISCYR	ONEWIN
BUDGET	DOWNLOAD	N_JOBS	OPTION
BUDGET	DOWNLOAD	N_JOBS_COAS	ONEWIN
BUDGET	DOWNLOAD	N_JOBS_COLS	TWOWIN
BUDGET	DOWNLOAD	N_JOBS_DATE	FREEFORMAT
BUDGET	DOWNLOAD	N_JOBS_INFO	OPTION
BUDGET	DOWNLOAD	N_ORGN	ONEWIN
BUDGET	DOWNLOAD	N_SOURCE	OPTION
BUDGET	UPLOAD	F_UPLOAD_BOOK	WKSHEET
BUDGET	UPLOAD	F_UPLOAD_BUDGID	ONEWIN
BUDGET	UPLOAD	F_UPLOAD_COAS	ONEWIN
BUDGET	UPLOAD	F_UPLOAD_FINISH	TEXT
BUDGET	UPLOAD	F_UPLOAD_HEADERS	ONEWIN
BUDGET	UPLOAD	F_UPLOAD_MAPPING	COLUMNMAP
BUDGET	UPLOAD	F_UPLOAD_MAPPING_DUR	COLUMNMAP
BUDGET	UPLOAD	F_UPLOAD_PERM	OPTION
BUDGET	UPLOAD	F_UPLOAD_PHASE	ONEWIN
BUDGET	UPLOAD	F_UPLOAD_SEQNO	TEXT
BUDGET	UPLOAD	G_UPLOAD_TABLE	OPTION
BUDGET	UPLOAD	N_UPLD_BUDGID	ONEWIN
BUDGET	UPLOAD	N_UPLD_BUDGPH	ONEWIN
BUDGET	UPLOAD	N_UPLD_COAS	ONEWIN
BUDGET	UPLOAD	N_UPLD_FINISH	TEXT
BUDGET	UPLOAD	N_UPLD_FISCYR	ONEWIN
BUDGET	UPLOAD	N_UPLD_FTOT_BOOK	WKSHEET
BUDGET	UPLOAD	N_UPLD_FTOT_MAP	COLUMNMAP
BUDGET	UPLOAD	N_UPLD_HDERS_WARNING	TEXT
BUDGET	UPLOAD	N_UPLD_PLBD_BOOK	WKSHEET
BUDGET	UPLOAD	N_UPLD_PLBD_MAP	COLUMNMAP
BUDGET	UPLOAD	N_UPLD_PLBD_MAP_NOFIN	COLUMNMAP
BUDGET	UPLOAD	N_UPLD_PTOT_BOOK	WKSHEET
BUDGET	UPLOAD	N_UPLD_PTOT_MAP	COLUMNMAP
BUDGET	UPLOAD	N_UPLD_RTOT_BOOK	WKSHEET
BUDGET	UPLOAD	N_UPLD_RTOT_MAP	COLUMNMAP
BUDGET	VALIDATION	F_VAL_BOOK	WKSHEET
BUDGET	VALIDATION	F_VAL_BUDGID	ONEWIN
BUDGET	VALIDATION	F_VAL_COAS	ONEWIN
BUDGET	VALIDATION	F_VAL_FINISH	TEXT
BUDGET	VALIDATION	F_VAL_HEADERS	ONEWIN
BUDGET	VALIDATION	F_VAL_MAPPING	COLUMNMAP
BUDGET	VALIDATION	F_VAL_MAPPING_DUR	COLUMNMAP
BUDGET	VALIDATION	F_VAL_PERM	OPTION

GORDSTE**Wizard Step Repeating Table**

Add-In Code	Wizard Name	Step Name	Step Type
BUDGET	VALIDATION	F_VAL_PHASE	ONEWIN
BUDGET	VALIDATION	F_VAL_SEQNO	TEXT
BUDGET	VALIDATION	G_VAL_TABLE	OPTION
BUDGET	VALIDATION	N_VAL_BUDGID	ONEWIN
BUDGET	VALIDATION	N_VAL_BUDGPH	ONEWIN
BUDGET	VALIDATION	N_VAL_COAS	ONEWIN
BUDGET	VALIDATION	N_VAL_FINISH	TEXT
BUDGET	VALIDATION	N_VAL_FISCYR	ONEWIN
BUDGET	VALIDATION	N_VAL_FTOT_BOOK	WKSHEET
BUDGET	VALIDATION	N_VAL_FTOT_MAP	COLUMNMAP
BUDGET	VALIDATION	N_VAL_HDERS_WARNING	TEXT
BUDGET	VALIDATION	N_VAL_PLBD_BOOK	WKSHEET
BUDGET	VALIDATION	N_VAL_PLBD_MAP	COLUMNMAP
BUDGET	VALIDATION	N_VAL_PLBD_MAP_NOFIN	COLUMNMAP
BUDGET	VALIDATION	N_VAL_PTOT_BOOK	WKSHEET
BUDGET	VALIDATION	N_VAL_PTOT_MAP	COLUMNMAP
BUDGET	VALIDATION	N_VAL_RTOT_BOOK	WKSHEET
BUDGET	VALIDATION	N_VAL_RTOT_MAP	COLUMNMAP
BUDGET	UPLOAD	N_UPLD_SGRP	ONEWIN
BUDGET	VALIDATION	N_VAL_SGRP	ONEWIN

GORDSTP**Step Type Property Repeating Table**

Step Property Type	Step Property Code	Locked	Required
COLUMNMAP	REQUIREDCOLUMNS	Y	Y
COLUMNMAP	REQUIRED	Y	Y
ONEWIN	FINDDISPLAYED	Y	Y
TWOWIN	FINDDISPLAYED	Y	Y
WKSHEET	CAPTION	N	Y
WKSHEET	PICTURE	N	N
WKSHEET	SELECTIONPROC	Y	Y
WKSHEET	STORINGPROC	Y	Y
WKSHEET	REQUIRED	Y	Y
WKSHEET	MULTISELECT	Y	Y
TEXT	CAPTION_1	N	N
TEXT	CAPTION_2	N	N
TEXT	CAPTION_3	N	N
TEXT	PICTURE	N	N
FREEFORMAT	PICTURE	N	N
FREEFORMAT	CAPTION	N	Y
FREEFORMAT	SELECTIONPROC	Y	Y

GORDSTP**Step Type Property Repeating Table**

Step Property Type	Step Property Code	Locked	Required
FREEFORMAT	TEXTWIDTH	Y	Y
FREEFORMAT	TEXTHEIGHT	Y	Y
FREEFORMAT	STORINGPROC	Y	Y
TEXT	CAPTION_1_HT	N	N
FREEFORMAT	REQUIRED	Y	Y
FREEFORMAT	VALIDATIONPROC	Y	Y
TEXT	CAPTION_2_HT	N	N
TEXT	CAPTION_3_HT	N	N
TEXT	CAPTION_1_TOP	N	N
TEXT	CAPTION_2_TOP	N	N
TEXT	CAPTION_3_TOP	N	N
COLUMNMAP	POPULATIONPROC	Y	Y
ONEWIN	CAPTION	N	Y
ONEWIN	STORINGPROC	Y	Y
ONEWIN	REQUIRED	Y	Y
ONEWIN	POPULATIONPROC	Y	Y
ONEWIN	BOUNDCOLUMNS	Y	Y
ONEWIN	SELECTIONPROC	Y	Y
OPTION	OPTION_1	N	N
ONEWIN	PICTURE	N	N
OPTION	OPTION_2	N	N
OPTION	OPTION_3	N	N
OPTION	OPTION_4	N	N
OPTION	OPTION_5	N	N
OPTION	OPTION_6	N	N
OPTION	OPTION_7	N	N
OPTION	OPTION_1_KEY	N	N
OPTION	OPTION_2_KEY	N	N
OPTION	OPTION_3_KEY	N	N
OPTION	OPTION_4_KEY	N	N
OPTION	OPTION_5_KEY	N	N
OPTION	OPTION_6_KEY	N	N
OPTION	OPTION_7_KEY	N	N
OPTION	CAPTION	N	Y
OPTION	PICTURE	N	N
OPTION	STORINGPROC	Y	Y
OPTION	SELECTIONPROC	Y	Y
ONEWIN	COLUMNHEADERS	Y	Y
OPTION	OPTION_0	N	N

GORDSTP**Step Type Property Repeating Table**

Step Property Type	Step Property Code	Locked	Required
OPTION	OPTION_O_KEY	N	N
TWOWIN	BOUNDCOLUMNS	Y	Y
TWOWIN	CAPTION	N	Y
TWOWIN	PICTURE	N	N
TWOWIN	COLUMNHEADERS	Y	Y
TWOWIN	POPULATIONPROC	Y	Y
TWOWIN	STORINGPROC	Y	Y
TWOWIN	SELECTIONPROC	Y	Y
TWOWIN	REQUIRED	Y	Y
ONEWIN	MULTISELECT	Y	Y
OPTION	REQUIRED	Y	Y
COLUMNMAP	CAPTION	N	Y
COLUMNMAP	SELECTIONPROC	Y	Y
COLUMNMAP	COLUMNHEADERS	Y	Y
COLUMNMAP	STORINGPROC	Y	Y

GORDWIZ**Add-In Wizard Association Table**

Wizard Name	Description	Add-In Code	Menu Seq.	Fin. Aid	Position Control	Billcsh
DOWNLOAD	Download Wizard	BUDGET	1	N	Y	N
VALIDATION	Validation Wizard	BUDGET	2	N	Y	N
UPLOAD	Upload Wizard	BUDGET	3	N	Y	N

Wizard Name	HR	Fin- ance	Ad- vance.	Student	Finish Function
DOWNLOAD	Y	Y	N	N	BANINST1.GOKDSSB.P_FINISH_DOWNLOAD
VALIDATION	Y	Y	N	N	BANINST1.GOKDSSB.P_FINISH_VALIDATION
UPLOAD	Y	Y	N	N	BANINST1.GOKDSSB.P_FINISH_UPLOAD

Wizard Name	Next Function	Unload Function
DOWNLOAD	BANINST1.GOKDSSB.P_NEXT_DOWNLOAD	BANINST1.GOKDSSB.P_UNLOAD_BUDGET
VALIDATION	BANINST1.GOKDSSB.P_NEXT_VALIDATION	BANINST1.GOKDSSB.P_UNLOAD_BUDGET
UPLOAD	BANINST1.GOKDSSB.P_NEXT_UPLOAD	BANINST1.GOKDSSB.P_UNLOAD_BUDGET

GOREQNM**Event Queue Name Definition Table**

Event Code	Group Code	Target System Code	Status
CHANGE_PERSON_NAME	CHGNAME	PIPELINE	I
CHANGE_PIN	PINCHANGE	PIPELINE	I
APPLICATION_RECEIVED	ID-MESSAGE	PIPELINE	I
GRADE_CHANGE	CHGGRADE	PIPELINE	I
GRADE_ROLL	GRADEROLL	PIPELINE	I
CHANGE_PERSON_ID	CHGPERSID	PIPELINE	I
CHANGE_MAJOR	CHGMAJOR	PIPELINE	I
SECTION_CANCELLED	ID-MESSAGE	PIPELINE	I
ADD_REGISTRATION	ADDREG	PIPELINE	I
ADD_SECTION	ADDSECTION	PIPELINE	I
PAFCHANGE	PAFCHANGE	WORKFLOW	I
NEWGIFT	NEWGIFT	WORKFLOW	I
WITHDRAWSTUDENT	WDSTUDENT	WORKFLOW	I
PSWDCHANGE	PSWDCHANGE	WORKFLOW	I
GRADECHG	GRADECHG	WORKFLOW	I
DOCAPPROVE	DOCAPPROVE	WORKFLOW	I
EDOCUMENT	EDOCUMENT	WORKFLOW	I
FAWITHDRAW	FAWITHDRAW	WORKFLOW	I
DROP_REGISTRATION	DROPREG	PIPELINE	I
ADD_NEW_STU_USER	ADDSTUDENT	PIPELINE	I
ADD_TEACH_ASSIGN	ADDTCHASG	PIPELINE	I
DELETE_TEACH_ASSIGN	DELTCHASG	PIPELINE	I
CHANGE_SECTION_NUM	CHGSECNUM	PIPELINE	I
CHANGE_COURSE_TITLE	CHGTITLE	PIPELINE	I
CHANGE_COURSE_DEPT	CHGDEPT	PIPELINE	I
DELETE_SECTION	DELSECTION	PIPELINE	I
ADD_NEW_FAC_USER	ADDFACULTY	PIPELINE	I
ADD_HOLD	ADDHOLD	PIPELINE	I
END_TERM	ENDTERM	PIPELINE	I
ADD_TERM	ADDTERM	PIPELINE	I
EMAIL_UPDATE	EMAILUPD	PIPELINE	A
EMAIL_INSERT	EMAILINS	PIPELINE	A
ICASSIGN	ICASSIGN	INTCOMP	I
ICENROLL	ICENROLL	INTCOMP	I
ICPERSON	ICPERSON	INTCOMP	I
ICSECTION	ICSECTION	INTCOMP	I

GOREQNM**Event Queue Name Definition Table**

Event Code	Group Code	Target System Code	Status
ICTERM	ICTERM	INTCOMP	I
CHANGE_MEETINGS	CHANGEMEET	PIPELINE	I
CHANGE_EMAIL_ID	CHGEMAILID	PIPELINE	I
CHANGE_SCHEDULE_CODE	CHGSCHCODE	PIPELINE	I
LDITERM	LDITERM	LDI	I
LDIPERSON	LDIPERSON	LDI	I
LDICOURSE	LDICOURSE	LDI	I
LDISECTION	LDISECTION	LDI	I
LDICOLLEGE	LDICOLLEGE	LDI	I
LDIDEPT	LDIDEPT	LDI	I
LDIXLGRP	LDIXLGRP	LDI	I
LDIXLMEM	LDIXLMEM	LDI	I
LDIENROLL	LDIENROLL	LDI	I
LDIASSIGN	LDIASSIGN	LDI	I

GORFDPI**FGAC PII Policy Table**

Table Name	Column Name	Active	Driver SQL
SPRIDEN	SPRIDEN_PIDM	N	gokfgac.f_find_pii_domain

GORRSQL**SQL Process Rules Table**

Process Code	Rule Code	Seq. No.	Active	Start Date	Select From	Select Value
CARDHOLDER_ROLES	ALUMNUS	1	Y	19-OCT-05	FROM	SELECT
CARDHOLDER_ROLES	EMPLOYEE	1	Y	19-OCT-05	FROM	SELECT
CARDHOLDER_ROLES	STUDENT	1	Y	19-OCT-05	FROM	SELECT
HOUSING_ELIGIBILITY	STUDENT_ENROLLED	1	Y	19-OCT-05	FROM	SELECT
INTCOMP	ALUMNI	1	Y	27-OCT-05	FROM	SELECT
INTCOMP	APPACCEPT	1	Y	27-OCT-05	FROM	SELECT
INTCOMP	APPLICANT	1	Y	27-OCT-05	FROM	SELECT
INTCOMP	DEVELOPMENTOFFICER	1	Y	27-OCT-05	FROM	SELECT
INTCOMP	EMPLOYEE	1	Y	27-OCT-05	FROM	SELECT

GORRSQL

SQL Process Rules Table

Process Code	Rule Code	Seq. No.	Active	Start Date	Select From	Select Value
INTCOMP	FINANCE	1	Y	27-OCT-05	FROM	SELECT
INTCOMP	FRIENDS	1	Y	27-OCT-05	FROM	SELECT
INTCOMP	INTACCEPT	1	Y	27-OCT-05	FROM	SELECT
INTCOMP	PROSPECT	1	Y	27-OCT-05	FROM	SELECT
INTCOMP	STUDENT	1	Y	27-OCT-05	FROM	SELECT
INTCOMP	STUDENT	2	N	27-OCT-05	FROM	SELECT
INTCOMP	FACULTY	1	Y	27-OCT-05	FROM	SELECT
INTCOMP	FACULTY	2	N	27-OCT-05	FROM	SELECT

For all entries above, **Validated Indicator** is *Y*, and **End Date** is null. The **Where Clause** and **Parsed SQL** values for each row are shown in the tables below.

Rule Code	Seq. No.	Where Clause
ALUMNUS	1	<pre> SELECT DISTINCT aprcatg_pidm FROM spriden, atvdonr, aprcatg WHERE spriden_entity_ind = 'P' AND spriden_change_ind IS NULL AND aprcatg_pidm = spriden_pidm AND atvdonr_code = aprcatg_donr_code AND atvdonr_alum_ind = 'Y' </pre>
EMPLOYEE	1	<pre> SELECT pebempl_pidm FROM pebempl WHERE NVL(pebempl_term_date, TRUNC(SYSDATE) + 1) > TRUNC(SYSDATE) AND NVL(pebempl_loa_beg_date, TRUNC(SYSDATE) - 1) < TRUNC(SYSDATE) AND pebempl_empl_status IN ('A', 'F', 'P') </pre>

Rule Code	Seq. No.	Where Clause
STUDENT	1	<pre> SELECT sgbstdn_pidm FROM sgbstdn a, stvstst WHERE a.sgbstdn_stst_code = stvstst_code AND stvstst_reg_ind = 'Y' AND a.sgbstdn_term_code_eff = (SELECT MAX (b.sgbstdn_term_code_eff) FROM sgbstdn b WHERE b.sgbstdn_pidm = a.sgbstdn_pidm AND b.sgbstdn_term_code_eff <= :TERM) </pre>
STUDENT_ ENROLLED	1	<pre> SELECT sfbetrm_pidm FROM stvests, sfbetrm WHERE sfbetrm_term_code = :TERM AND stvests_code = sfbetrm_ests_code AND stvests_wd_ind = 'N' </pre>
ALUMNI	1	<pre> SELECT DISTINCT aprcatg_pidm FROM aprcatg WHERE EXISTS (SELECT 'X' FROM atvdonr WHERE atvdonr_code = aprcatg_donr_code AND atvdonr_alum_ind = 'Y') </pre>
APPACCEPT	1	<pre> SELECT DISTINCT sarappd_pidm FROM sarappd WHERE sarappd_apdc_code IN (SELECT stvapdc_code FROM stvapdc WHERE stvapdc_stdn_acc_ind = 'Y') </pre>

Rule Code	Seq. No.	Where Clause
APPLICANT	1	<pre> SELECT DISTINCT p.saradap_pidm FROM saradap p WHERE NOT EXISTS (SELECT 'Y' FROM sarappd WHERE sarappd_pidm = p.saradap_pidm AND sarappd_term_code_entry = p.saradap_term_code_entry AND sarappd_appl_no = p.saradap_appl_no AND (sarappd_apdc_code IN (SELECT stvapdc_code FROM stvapdc WHERE stvapdc_inst_acc_ind = 'Y' AND stvapdc_stdn_acc_ind IS NULL) OR sarappd_apdc_code IN (SELECT stvapdc_code FROM stvapdc WHERE stvapdc_stdn_acc_ind IS NOT NULL))) AND NOT EXISTS (SELECT 'Y' FROM saradap s WHERE s.saradap_pidm = p.saradap_pidm AND s.saradap_term_code_entry = p.saradap_term_code_entry AND s.saradap_level_code = p.saradap_level_code AND EXISTS (SELECT 'Y' FROM sarappd WHERE sarappd_pidm = s.saradap_pidm AND sarappd_term_code_entry = s.saradap_term_code_entry AND sarappd_appl_no = s.saradap_appl_no AND (sarappd_apdc_code IN (SELECT stvapdc_code FROM stvapdc WHERE stvapdc_inst_acc_ind = 'Y' AND stvapdc_stdn_acc_ind IS NULL) OR sarappd_apdc_code IN (SELECT stvapdc_code FROM stvapdc WHERE stvapdc_stdn_acc_ind IS NOT NULL)))) </pre>
DEVELOPMENT OFFICER	1	<pre> SELECT DISTINCT twgrrrole_pidm FROM twgrrrole WHERE twgrrrole_role = 'DEVELOPMENTOFFICER' </pre>

Rule Code	Seq. No.	Where Clause
EMPLOYEE	1	<pre> SELECT pebempl_pidm FROM pebempl, gtvsdax WHERE gtvsdax_external_code(+) = pebempl_ecls_code AND gtvsdax_internal_code_group(+) = 'INTCOMP' AND gtvsdax_internal_code(+) = 'LDIEMPEX' GROUP BY pebempl_pidm HAVING COUNT(gtvsdax_external_code) = 0 </pre>
FINANCE	1	<pre> SELECT DISTINCT gobeacc_pidm FROM gobeacc, fobprof WHERE fobprof_user_id = gobeacc_username AND fobprof_web_access_ind = 'Y' </pre>
FRIENDS	1	<pre> SELECT DISTINCT aprcatg_pidm FROM aprcatg WHERE EXISTS (SELECT 'X' FROM atvdonr WHERE atvdonr_code = aprcatg_donr_code AND atvdonr_frnd_ind = 'Y') </pre>
INTACCEPT	1	<pre> SELECT DISTINCT sarappd_pidm FROM sarappd, saradap WHERE saradap_pidm = sarappd_pidm AND saradap_term_code_entry = sarappd_term_code_entry AND saradap_appl_no = sarappd_appl_no AND sarappd_apdc_code IN (SELECT stvapdc_code FROM stvapdc WHERE stvapdc_inst_acc_ind = 'Y' AND stvapdc_stdn_acc_ind IS NULL) AND NOT EXISTS (SELECT 'Y' FROM saradap s WHERE s.saradap_pidm = sarappd_pidm AND s.saradap_lvl_code = saradap_lvl_code AND s.saradap_term_code_entry = sarappd_term_code_entry AND s.saradap_appl_no = sarappd_appl_no AND EXISTS (SELECT 'Y' FROM sarappd p WHERE p.sarappd_pidm = s.saradap_pidm AND p.sarappd_term_code_entry = s.saradap_term_code_entry AND p.sarappd_appl_no = s.saradap_appl_no AND p.sarappd_apdc_code IN (SELECT stvapdc_code FROM stvapdc WHERE stvapdc_stdn_acc_ind IS NOT NULL))) </pre>

Rule Code	Seq. No.	Where Clause
PROSPECT	1	<pre> SELECT DISTINCT srbreocr_pidm FROM srbreocr WHERE NOT EXISTS (SELECT 'Y' FROM saradap WHERE saradap_pidm = srbreocr_pidm AND saradap_term_code_entry = srbreocr_term_code AND saradap_levl_code = srbreocr_levl_code) </pre>
STUDENT	1	<pre> SELECT DISTINCT a.sgbstdn_pidm FROM sgbstdn a, stvstst WHERE a.sgbstdn_stst_code = stvstst_code AND stvstst_reg_ind = 'Y' AND a.sgbstdn_term_code_eff IN (SELECT MAX(b.sgbstdn_term_code_eff) FROM sgbstdn b, sobterm c WHERE b.sgbstdn_pidm = a.sgbstdn_pidm AND b.sgbstdn_term_code_eff <= c.sobterm_term_code AND sobterm_profile_send_ind = 'Y' GROUP BY c.sobterm_term_code) </pre>
STUDENT	2	<pre> SELECT DISTINCT sfrstcr_pidm FROM sfrstcr WHERE sfrstcr_term_code IN (SELECT sobterm_term_code FROM sobterm WHERE sobterm_profile_send_ind = 'Y') </pre>
FACULTY	1	<pre> SELECT DISTINCT a.sibinst_pidm FROM sibinst a, stvfcst WHERE a.sibinst_term_code_eff IN (SELECT MAX(b.sibinst_term_code_eff) FROM sibinst b, sobterm c WHERE b.sibinst_pidm = a.sibinst_pidm AND b.sibinst_term_code_eff <= c.sobterm_term_code AND sobterm_profile_send_ind = 'Y' GROUP BY c.sobterm_term_code) AND a.sibinst_fcst_code = stvfcst_code AND stvfcst_active_ind = 'A' </pre>
FACULTY	2	<pre> SELECT DISTINCT sirasgn_pidm FROM sirasgn WHERE sirasgn_term_code IN (SELECT sobterm_term_code FROM sobterm WHERE sobterm_profile_send_ind = 'Y') </pre>

Rule Code	Seq. No.	Parsed SQL
ALUMNUS	1	<pre> SELECT DISTINCT aprcatg_pidm FROM spriden, atvdonr, aprcatg WHERE spriden_entity_ind = 'P' AND spriden_change_ind IS NULL AND aprcatg_pidm = spriden_pidm AND atvdonr_code = aprcatg_donr_code AND atvdonr_alum_ind = 'Y' </pre>
EMPLOYEE	1	<pre> SELECT pebempl_pidm FROM pebempl WHERE NVL(pebempl_term_date, TRUNC(SYSDATE) + 1) > TRUNC(SYSDATE) AND NVL(pebempl_loa_beg_date, TRUNC(SYSDATE) - 1) < TRUNC(SYSDATE) AND pebempl_empl_status IN ('A', 'F', 'P') </pre>
STUDENT	1	<pre> SELECT sgbstdn_pidm FROM sgbstdn a, stvstst WHERE a.sgbstdn_stst_code = stvstst_code AND stvstst_reg_ind = 'Y' AND a.sgbstdn_term_code_eff = (SELECT MAX (b.sgbstdn_term_code_eff) FROM sgbstdn b WHERE b.sgbstdn_pidm = a.sgbstdn_pidm AND b.sgbstdn_term_code_eff <= :TERM) </pre>
STUDENT_ ENROLLED	1	<pre> SELECT sfbetrm_pidm FROM stvests, sfbetrm WHERE sfbetrm_term_code = :TERM AND stvests_code = sfbetrm_ests_code AND stvests_wd_ind = 'N' </pre>
ALUMNI	1	<pre> SELECT DISTINCT aprcatg_pidm FROM aprcatg WHERE EXISTS (SELECT 'X' FROM atvdonr WHERE atvdonr_code = aprcatg_donr_code AND atvdonr_alum_ind = 'Y') </pre>
APPACCEPT	1	<pre> SELECT DISTINCT sarappd_pidm FROM sarappd WHERE sarappd_apdc_code IN (SELECT stvapdc_code FROM stvapdc WHERE stvapdc_stdn_acc_ind = 'Y') </pre>

Rule Code	Seq. No.	Parsed SQL
APPLICANT	1	<pre> SELECT DISTINCT p.saradap_pidm FROM saradap p WHERE NOT EXISTS (SELECT 'Y' FROM sarappd WHERE sarappd_pidm = p.saradap_pidm AND sarappd_term_code_entry = p.saradap_term_code_entry AND sarappd_appl_no = p.saradap_appl_no AND (sarappd_apdc_code IN (SELECT stvapdc_code FROM stvapdc WHERE stvapdc_inst_acc_ind = 'Y' AND stvapdc_stdn_acc_ind IS NULL) OR sarappd_apdc_code IN (SELECT stvapdc_code FROM stvapdc WHERE stvapdc_stdn_acc_ind IS NOT NULL))) AND NOT EXISTS (SELECT 'Y' FROM saradap s WHERE s.saradap_pidm = p.saradap_pidm AND s.saradap_term_code_entry = p.saradap_term_code_entry AND s.saradap_levl_code = p.saradap_levl_code AND EXISTS (SELECT 'Y' FROM sarappd WHERE sarappd_pidm = s.saradap_pidm AND sarappd_term_code_entry = s.saradap_term_code_entry AND sarappd_appl_no = s.saradap_appl_no AND (sarappd_apdc_code IN (SELECT stvapdc_code FROM stvapdc WHERE stvapdc_inst_acc_ind = 'Y' AND stvapdc_stdn_acc_ind IS NULL) OR sarappd_apdc_code IN (SELECT stvapdc_code FROM stvapdc WHERE stvapdc_stdn_acc_ind IS NOT NULL)))))) </pre>
DEVELOPMENT OFFICER	1	<pre> SELECT DISTINCT twgrrole_pidm FROM twgrrole WHERE twgrrole_role = 'DEVELOPMENTOFFICER' </pre>

Rule Code	Seq. No.	Parsed SQL
EMPLOYEE	1	<pre> SELECT pebempl_pidm FROM pebempl, gtvsdax WHERE gtvsdax_external_code(+) = pebempl_ecls_code AND gtvsdax_internal_code_group(+) = 'INTCOMP' AND gtvsdax_internal_code(+) = 'LDIEMPEX' GROUP BY pebempl_pidm HAVING COUNT(gtvsdax_external_code) = 0 </pre>
FINANCE	1	<pre> SELECT DISTINCT gobeacc_pidm FROM gobeacc, fobprof WHERE fobprof_user_id = gobeacc_username AND fobprof_web_access_ind = 'Y' </pre>
FRIENDS	1	<pre> SELECT DISTINCT aprcatg_pidm FROM aprcatg WHERE EXISTS (SELECT 'X' FROM atvdonr WHERE atvdonr_code = aprcatg_donr_code AND atvdonr_frnd_ind = 'Y') </pre>
INTACCEPT	1	<pre> SELECT DISTINCT sarappd_pidm FROM sarappd, saradap WHERE saradap_pidm = sarappd_pidm AND saradap_term_code_entry = sarappd_term_code_entry AND saradap_appl_no = sarappd_appl_no AND sarappd_apdc_code IN (SELECT stvapdc_code FROM stvapdc WHERE stvapdc_inst_acc_ind = 'Y' AND stvapdc_stdn_acc_ind IS NULL) AND NOT EXISTS (SELECT 'Y' FROM saradap s WHERE s.saradap_pidm = sarappd_pidm AND s.saradap_levl_code = saradap_levl_code AND s.saradap_term_code_entry = sarappd_term_code_entry AND s.saradap_appl_no = sarappd_appl_no AND EXISTS (SELECT 'Y' FROM sarappd p WHERE p.sarappd_pidm = s.saradap_pidm AND p.sarappd_term_code_entry = s.saradap_term_code_entry AND p.sarappd_appl_no = s.saradap_appl_no AND p.sarappd_apdc_code IN (SELECT stvapdc_code FROM stvapdc WHERE stvapdc_stdn_acc_ind IS NOT NULL))) </pre>

Rule Code	Seq. No.	Parsed SQL
PROSPECT	1	<pre> SELECT DISTINCT srbreocr_pidm FROM srbreocr WHERE NOT EXISTS (SELECT 'Y' FROM saradap WHERE saradap_pidm = srbreocr_pidm AND saradap_term_code_entry = srbreocr_term_code AND saradap_lvl_code = srbreocr_lvl_code) </pre>
STUDENT	1	<pre> SELECT DISTINCT a.sgbstdn_pidm FROM sgbstdn a, stvstst WHERE a.sgbstdn_stst_code = stvstst_code AND stvstst_reg_ind = 'Y' AND a.sgbstdn_term_code_eff IN (SELECT MAX(b.sgbstdn_term_code_eff) FROM sgbstdn b, sobterm c WHERE b.sgbstdn_pidm = a.sgbstdn_pidm AND b.sgbstdn_term_code_eff <= c.sobterm_term_code AND sobterm_profile_send_ind = 'Y' GROUP BY c.sobterm_term_code) </pre>
STUDENT	2	<pre> SELECT DISTINCT sfrstcr_pidm FROM sfrstcr WHERE sfrstcr_term_code IN (SELECT sobterm_term_code FROM sobterm WHERE sobterm_profile_send_ind = 'Y') </pre>
FACULTY	1	<pre> SELECT DISTINCT a.sibinst_pidm FROM sibinst a, stvfcst WHERE a.sibinst_term_code_eff IN (SELECT MAX(b.sibinst_term_code_eff) FROM sibinst b, sobterm c WHERE b.sibinst_pidm = a.sibinst_pidm AND b.sibinst_term_code_eff <= c.sobterm_term_code AND sobterm_profile_send_ind = 'Y' GROUP BY c.sobterm_term_code) AND a.sibinst_fcst_code = stvfcst_code AND stvfcst_active_ind = 'A' </pre>
FACULTY	2	<pre> SELECT DISTINCT sirasgn_pidm FROM sirasgn WHERE sirasgn_term_code IN (SELECT sobterm_term_code FROM sobterm WHERE sobterm_profile_send_ind = 'Y') </pre>

GORSQPA**SQL Process Parameter Table**

Process Code Code	Parameter Code
CARDHOLDER_ROLES	TERM
HOUSING_ELIGIBILITY	TERM
SEVIS	PIDM
SEVIS	TERM

GORSSQL

Process	Rule	Parsed SQL Statement
IAM	IAM_GOBEACC_RULE	SELECT GOBEACC_USERNAME BANNERINB_USER FROM GOBEACC WHERE GOBEACC_PIDM =:PIDM

GTVCELG**Certification of Eligibility Table**

I-20	I-20 Information
I-94	I-94 Data
IAP-66	International Information

GTVDADD**Add-In Code Validation Table**

BUDGET	Spreadsheet Budgeting
--------	-----------------------

GTVDIRO**Directory Options Validation Table**

NAME	Name
ADDR_PR	Permanent Address
TELE_PR	Permanent Telephone
ADDR_CP	Campus Address
TELE_CP	Campus Telephone
ADDR_OF	Office Address
TELE_OF	Office Telephone
TELE_FAX	Fax Number
EMAIL	E-mail
DEPT	Employee Department
GRD_YEAR	Expected Graduation Year
COLLEGE	College Affiliation

GTVDIRO**Directory Options Validation Table**

TITLE	Employee Position Title
ADDR_HO	Home Address
CLASS_YR	Class Year
ADDR_BU	Business Address
MAIDEN	Maiden Name
TELE_BU	Business Telephone
PR_COLL	Preferred College
TELE_HO	Home Telephone

GTVDPRP**Step Property Validation Table**

REQUIREDCOLUMNS	Required Columns
SELECTIONPROC	Selection Procedure
OPTION_0	Option(0)
OPTION_1	Option(1)
OPTION_2	Option(2)
OPTION_3	Option(3)
OPTION_4	Option(4)
OPTION_5	Option(5)
OPTION_6	Option(6)
OPTION_7	Option(7)
OPTION_0_KEY	Option(0) - Key
OPTION_1_KEY	Option(1) - Key
OPTION_2_KEY	Option(2) - Key
OPTION_3_KEY	Option(3) - Key
OPTION_4_KEY	Option(4) - Key
OPTION_5_KEY	Option(5) - Key
OPTION_6_KEY	Option(6) - Key
OPTION_7_KEY	Option(7) - Key
PICTURE	Picture
POPULATIONPROC	Population Procedure
REQUIRED	Required
TEXTWIDTH	Free Format Text Width
MULTISELECT	Multiple Selections
STORINGPROC	Storing Procedure
FINDDISPLAYED	Find Displayed
TEXTHEIGHT	Free Format Text Height
CAPTION_1_HT	Caption(1) Height
VALIDATIONPROC	ValidationProc
CAPTION_2_HT	Caption(2) Height

GTVDPRP**Step Property Validation Table**

CAPTION_3_HT	Caption(3) Height
CAPTION_3_TOP	Caption(3) Top
BOUNDCOLUMNS	Bounded Population Columns
CAPTION_2_TOP	Caption(2) Top
CAPTION	Caption
CAPTION_1	Caption(1)
CAPTION_2	Caption(2)
CAPTION_3	Caption(3)
COLUMNHEADERS	Column Headers
CAPTION_1_TOP	Caption(1) Top

GTVDSTP**Step Type Code Validation Table**

ONEWIN	One Window Step Type
TEXT	Text Step Type
OPTION	Option Step Type
COLUMNMAP	Column Mapping Step Type
TWOWIN	Two Window Step Type
WKSHEET	Open Worksheets Step Type
FREEFORMAT	Free Format Entry Step type

GTVDUNT**Duration Unit Code Validation Table**

Code	Description	Number of Days	VR Message Number
WEEK	Weeks	7	
MTHS	Months	31	

GTVEQNM**Event Code Validation Table**

ADD_REGISTRATION	Add New Registration to CP
ADD_NEW_STU_USER	Add New Student User to CP
GRADE_CHANGE	Grade Change
GRADE_ROLL	Grade Roll
APPLICATION_RECEIVED	Admissions Application Receipt
CHANGE_PIN	Change PIN in CP

GTVEQNM**Event Code Validation Table**

CHANGE_MAJOR	Change Student Major in CP
CHANGE_PERSON_ID	Change Person ID in CP
CHANGE_PERSON_NAME	Change Person Name in CP
SECTION_CANCELLED	Cancelled Section Broadcast
PAFCHANGE	Changes to the PAF on NOAEPAF
NEWGIFT	A new Gift from a donor
WITHDRAWSTUDENT	Student Withdrawal
PSWDCHANGE	Password Change
GRADECHG	A Students Grade Change
DOCAPPROVE	Documents for Approval
EDOCUMENT	Electronic Document
FAWITHDRAW	Financial Aid Withdraw Student
DROP_REGISTRATION	Drop Registration from CP
ADD_SECTION	Add New Section to CP
ADD_TEACH_ASSIGN	Add Teaching Assignment to CP
DELETE_TEACH_ASSIGN	Delete Teaching Assignment
CHANGE_SECTION_NUM	Change Section Number in CP
CHANGE_COURSE_TITLE	Change Course Title in CP
CHANGE_COURSE_DEPT	Change Course Department in CP
DELETE_SECTION	Delete Section from CP
ADD_NEW_FAC_USER	Add New Faculty User to CP
ADD_HOLD	Add Hold Smart Event
END_TERM	End Term in CP
ADD_TERM	Add New Term to CP

GTVEQNM**Event Code Validation Table**

EMAIL_UPDATE	E-Mail Address Update
EMAIL_INSERT	E-Mail Address Insert
ICASSIGN	IMS Faculty Assignment Event
ICENROLL	IMS Enrolled Student Event
ICPERSON	IMS Person Event
ICSECTION	IMS Section Event
ICTERM	IMS Term Event
CHANGE_MEETINGS	Meeting Times in CP
CHANGE_EMAIL_ID	EmailID change in CP
CHANGE_SCHEDULE_CODE	Schedule code change in CP
LDITERM	LDI Term Event
LDIPERSON	LDI Person Event
LDICOURSE	LDI Course Event
LDISECTION	LDI Section Event
LDICOLLEGE	LDI College Event
LDIDEPT	LDI Department Event
LDIXLGRP	LDI Cross Listed Group Event
LDIXLMEM	LDI Cross Listed Member Event
LDIENROLL	LDI Student Enrollment Event
LDIASSIGN	LDI Faculty Assignment Event

GTVEQPC**Group Code Validation Table**

ID-MESSAGE	ID and Message
PINCHANGE	PIN Change
CHGMAJOR	Change Student Major in CP
CHGNAME	Change Person Name in CP
CHGPERSID	Change Person ID in CP

Group Code Validation Table

ADDREG	Add New Registration to CP
ADDSECTION	Add New Section to CP
PAFCHANGE	PAF Change on NOAEPAF
NEWGIFT	A new Gift
WDSTUDENT	Withdraw a Student
PSWDCHANGE	Password Change
GRADECHG	Grade Change
DOCAPPROVE	Documents for Approval
EDOCUMENT	Electronic Document
FAWITHDRAW	Financial Aid Withdraw Student
DROPREG	Drop Registration from CP
ADDSTUDENT	Add New Student User to CP
ADDTCHASG	Add Teaching Assignment
DELTCHASG	Delete Teaching Assignment
CHGSECNUM	Change Section Number in CP
CHGTITLE	Change Course Title in CP
CHGDEPT	Change Course Department in CP
DELSECTION	Delete Section from CP
ADDFACULTY	Add New Faculty User to CP
CHGGRADE	Grade Change
GRADEROLL	Grade Roll
ENDTERM	End Term in CP
ADDTERM	Add New Term to CP
ADDHOLD	Add New Hold in CP
EMAILUPD	E-Mail Update
EMAILINS	E-Mail Insert
ICASSIGN	IMS Teaching Assignment Parm
ICENROLL	IMS Student Enrollment Parm
ICPERSON	IMS Person Parm
ICSECTION	IMS Section Parm
ICTERM	IMS Term Parm
CHANGEMEET	Class Meetings Times in CP
CHGEMAILID	Change EmailID in CP
CHGSCHCODE	Change Schedule Code
LDITERM	LDI Term Parm
LDIPERSON	LDI Person Parm
LDICOURSE	LDI Course Parm
LDISECTION	LDI Section Parm
LDICOLLEGE	LDI College Parm
LDIDEPT	LDI Department Parm

GTVEQPC**Group Code Validation Table**

LDIXLGRP	LDI Cross Listed Group Parms
LDIXLMEM	LDI Cross Listed Member Parms
LDIENROLL	LDI Student Enrollment Parms
LDIASSIGN	LDI Faculty Assignment Parms

GTVEQPM**Parameter Code Validation Table**

MESSAGE	Message
ID	Person ID
EVENTTYPE	Event Type
\$TEMPLATE	Template Name
SUBEVENTTYPE	Sub Event Type
CLEARTEXT/SCT.CREDENTIAL	Profile PIN Value
CLEARTEXT/CREDENTIAL	Campus Pipeline PIN Value
EmailID	E-Mail Address
UserName	Student/Faculty ID
Major	Student Major
LastName	Person Last Name
FirstName	Person First Name
SCT.ID	Student/Faculty ID
DONORNAME	Name of Donor
DONORPDC	Donor's Primary Donor Category
GIFTAMT	the amount of the Gift
GIFTDATE	the date of the gift
GIFTNO	a Gift number
PIDM	pidm
TERM	Term Code

GTVEQPM**Parameter Code Validation Table**

ENC_PASSWORD	Encrypted Oracle Password Code
ORACLE_USERNAME	Oracle Username Code
DOCTYPE	Document Type
ACAT_CODE	PAF Approval Category Code
EFFECTIVE_DATE	effective date
EMPLOYEE_CLASS	Employee Class
EVENTNAME	Workflow Event Name (required)
PAF_ORIGINATOR_USERID	PAF Originator Oracle Userid
POSITION	Position
PRODUCTTYPE	Workflow Product Type (reqd)
TRANS_NO	PAF Transaction Number
TRANS_STATUS	PAF Transaction Status
WORKFLOWSPECIFICNAME	Workflow Specific Name (reqd)
DOCNUMBER	Document Number
AIDY	Aid Year Code
WITHDRAW_DATE	Withdraw Date
IDType	ID Type
SCT.Term.Description	Term Description
SCT.Course.Title	Course Title
SCT.Course.Term	Course Term
SCT.Course.Section	Course Section
SCT.Course.Instructor.ID	Course Instructor ID
SCT.Course.Instructor	Course Instructor Name
SCT.Course.Department	Course Department
Role	Profile Role

GTVEQPM**Parameter Code Validation Table**

EnrolledCourse	Enrolled Course (CRN Term)
ClearText/SCT.Credential	Profile PIN Value
ClearText/Credential	Profile PIN Value
DELIVERYTYPE	Message Delivery Type for CP
DisplayName	Display Name for CP
EnrollmentStatus.FullTime	Enrollment Status Description
MiddleName	Person Middle Name
SCT.Activity.Date	Activity Date
SCT.Course.Number	Course Number
SCT.Hold.Description	Hold Type
SCT.Section.Title	Section Title
SCT.Subject.Code	Subject Code
SCT.Term.Active	Term Active
SCT.Term.End.Date	Term End Date
SCT.Term.Sort.Key	Term Sort Key
SCT.Term.Start.Date	Term Start Date
url-0.TERM	Term Code for Smart Event
DATATYPE	Gen. Identifier for Event Type
G.DESCRPTION.LONG	Long Group Name
G.DESCRPTION.SHORT	Short Group Name
G.ENROLLCONTROL.ENROLLACCEPT	Accept Enrollment- Yes/No
G.ENROLLCONTROL.ENROLLALLOWED	Allow Enrolling- Yes/No
G.EXTENSION.DELIVERY	Course content delivery
G.GROUPTYPE.TYPEVALUE	Type Value
G.GROUPTYPE.TYPEVALUE.LEVEL	Type Value Level

GTVEQPM**Parameter Code Validation Table**

G.ORG.ID	Org. Identifier
G.ORG.ORGNAM	Organization Name
G.ORG.ORGUNIT	Admin Unit, Math/English
G.RELATIONSHIP.LABEL	Nature of Group & SubGroup
G.RELATIONSHIP.MYRELATIONSHIP	1=Parent, 2=Child, 3=Other
G.RELATIONSHIP.SOURCEDID.ID	Group/SubGroup ID by System
G.SOURCEDID.ID	Group/SubGroup ID by System
G.TIMEFRAME.BEGIN	Available Participation Date
G.TIMEFRAME.END	Defines End Date
G.TRANSACTION	Rec type, 1 add/2 update/3 del
M.EXTENSION.MIDTERMRESULT.MODE	Desc of Midterm Grading Mode
M.MEMBER.IDTYPE	1=Person, 2=Group
M.MEMBER.ROLE.FINALRESULT.MODE	Desc of Final Result Mode
M.MEMBER.ROLE.ROLETYPE	01=Learner, 02=Instructor
M.MEMBER.ROLE.STATUS	1= Active, 2= Inactive
M.MEMBER.ROLE.SUBROLE	Further Defines Roles
M.MEMBER.ROLE.TRANSACTION	Rec type, 1 add/2 update/3 Del
M.MEMBER.ROLE.USERID	Person's ID to Access Group
M.MEMBER.SOURCEDID.ID	ID of Org. or Source
M.SOURCEDID.ID	Person/Group/Sub Unique ID
P.ADR.COUNTRY	Country
P.ADR.LOCALITY	Locality/City
P.ADR.PCODE	Postal Code
P.ADR.REGION	State or Province
P.ADR.STREET	Street Address

GTVEQPM**Parameter Code Validation Table**

P.DEMOGRAPHICS.GENDER	Gender of Person
P.EMAIL	Email Address of Person
P.EXTENSION.USERROLE	User Role
P.EXTENSION.WEBCREDENTIAL	Web Credential
P.NAME.FN	Person's name
P.NAME.N.FAMILY	Family name not last name
P.NAME.N.GIVEN	Given name
P.NAME.N.OTHER	Other name parts
P.NAME.N.PREFIX	Mr, Mrs, Ms, Dr etc
P.NAME.N.SUFFIX	Jr, III, Sr
P.NAME.NICKNAME	Perferred Name and format
P.SOURCEDID.ID	Person ID defined by Source
P.TEL	Phone Number of Person
P.TEL.TELTYPE	Phone# type, 1=Voice or 2=Fax
P.TRANSACTION	Rec type, 1 add/2 update/3 del
P.USERID	Person's access ID
SCT.Course.Delivery	Course content delivery
SCT.Course.ClassTimes	Class Meeting Times
SOURCE	Source of Event
M.EXTENSION.GRADABLE	Gradable Indicator
M.MEMBER.ROLE.COMMENTS	Member Comments
G.GROUPTYPE.SCHEME	Group type Coding Scheme
G.TIMEFRAME.BEGIN.RESTRICT	Allow Participation?- Yes/No
G.TIMEFRAME.END.RESTRICT	Defines Participation Ending
ClearText.Credential	Campus Pipeline Password Value

GTVEQPM**Parameter Code Validation Table**

ClearText.SCT.Credential	Profile PIN Value
SourcedID.Source	Identifier for Source System
SourcedID.ID	Unique ID defined by Source
G.EXTENSION.DEL.RELATIONSHIP.LABEL	Nature of Group and SubGroup
G.EXTENSION.DEL.RELATIONSHIP.MYRELATIONSHIP	1=Parent, 2=Child, 3=Other
G.EXTENSION.DEL.RELATIONSHIP.SOURCEDID.ID	Group/SubGroup ID by System
G.ATT.RECSTATUS	IMS Record Status
G.DESCRPTION.FULL	Full Group Description Name
G.EXTENSION.LUMINISGROUP.DELIVERYSYSTEM	System delivering content
G.EXTENSION.LUMINISGROUP.EVENTS.RECURRINGEVENT.BEGINDATE	Event Begin Date
G.EXTENSION.LUMINISGROUP.EVENTS.RECURRINGEVENT.BEGINTIME	Event Begin Time
G.EXTENSION.LUMINISGROUP.EVENTS.RECURRINGEVENT.DAYSOFWEEK	Event Days of the Week
G.EXTENSION.LUMINISGROUP.EVENTS.RECURRINGEVENT.ENDDATE	Event End Date
G.EXTENSION.LUMINISGROUP.EVENTS.RECURRINGEVENT.ENDTIME	Event End Time
G.EXTENSION.LUMINISGROUP.EVENTS.RECURRINGEVENT.EVENTDESC	Event Description
G.EXTENSION.LUMINISGROUP.EVENTS.RECURRINGEVENT.LOCATION	TBA or Bldg w/ Room Number
G.EXTENSION.LUMINISGROUP.SORT	Term Sort Order
G.GROUPTYPE.TYPEVALUE.ATT.LEVEL	Group Type Level 1
G.RELATIONSHIP.ATT.RELATION	Group Relationship Attribute
G.TIMEFRAME.BEGIN.ATT.RESTRICT	Begin Restriction Attribute
G.TIMEFRAME.END.ATT.RESTRICT	End Restriction Attribute

GTVEQPM**Parameter Code Validation Table**

M.MEMBER.ROLE.ATT.RECSTATUS	IMS Record Status
M.MEMBER.ROLE.ATT.ROLETYPE	Membership roletype
M.MEMBER.ROLE.EXTENSION. LUMINISROLE.GRADABLE	Gradable Indicator
M.MEMBER.ROLE.INTERIMRESULT.ATT. RESULTTYPE	Midterm result attribute
M.MEMBER.ROLE.INTERIMRESULT.MODE	Desc of Midterm Grading Mode
ONLINETOPIC	Y = publish to LMS
P.ATT.RECSTATUS	IMS Record Status
P.EXTENSION.LUMINISPERSON. ACADEMICDEGREE	Faculty Academic Degree
P.EXTENSION.LUMINISPERSON. ACADEMICMAJOR	Student Academic Major
P.EXTENSION.LUMINISPERSON. ACADEMICTITLE	Faculty Academic Title
P.EXTENSION.LUMINISPERSON. CUSTOMROLE	Custom Person Role
P.INSTITUTIONROLE.ATT. INSTITUTIONROLETYPE	Person Institution Role
P.INSTITUTIONROLE.ATT. PRIMARYROLE	Person Primary Role
P.NAME.N.PARTNAME	Middle Name
P.NAME.N.PARTNAME.ATT. PARTNAMETYPE	Partname Type (Middlename)
P.TEL.ATT.TELTYPE	Telephone type attribute
P.USERID.ATT.PASSWORD	Userid password attribute
P.USERID.ATT.USERIDTYPE	Userid type attribute

GTVEQTS**Target System Code Validation Table**

PIPELINE

Campus Pipeline

GTVEQTS**Target System Code Validation Table**

WORKFLOW	SCT Workflow
INTCOMP	SCT Integrator
LDI	Luminis Data Integration

GTVLETR**Letter Process Letter Validation Table**

Code	Duplicate	Description	Print Command	AlternateLetter Code
MG_ACKN_LTR	Y	Matching Gift Acknowledgement		
EMP_MG_NOTICE	Y	Employee Notification of Match		
GIFT_RECEIPT	Y	Gift/Pledge Payment Receipt		
GIFT_ACKN_LTR	Y	Gift Acknowledgement Letter		
PLEDGE_ACKN	Y	Pledge Acknowledgement Letter		
DIRECTOR_THANKS	N	Director's Gift Thank you Ltr		
PLEDGE_REMINDER	Y	Special Pledge Reminder Letter		
SPECIAL_GIFT	N	Special Gift Acknowledgement		
MAILING_LABEL	N	Mailing Label	PL	
DCSN	N	Decision letters		
MAJOR_GIFT	N	Major Gift Acknowledgement		
CORP_GIFT_ACKN	Y	Corporate Gift Acknowledgement		
FOUNDATION_ACKN	Y	Foundation Gift Ackn Letter		

GTVLETR**Letter Process Letter Validation Table**

Code	Duplicate	Description	Print Command	AlternateLetter Code
FOUN_PLDG_ACKN	Y	Foundation Pledge Ackn Letter		
ANNUAL_FND_ACKN	Y	Annual Fund Gift Ackn Letter		
RECEIPT	Y	Gift Receipt		
FA_AWRD_W_COST	Y	FA Award Letter with Costs		
RESEARCH_PROFIL	Y	Prospect Research Profile		
WKBOOKLTR	Y	Sample letter for G01C		
ADM_APPL_ACKN	N	Admissions Application Ackn		
INQUIRY_THANKS	Y	Thank you ltr all inq types		
INF_REQ	Y	Information Request Letter		
DUES_ACKNOW	Y	Dues Acknowledgement		A/D_ACK_SPECIAL
MEMBER_CARD	Y	Membership Card		
MEMB_DUES_ACK	Y	Sample Membership Dues Letter		
MEMBER_REMINDER	Y	Membership Reminder Letter		
MEMBER_RENEWAL	Y	Membership Renewal Letter		
MEMBER_RENEW_3	Y	Membership 3rd Party Renewal		
INVITATION	Y	Invitation Letter		
FA_TRACKING	Y	Missing Inform. Letter - FINAID		
AD_ACK_SPECIAL	N	Acknowledgement of Special Gif		AD_ACK_TWO

GTVLETR**Letter Process Letter Validation Table**

Code	Duplicate	Description	Print Command	AlternateLetter Code
AD_ACK_TWO	Y	Second Special Ackn of Gifts		
AD_ACK_GIFTS	Y	Gift Acknowledgement Letter		
AD_QUIK_RECPT	Y	Quick On line Gift Receipt		
ADM_CHKL	N	Admissions Checklist Letter		
ADM_INT_1	N	Admissions Interview 1 Letter		
ADM_FA_INTEREST	N	Financial Aid Interest Letter		
T	Y	t		
TEST	Y	t		
HOUSING	Y	Housing Information Letter		
STEW_STUDENT	Y	Stewardship Letter to Student		
STEW_DESG_ID	Y	Letter to Designation ID		
COB_PCRNOTF_18M	Y	Cobra 18 Month Notification		
COB_PCRNOTF_36M	Y	Cobra 36 Month Notification		
COB_PCRLTRS_ENR	Y	Cobra Enrollment End Notices		
COB_PCRLTRS_LAT	Y	Cobra Late Notices		
COB_PCRLTRS_TER	Y	Cobra Termination Notices		
COB_PCRLTRS_PEX	Y	Cobra Pre-Expiration Notices		

GTVLFST	Learner Field of Study Type Validation Table	
	MAJOR	Major
	MINOR	Minor
	CONCENTRATION	Concentration

GTVMTYP	Meeting Type Validation Form	
	CLAS	Classroom

GTVOBJT	VBS Object Code Validation Table	
	FORM	Oracle Forms module
	JOBS	Job Submission object
	MENU	Menu object
	MESSAGE	Menu Message object
	QUICKFLOW	QuickFlow object
	DLL	Dynamically Linked Library

GTVPARA Letter Process Paragraph Validation Table

Code	Description	Comment
STU_SAL	Student Salutation	Student Name, Addr, ID followed by 'Dear xx,'
LABELDT	Define tables for Labels	Header paragraph containing define tables and invokes table 1.
LABELS	Finaid label body	Body for labels
AWARD	Body of Finaid Award Letter	contains everything
APPADDR	Student's Name and Address	From the Student's Current Financial Aid Application
FA_NP	New page of letter	Start each letter at new page
AWARDS	Award Letter - Award Amounts	Award letter amount per term.
AWRDCLS	Award Letter Closing	Award letter closing with Sincerely, name and title of financial aid officer.
AWRDCST	Award Letter - Costs	Award letter costs, contributions, outside resources (with totals) and need

GTVPARA**Letter Process Paragraph Validation Table**

Code	Description	Comment
AWRDFAT	Award Letter - FAT Requirement	Financial Aid Transcript Requirements for Award Letter
AWRDHDR	Award Letter Heading	Award Letter Heading
AWRDINT	Award Letter Introduction	Award letter introduction with aid year desc
AWRDREQ	Award Letter - Requirements	Award letter requirements
AWRD_DT	Table Definitions for Award	Table Definitions for Financial Aid Award Letter
AWRD_NP	New Page for Award Letter	New Page with #RR for Award Letter
AWRD_TE	Table End for Award Letter	Table End for Financial Aid Award Letter
BASIC	basic constituent info	
GURADDR	Person Name/Address	Prints the person's name and address on the right margin.
GURINST	Institution Name/Address	Prints the institution address on the right margin of the page.
SRRCLOS	Recruiting Closing	Prints the titles of the person defined by the initial code.
SRRPRES	Presidential Greeting	Paragraph with presidential greeting message.
SRRINT1	Interview One Follow-up	Paragraph with Interview One Message.
SRRINT2	Interview Two Follow-up	Paragraph with Interview Two Message.
SRRCNN1	College Night Follow-up	Paragraph with College Night Message.
GURCLOS	Closing	Prints "Sincerely" and spacing on the bottom of the page.
GURLABL	Mailing Label Name/Address	Paragraph with name and address to be used as mailing label.
CALCVAR	Calculated Variables	Calculated Variables in Financial Aid Award Letter
FADIR	Financial Aid Director	Financial Aid Director's Name

GTVPARA**Letter Process Paragraph Validation Table**

Code	Description	Comment
FA_HEDR	Financial Aid Letter Header	Header for Financial Aid Tracking Letter
FA_SALU	Financial Aid Salutation	Financial Aid Salutation Paragraph
FUNDMSG	Message Text for Funds	Message text associated with selected fund codes.
GURSALU	Salutation	Prints the date on right margin and “Dear xx” on the left margin.
INAME	Name, address of Institution	Institution Name and Address printed in the center of the letter, 1 line per address field except city/state/zip
TABLE1	Invoke Table 1	Invoke Table 1 in Financial Aid Award Letter
TRACK12	Tracking Paragraph w. Msgs	Tracking Paragraph using messages from RORMESG table
LABEL	File Labels	Internal File labels
MLABEL	Mailing Label - Name / Address	Paragraph with name and address to be used as a mailing label
AK_RCPT	A/D Gift Ack. Receipt	Alumni/Development gift acknowledgement receipt.
TRACK	Financial Aid Req. Tracking	Body of Financial Aid Requirements Tracking Letter
TRCK_DT	Table Definitions for Tracking	Table Definitions for Financial Aid Tracking Letter
RESEARC	info from prospect research	
ACK_TAB	Ack tables 1-3	Gift Acknowledgement letter table definition.
AKGBODY	Alumni/Dev ack gift body	Gift acknowledgement thank you with amount, campaigns.
ANAMEAD	Alumni Ack Const. addr name	Acknowledgemnt address name for constituent.
ANAMESL	A/D Ack. first name salutation	Alumni Development name salutation for acknowledgements.

GTVPARA**Letter Process Paragraph Validation Table**

Code	Description	Comment
AORGNNM	Alumni Ack org addr name	Acknowledgement address name for organization.
AORGNSL	A/D Ack. orgn. name salutation	Alumni Development org primary name salutation for acknowledgements.
APREFAD	Alumni Ack preferred address	Preferred address type from constituent form.
AKGCLAS	Alumni/Dev ack Class paragraph	Gift acknowledgement preferred class reference.
A_ETAB	End table	
A_ITAB1	Invoke table 1	Alumni Invoke table 1.
SIGN	Signature block	Prints Sincerely, name, and title for initials used with letter
AKGSIGN	Alumni/Dev ack signature	Gift acknowledgement signature
AK_RAMT	A/D Gift Ack. Receipt amount	Alumni/Development gift acknowledgement receipt amt, date, gift number.
LTRDATE	Letter Date	
TOPPAGE	Top of Page	
ACPT_TE	Ends tables for Acceptance	End table commands for acceptance letters
CHKLLST	List of Checklist items	Lists each checklist items and it received date after body of letter
INFADDR	Informal name, address, & salut	Prints the name, street, city, state, zip and salutation without a title (i.e. Mr., Dr.)
INQUIRY	Body of the Inquiry thanks ltr	Prints the body & closing of the Inquiry_thanks letter with use of most recruiting variables
ADMACKL	Admissions Application Ackl	Admissions Application Acknowledgement, including missing Checklist Items, if any
FRMADDR	Formal Name, Address & Sal	Prints the formal name with prefix and suffix, full address and salutation

GTVPARA**Letter Process Paragraph Validation Table**

Code	Description	Comment
INADDRS	Institution Name & address	Prints and centers the institution name, address, & phone #
ACCEPT	Admissions Acceptance Para	Body of the Admissions Acceptance letter
TB_RECR	Table for Recruiting Letter	Table to Indent Institution Name and Signature Variable
CLOSING	Admissions/Recruiting Closing	Prints Sincerely, name, and title for initials
INFOREQ	Information Request	Body of information request letter
GURPERS	Person Name/Address	Prints the persons name and address on the left margin of the page.
WKBOOK1	Workbook Para 1 (Inside Addr)	This is the first paragraph used in the Letter Generation Textbook. Notice that this long comment scrolls. The paragraph includes today's date, name and address. It includes examples of the use of the ^IFNULL command.
ACPT_DT	Table definitions for Accept	All table definitions used for Acceptance
OPENHOU	Body of the Open House Letter	Prints the body of the Open House Invitation Letter
HEADER	Use as 1st Paragraph	Forces new page. Prevents page creep.
CLOSE	Sharon Weinberg Signature	Includes skip after body, closing and signature
APPOINT	Recruiting Appointment Letter	Includes appointment type, date and times.
DUE_ACK	Dues Acknowledgment Body	
DUE_TAB	Dues Acknowledgment Tables	
MEMB_CD	Membership Card Paragraph	
MEMB_TB	Membership Define Tables	
MEM_3TB	Renewal Letter -3rd Party Tabl	Tables for 3rd Party Renewal Letter
CHKLBDY	Admissions Checklist	Body of Admissions Checklist letter
MEM_REM	Reminder Letter Paragraph	

GTVPARA**Letter Process Paragraph Validation Table**

Code	Description	Comment
MEM_REN	Renewal Letter Paragraph	
MEM_RN3	Renewal Letter - 3rd Party	
ACK_TDF	Table Definitions for Gift Ack	Gift Acknowledgement letter table definition.
ACK_NPG	New Page Command	
ACK_LIN	Line Count for Page	
ACK_DTE	Letter Date	
ACK_NAD	Name and Address for Ack.	Person or Org Name and Address
ACK_SAL	Person/Org Salutations	Person or organization salutations for acknowledgement/receipt
ACK_BDY	Body of Acknowledgement Letter	
INVITE	Invitation for a Function	
HEADDTE	Letter Date	Prints current date on left side of page
NEWPAGE	New page for letter	Start each letter at new page
WKBOOK2	Workbook Para 2 (Inf Sal)	Workbook paragraph 2, which contains an informal salutation followed by a comma.
WKBOOK3	Workbook Para 3 (Person Verf)	Workbook paragraph 3, which contains the body of the letter (current Id, gender and marital status).
ENCL	Enclosures Paragraph	
T	t	
MNYROOM	More than 1 Roommate Info	Paragraph to Print Address/Phone Info for More than 1 Roommate
MANYALT	Many Roommates Alternate Para	Alternate Paragraph Formatting for Printing Many Roommates Info
ONERALT	One Roommate Alternate Para	Alternate Paragraph Formatting for Printing One Roommate Info

GTVPARA**Letter Process Paragraph Validation Table**

Code	Description	Comment
CLSHOUS	Closing for Housing Letter	Closing for Housing Letter
SNGLERM	Single Room Housing Info	Paragraph to Print Single Room Housing Information
ONEROOM	One Roommate Housing Info	Paragraph to Print Address/Phone Info for One Roommate Only
INTHOUS	Introduction to Housing Letter	Introduction to Housing Letter
TB_HOUS	Table for Housing Letter	Table Definitions for Housing Letter
STEW2	Stewardship to student	Stewardship letter to student
STEW1	Stewardship to Desg ID	Stewardship letter to designation ID
COB_TAB	Cobra Tables	
COB_NPG	Cobra New Page	
COB_HDR	Cobra Header	
COB_NTA	Cobra Notification Letr Para 1	
COB_NTB	Cobra Notification Letr Para 2	
COB_NTC	Cobra Notification Letr Para 3	
COB_NTD	Cobra Notification Letr Para 4	
COB_NTE	Cobra Notification Letr Para 5	
COB_NTF	Cobra Notification Letr Para 6	
COB_SSD	Cobra SS Procedure	
COB_SSP	Cobra SS Procedure	
COB_ELE	Cobra Election form	
COB_ENR	Cobra Enrollment End Notices	
COB_LAT	Cobra Late Notices	

GTVPARA**Letter Process Paragraph Validation Table**

Code	Description	Comment
COB_TER	Cobra Termination Notices	
COB_PEX	Cobra Pre-Expiration Notices	
COB_HLP	Cobra Admin Contact Address	

GTVPARS**Partition Code Validation Table**

Code	Description	Scheduler Number	Campus Code
0	Default Partition	0	

GTVPROC**Process Name Validation Table**

WEBCCEPRTREQ	Web Credit Card Enrollment Verification Charge Process
WEBCCREGFEEES	Web Credit Card Registration Fees Process
WEBCCAPPFEEES	Web Credit Card Application Fees Process
WEBCCGRADAPP	Web Credit Card Graduation Application Process

GTVRRAC**Regulatory Race Validation Table**

1	American Indian or Alaskan Native
2	Asian
3	Black or African American
4	Native Hawaiian and Other Pacific Islander
5	White

For all entries above, **Data Origin** is null.

Scheduling Status Code Validation Form

NSM	Class needs a room assignment.
1SM	Class needs a room assignment and has a preferred first choice room indicated in the Room Name field. This code limits the initial pool of candidate rooms in the assignment algorithm.
WSM	Class needs a room assignment and must be assigned with the preceding NSM or 1SM record to the same room at the same time (cross-listed).
RSM	Class is related to the preceding NSM or 1SM record and must be assigned to the same room but not at the same days/time.
NXM	Class needs a room assignment and can share a room with another class whose times overlap with it (can be double-booked).
1XM	Class needs a room assignment, has a preferred first choice room indicated in the Room Name field, and can share a room with another class whose times overlap with it (can be double-booked).
RXM	Class is related to the previous NXM or 1XM record and must be assigned to the same room at the same or overlapping times.
ASM	Class has a room assignment that was made manually or in another system, such as the student information system.
AXM	Class has a room assignment that was made manually or in another system, and the class time span overlaps part of all of the time span of another class assigned to the same room (double-booking or intentional conflict).
HSM	This is a set of home cross-listed classes pre-assigned to the same room at identical days and times.
VSM	This is a set of visitor cross-listed classes pre-assigned to the same room at identical days and times.
5SM	Schedule25 assigned the class a room during a previous run.
5XM	Schedule25 assigned the class a room, and it is double-booked with another class.

GTVSQPR**SQL Process Code Validation Table**

Code	Description	Start Date	End Date
CARDHOLDER_ROLES	Cardholder roles	19-Oct-05	
HOUSING_ELIGIBILITY	Housing Integration, Eligibility Roles	19-Oct-05	
INTCOMP	Integration roles	27-Oct-05	
SEVIS	SEVIS Processing	2-Oct-03	

GTVSQRU**SQL Rule Code Validation Table**

Code	Description	Start Date	End Date
ALUMNUS	Alumnus Role	19-Oct-05	
EMPLOYEE	Employee Role	19-Oct-05	
STUDENT	Student Role	19-Oct-05	
STUDENT_ENROLLED	Student with enrollment in given term	19-Oct-05	
ALUMNI	Alumni Role	27-Oct-05	
FACULTY	Faculty Role	27-Oct-05	
FRIENDS	Friend Role	27-Oct-05	
FINANCE	Finance Role	27-Oct-05	
DEVELOPMENTOFFICER	Development Officer Role	27-Oct-05	
PROSPECT	Prospect Role	27-Oct-05	
APPLICANT	Applicant Role	27-Oct-05	
INTACCEPT	Institution Accept Role	27-Oct-05	
APPACCEPT	Applicant Accept Role	27-Oct-05	
IAM_GOBEACC_RULE	GOBEACC attributes for IAM		

GTVSVAP**SEVIS Auto-populate Code Validation Table**

GOBSEVS_VTYP_CODE	Visa type code
GOBSEVS_BIRTH_NATN_CODE	Birth nation code
GOBSEVS_LEGAL_NATN_CODE	Legal nation code
GOBSEVS_PROGRAM_BEGIN_DATE	Program begin date
GOBSEVS_PROGRAM_END_DATE	Program end date
GOBSEVS_PROGRAM_ENROLL_DATE	Program enroll date
GOBSEVS_ACADEMIC_TERM_MONTHS	Academic term in months
GOBSEVS_TUITION_EXPENSE	Tuition expense
GOBSEVS_PERSONAL_FUNDS	Personal funds
GOBSEVS_SESSION_START_DATE	Session start date
GOBSEVS_SESSION_END_DATE	Session end date
GOBSEVS_SVEL_CODE	Education level code

GTVSVAP SEVIS Auto-populate Code Validation Table

GOBSEVS_SVEL_COMMENT	Education level comment
GOBSEVS_MAJR_CODE	Major code
GOBSEVS_STUDY_LENGTH	Length of study in months
GOBSEVS_LIVING_EXPENSES	Living expenses
GOBSEVS_SVFT_CODE	Drop below full-time status code
GOBSEVS_AUTH_START_DATE	Authorized start date
GOBSEVS_COMPLETION_REMARKS	Completion remarks
GOBSEVS_NEW_PROGRAM_END_DATE	New program end date
GOBSEVS_DA_PROGRAM_END_DATE	Deferred attendance program end date
GOBSEVS_DA_PROGRAM_START_DATE	Deferred attendance program start date
GOBSEVS_DISC_ACTION_TEXT	Disciplinary action comment
GOBSEVS_EXTEND_END_DATE	Extension end date
GOBSEVS_SVCR_CODE	Creation reason code
GOBSEVS_SVCR_COMMENT	Creation reason comment
GOBSEVS_SVTR_CODE	Termination code
GOBSEVS_TERMINATE_DATE	Termination date
GOBSEVS_OTHER_INFRACT_COMMENT	Infraction comment
GOBSEVS_SVEP_CODE	End program code
GOBSEVS_END_PROGRAM_EFF_DATE	End program effective date
GOBSEVS_EV_FORM_NUMBER	Exchange Visitor form number
GOBSEVS_SVRP_CODE	Reprint reason code
GOBSEVS_REPRINT_REASON_COMMENT	Reprint reason comment
GOBSEVS_PRINT_REQUEST_IND	Print request indicator
GOBSEVS_DEPENDENT_EXPENSES	Dependent expenses
GOBSEVS_OTHER_FUNDS	Other funds
GOBSEVS_OTHER_FUNDS_COMMENT	Other funds comment
GOBSEVS_OTHER_EXPENSES	Other expenses
GOBSEVS_OTHER_EXP_COMMENT	Other expenses comment
GOBSEVS_AUTH_END_DATE	Authorization end date
GOBSEVS_NEW_PROGRAM_START_DATE	Program initial start date for continuing EV
GOBSEVS_SVPC_CODE	Program code
GOBSEVS_SVSC_CODE	Subject code
GOBSEVS_SVSC_COMMENT	Subject code comment
GOBSEVS_COMMUTER_IND	Commuter indicator
GOBSEVS_ENG_PROF_REQ_IND	English proficiency required indicator
GOBSEVS_ENG_PROF_MET_IND	English proficiency met indicator
GOBSEVS_ENG_PROF_REASON	English proficiency comment

GTVSVAP SEVIS Auto-populate Code Validation Table

GOBSEVS_CRIMINAL_CONVICT_IND	Criminal conviction indicator
GOBSEVS_ADMISSION_NUMBER	Admission number
GOBSEVS_DRIVERS_LIC_NUMBER	DriverNULLs license number
GOBSEVS_STAT_CODE_DRIVERS_LIC	DriverNULLs license state of issue
GOBSEVS_TIN	Taxpayer identification number
GOBSEVS_MAJR_CODE_2	Secondary major code
GOBSEVS_MAJR_CODE_MINR	Minor code
GOBSEVS_SCHOOL_FUNDS	School funds
GOBSEVS_SCHOOL_FUNDS_COMMENT	School funds comment
GOBSEVS_EMPLOYMENT_FUNDS	Employment funds
GOBSEVS_FUNDING_COMMENT	Funding comment
GOBSEVS_SVFT_COMMENT	Drop below fill time status comment
GOBSEVS_SVEP_COMMENT	End program comment
GOBSEVS_DA_COMMENT	Deferred attendance comment
GOBSEVS_PASSPORT_NUMBER	Passport number
GOBSEVS_NATN_CODE_PASSPORT	Country issuing passport
GOBSEVS_PASSPORT_EXPIRE_DATE	Passport expiry
GOBSEVS_VISA_NUMBER	Visa number
GOBSEVS_SVCP_CODE	Consular post code
GOBSEVS_VISA_EXPIRE_DATE	Visa expiry
GOBSEVS_PENT_CODE	Port of entry code
GOBSEVS_PENT_COMMENT	Port of entry comment
GOBSEVS_ENTRY_DATE	Entry date
GOBSEVS_RFC_COMMENT	Resume full course comment
GOBSEVS_EDIT_PROGRAM_COMMENT	Edit program comment
GOBSEVS_PROGRAM_SPONSOR_FUNDS	Program sponsor funds
GOBSEVS_GOVT_ORG_FUNDS	Government organization 1 funds
GOBSEVS_SVGO_CODE	Government organization 1 code
GOBSEVS_GOVT_ORG_FUNDS_2	Government organization 2 funds
GOBSEVS_SVGO_CODE_2	Government organization 2 code
GOBSEVS_INTL_ORG_FUNDS	International organization 1 funds
GOBSEVS_SVIO_CODE	International organization 1 code
GOBSEVS_INTL_ORG_FUNDS_2	International organization 2 funds
GOBSEVS_SVIO_CODE_2	International organization 2 code
GOBSEVS_EV_GOVT_FUNDS	Funds from the EV's government
GOBSEVS_BINATION_FUNDS	Binational funds
GOBSEVS_OTHER_ORG_FUNDS	Other organization funds
GOBSEVS_PROGRAM_START_IND	Program start indicator
GOBSEVS_EXTEND_PROGRAM_COMMENT	Comment on program extension

GTVSVAP SEVIS Auto-populate Code Validation Table

GOBSEVS_AMEND_PROGRAM_COMMENT	Comment on program amendment
GOBSEVS_MATRICULATION_CDE	Matriculation code
GOBSEVS_BIRTH_CITY	Birth city
GOBSEVS_EDIT_BIO_COMMENT	Edit biographical data comment
GOBSEVS_NATN_CODE_PERM_RES	Country of permanent residency
GOBSEVS_FIN_SUPPORT_COMMENT	Financial support comment
GOBSEVS_SVIT_CODE	Infraction type code
GOBSEVS_SVCC_CODE	Category code

For all entries above, **Start Date** is *2-Oct-03* and **End Date** is null.

GTVSVBA SEVIS Business Action Code Validation Table

Code	Description	Procedure Name	Start Date	End Date
CREATE_STUDENT	Create student for SEVIS processing	goksvsq.p_create_student	2-Oct-03	
CREATE_EV	Create Exchange Visitor for SEVIS processing	goksvsq.p_create_ev	2-Oct-03	

GTVSVCC SEVIS Exchange Visitor Program Category Code Validation Table

1A	Student Secondary
1B	Student Associate
1C	Student Bachelors
1D	Student Masters
1E	Student Doctorate
1F	Student Non-degree
2A	Trainee (specialty)
2B	Trainee (non-specialty)
3	Teacher
4	Professor
5	International Visitor
6	Alien Physician
7	Government Visitor
8	Research Scholar
9	Short-term scholar
10	Specialist

GTVSVCC**SEVIS Exchange Visitor Program Category Code Validation Table**

11	Camp Counselor
12	Summer work/travel
13	Aupair

GTVSVCR**SEVIS Creation Reason Code Validation Table**

Code	Description	Usage Indicator
S	Change of Status	1
I	Initial	1
C	INAC 5/05 Continued Attendance	1
T	INAC 5/05 Transfer	1
D	INAC 5/05 Dependent	1
R	INAC 5/05 Reinstatement	1
O	INAC 5/05 Other	1
1	INACT 1/03--Begin New Program	2
2	INACT 1/03--Continuing EV	2
3	INACT 1/03Transffrom non-SEVIS	2
4	INACT 1/03--Reinstatement	2
CONT	INAC 5/05 Continuing	2
NEW	New	2

GTVSVDT**SEVIS Dependent Termination Code Validation Table**

1	Conviction of a Crime
2	Death
3	Child Over 21
4	Divorce
5	Unauthorized Employment
6	Principal Status Terminated
7	INAC 5/5 271 Days Post ProgEnd
8	INAC 5/5 271 Days Post PrinEnd
9	Other
10	Principal Status Completed
11	INAC 5/5 Terminated J-1 Visa
12	INAC 5/5 Completed J-1 Visa

GTVSVEL**SEVIS Educational Level Code Validation Table**

1	Primary
2	Secondary
3	Associate
4	Bachelors
5	Masters
6	Doctorate
7	Language Training
8	High School
9	Flight School
10	Other Vocational School
11	Other

GTVSVEP**SEVIS End EV Program Reason Code Validation Table**

COMP	Completed
1	INACT 1/03 Withdrawal From Prog
2	INACT 1/03 Can't Cont Prog
3	INACT 1/03 Death
4	INACT 1/03 Prog Comp Pre End Dt
WFP	Withdrawal from Program
ICP	Inability to Continue Program
DOE	Death of EV
PCP	Prog Complete Before End Date
NOS	INAC 5/05 No Show
CCHG	INAC 5/05 Cancel-Chg of Status
CHG	INAC 5/05 Change of Status
DCHG	INAC 5/05 Denied-Chg of Status

GTVSVFT**SEVIS Drop Below Full Time Reason Code Validation Table**

1	Illness/Medical Condition
2	Difficulty with English
3	Difficulty with Reading
4	Not Familiar with U.S. Teaching
5	Improper Level Placement
6	Will Complete within Term
7	Part-Time Commuter Student

GTVSVGO**SEVIS Governmental Organization Code Validation Table**

DOJ	Dept of Justice
ACT	Action
AID	Agency For Intl Development
BBG	Broadcasting Board of Governor
DOC	Dept of Commerce
DOD	Dept of Defense
DOE	Dept of Energy
DOED	Dept of Education
DOI	Dept of Interior
DOL	Dept of Labor
DOS	Dept of State
DOT	Dept of Transportation
EPA	Environmental Protection Ag
EXIM	Export-Import Bank
GAO	General Accounting Agency
HHS	Health and Human Services
HMC	Holocaust Memorial Council
HUD	Housing and Urban Development
LOC	Library of Congress
NASA	NASA
NDH	Nat Endowment for Humanities
NEA	Nat Endowment for the Arts
NSF	Nat Science Foundation
OTHER	Other
SI	Smithsonian Institution
TREAS	Dept of Treasury
USDA	Dept of Agriculture
USIP	US Institute of Peace
VA	Dept of Veterans Affairs

GTVSVIO**SEVIS International Organization Code Validation Table**

ECLA	UN Econ Comm. Latin Am/Carrib
ECE	UN Economic Commission Europe
ECA	UN Economic Commission Africa
ECLAC	INAC 5/05 Eco Com Latin Am/Car
ECOSOC	UN Economic and Social Council
EEC	European Economic Community
ESCAP	UN Econ Comm Asia/Far East

GTVSVIO**SEVIS International Organization Code Validation Table**

FAO	UN Food/Agriculture Org
IAEA	Intl Atomic Energy Agency
ICAO	Intl Civil Aviation Org
ILO	Intl Labor Organization
IMF	Intl Monetary Fund
IMO	Intl Maritime Organization
ITU	Intl Telecomm Union
NATO	North Atlantic Treaty Org
OAS	Org of American States
OAU	Org of African Unity
OECD	Org of Econ Coop. and Develop.
OTHER	Other
PAHO	Pan Amer Health Org
UN	United Nations
UNCTAD	UN Conf of Trade and Develop
UNDP	UN Development Program
UNESCO	UN Ed, Scient and Culture Org
UNICEF	UN Children's Fund
UNIDO	UN Industrial Devel Org
WB	World Bank
WHO	World Health Organization
WMO	World Meteorological Org

GTVSVIT**SEVIS Infraction Type Code Validation Table**

EXT	Failure to extend DS-2019 in timely manner.
CON	INAC 5/05 Failure to conclude transfer of program.
REC	Failure to receive RO/ARO approval before accepting payment
OTH	Other

GTVSVPC**SEVIS Position Code Validation Table**

110	Central Government Group
111	Head of Government
112	Ministerial Level Official
113	Executive Level Official
114	Civil Service Employee
115	Professionals and Scientists
116	Legislator/Central Government

SEVIS Position Code Validation Table

117	Judges/Central Government
118	Manager/State Enterprise
119	Central Government Other
120	State, Reg,Prov Govt Group
121	Governor/Chief of Region
122	Senior Head of Reg Dept
123	Exec Level Reg Official
124	Civil Service/Regional Govt
125	Prof and Scientist/Regional
126	Regional Legislator
127	Regional Judge
128	Regional Manager
129	Regional Govt Other
130	City/Town Government Group
131	Mayor/City Manager
132	Head of City Dept
133	Executive Level City Official
134	Civil Service/City Govt
135	Prof and Scientist/City
136	City Legislator
137	City Judge
138	Manager,City Enterprise
139	City Government Other
140	International Organization
141	Head of International Org
142	Senior Official Intl Org
143	Intl Org Employee
210	University Level Group
211	University President
212	University Admin Staff
213	Teaching Staff/University
214	University Graduate Students
215	Undergraduate Students/Univ
216	Medical School Students
217	Other Professional Students
218	Post Graduate Medical Trainee
219	University, Other
220	Secondary School Group
221	Secondary School Principal
222	Secondary School Teacher

SEVIS Position Code Validation Table

223	Secondary School Student
229	Secondary School, Other
230	Elementary School Group
231	Elementary Principal/Teacher
239	Elementary School, Other
240	Special School Group
241	Special School Head
242	Special School Teacher
249	Special School, Other
310	Private Business Group
311	Private Business Entrepreneur
312	Corporate Executive
313	Manager/Private Business
314	Employee/Private Business
315	Professional/Scientist, Bus.
319	Private Business, Other
320	Self-Employed Group
321	Self-Employed (Legal)
322	Self-Employed (Medical)
323	Self-Employed (Tech)
329	Self-Employed (Other)
330	Independent Organization Group
331	Dir Instit/Corp/Hospital
332	Mgr-Exec Empl by Instit/Corp
334	Employee Independent Inst/Corp
335	Prof/Scientist Instit/Corp
339	Inependent Org, Other
340	Agriculture Group
342	Agricultural Executive
341	Agricultural Entrepreneur
343	Agricultural Manager
344	Agricultural Employee
345	Agriculture Prof/Scientist
349	Agriculture, Other
350	Religion Group
351	Minister of Religion
352	Religious Order Member
353	Theologian
410	Arts Group
411	Artist (Graphic Arts)

SEVIS Position Code Validation Table

412	Author (Playwright,Poet)
413	Stage/Film Actor
414	Film/Stage Producer
415	Composer/Musician
419	Arts, Other
420	Sports Group
421	Athlete
422	Coach
429	Sports, Other
510	Labor Union Group
512	Labor Union Official
511	Labor Union Head
513	Labor Union, Other
520	Labor Union Ministry Group
521	Labor Minister or Lab Ag Head
522	Senior Ministerial Official
523	Ministerial Employee
529	Ministry of Labor, Other
530	Labor Experts Academia Group
531	Deleted--See 213
539	Labor Experts Academia, Other
540	Labor Organization Group
541	Head of Labor Organization
542	Labor Organization Employee
610	Electronic Media Group
611	Head of TV/Radio Station
612	Radio/TV Journalist
613	Electronic Media Technician
619	Electronic Media, Other
620	Print Media Group
621	Editor/Publisher
622	Journalist
623	Tech in Print Media Field
629	Print Media, Other
630	Film as News Media Group
631	Film Maker
639	Film as News Media, Other
710	Opposition Leader
720	Opposition Leader (Legislator)
730	Former Political Official

GTVSVPC**SEVIS Position Code Validation Table**

790	Important Political Figure
800	Military
900	Other

GTVSVTR**SEVIS Termination Reason Code Validation Table**

Code	Description	Usage Indicator
1	Unauthorized Withdrawal	1
2	Death	1
3	Unauthorized Employment	1
4	Drop Below FT Course of Study	1
5	Full Course Time Exceeded	1
6	Change of Nonimmigrant Status	1
7	Nonimmigrant Stat Chnge Denied	1
8	Expulsion	1
9	Suspension	1
10	Absent from Country for 5 Mos.	1
11	Failure to Enroll	1
12	Costs Exceed Resources	1
13	Transfer Student a No Show	1
14	Denied Transfer	1
15	Extension Denied	1
16	Failing to Maintain Status	1
17	Violation of Change of Status	1
18	Change of Status Denied	1
19	Change of Status Withdrawn	1
20	Change of Status Approved	1
21	Transfer Withdrawn	1
22	No Show-Manual Termination	1
23	Authorized Early Withdrawal	1
24	No Show-System Termination	1
25	School Withdrawn	1
1	INACT 1/03 Fail to Pursue Prog	2
2	INACT 1/03Fail to Maint Ins	2
3	INACT 1/03 Convict of a Crime	2
4	INACT 1/03 Disciplinary Action	2
5	INACT 1/03 Unauth Employment	2
6	INACT 1/03 Violat Spons Rules	2
7	INACT 1/03 Violating Prog Regs	2
8	INACT 1/03 Fail to Main FT	2

GTVSVTR**SEVIS Termination Reason Code Validation Table**

Code	Description	Usage Indicator
9	INACT 1/03 Involuntary Susp	2
CONVIC	Conviction of a Crime	2
DISCIP	Disciplinary action	2
ENGEMP	Unauthorized employment	2
FALACT	Fail to Pursue EV Prog Activit	2
FALADD	Fail to submit address change	2
FALINS	Fail to maint health Insurance	2
FALSTD	Fail to maint full course	2
INVSUS	Involuntary suspension	2
OTHER	Other	2
VIOEXV	Violating EV program regs	2
VIOSPN	Violating sponsor rules	2

GTVSVTS**Validation Entries for SEVIS Transmittal Status Code Table**

C	Processing Complete
P	Pending Response from SEVIS
N	No action required
M	Manual - Adjudicated event
W	Waiting for Batch Transmittal
X	Not Sent, User Decision
R	Returned with error

GTVSYSI**System Indicator Validation Table**

A	Alumni
G	General
F	Finance
R	Financial Aid
S	Student
T	Accounts Receivable
C	Courts
H	Human Resources
M	Micro-Faids Interface
U	Utilities
N	Position Control
B	Property Tax
D	Cash Receipts

GTVSYSI**System Indicator Validation Table**

L	Occupational Tax and License
X	Records Indexing
IC	Integration Components
E	Banner XtenderSolutions
TM	Translation Manager
FW	Finance Self-Service
GW	Web General
VR	Voice Response
AW	Advancement Self-Service
SW	Student Self-Service
PW	Employee Self-Service
LW	Faculty/Advisor Self-Service
IF	Kiosk (Information Access)
LC	Luminis Channels for Banner

GUASADM**Capture Table****Capture Rule****Capture Columns**

GOREMAL

GOREMAL_EMAIL_ADDRESS
 GOREMAL_PREFERRED_IND
 GOREMAL_STATUS_IND

GORIROL

GORIROL_ROLE
 GORIROL_ROLE_GROUP

SPBPERS

SPBPERS_BIRTH_DATE
 SPBPERS_LEGAL_NAME
 SPBPERS_NAME_PREFIX
 SPBPERS_NAME_SUFFIX
 SPBPERS_PREF_FIRST_NAME
 SPBPERS_SEX
 SPBPERS_SSN

SPRADDR

SPRADDR_ATYP_CODE
 SPRADDR_CITY
 SPRADDR_CNTY_CODE
 SPRADDR_NATN_CODE
 SPRADDR_STATUS_IND
 SPRADDR_STAT_CODE
 SPRADDR_STREET_LINE1
 SPRADDR_STREET_LINE2
 SPRADDR_STREET_LINE3
 SPRADDR_ZIP

GUASADM

Capture Table	Capture Rule	Capture Columns
SPRIDEN	SPRIDEN_CHANGE_IND is NULL SPRIDEN_ENTITY_IND IN ('P')	SPRIDEN_CHANGE_IND SPRIDEN_ENTITY_IND SPRIDEN_FIRST_NAME SPRIDEN_LAST_NAME SPRIDEN_MI
SPRTELE		SPRTELE_PHONE_AREA SPRTELE_PHONE_EXT SPRTELE_PHONE_NUMBER

GURTPRF

Toolbar and Menu Preference Table

Toolbar Buttons

```
69,Workflow Release,wf_release,G$WF_BUTTON_PRESSED_TRG;,,414.000,18.000,D,
70,Workflow Submit,wf_submit,G$WF_BUTTON_PRESSED_TRG;,,396.000,18.000,D,
71,Open Electronic Document,wf_apply,G$WF_BUTTON_PRESSED_TRG;,,378.000,18.000,D,
72,SEM,sem,,,171.000,63.000,E,
73,Banner Help,banner_help,GUAHELP,,144.000,63.000,E,
74,Internet,internet,,,117.000,63.000,E,
75,MS Powerpoint,powerpoint,,,99.000,63.000,E,
76,MS Excel,excel,,,
```

Display Horizontal Toolbar	Display Vertical Toolbar	Display Hint	Display Form Name	Display Release Number
Y	Y	Y	Y	Y

Display Database Instance	Display Date and Time	Display Required Item Color	Screen XPosition	Button X Position	Display Form Name
Y	Y	Y	232	224	N

GURUPRF

Personal Preference Table

Group	Key	String	Value
DATA_EXTRACT	WIN32COMMON	DIRECTORY	c:\temp
REPORT	WEB	DIRECTORY	http:// your.report.server/ ows-bin/rwcgi60.exe?
WEBOUTPUT	WEB	DIRECTORY	http://yourserver.com/ directory/
MENU	WIN32COMMON	STARTUP_MENU	*MENU

GURUPRF**Personal Preference Table**

Group	Key	String	Value
DATA_EXTRACT	WIN32COMMON	MIME_TYPE	FILE
LDAP	AUTHENTICATION	SERVER	ldap:// your.ldap.server:port/
LDAP	AUTHENTICATION	DN	DN Name
LDAP	AUTHENTICATION	BIND_USER	Bind user.
LDAP	AUTHENTICATION	BIND_PASSWORD	Bind password.
LDAP	SSL	LOCATION	Wallet Location
LDAP	SSL	PASSWORD	Wallet Password
LDAP	SSL	MODE	Authentication Mode
UI	COLOR	BUTTON	r204g204b153
UI	COLOR	CANVAS	r255g255b255
UI	COLOR	RECORD	r204g204b153
UI	COLOR	SEPARATOR	r204g204b0
UI	COLOR	SCROLLBAR	r204g204b0
UI	COLOR	CODE_PROMPT	r0g0b0
CM	LIST	FORMS	APANAME, APAIDEN, APAWPRS, FOAIDEN, FTMAGCY, FTMFMGR, FTMVEND, GXR BANK, PPAIDEN, RCRSUSP, STVINFC, SPAIDEN, SAAQUIK, SRAQUIK, SAAEAPS, SRIPREL, SRQMTCH, STVPREL, SHAEDIS, PEAHIRE, PEA1PAY, NOAEPAF
UI	ALERT	EXIT	Y
UI	ALERT	CONFIDENTIAL	Y
UI	ALERT	DECEASED	Y
UI	COLOR	MESSAGE_CANVAS	r255g255b255
UI	COLOR	LINKS_CANVAS	r255g255b255
UI	COLOR	TREE_CANVAS	r255g255b255

GURUPRF**Personal Preference Table**

Group	Key	String	Value
UI	LINKS	MY_INST	http://www.sungardhe.com/
UI	LINKS	MY_LINK_1DESC	Your first personal link description
UI	LINKS	MY_LINK_1EVENT	Your first personal link URL
UI	LINKS	MY_LINK_2DESC	Your second personal link description
UI	LINKS	MY_LINK_2EVENT	Your second personal link URL
UI	LINKS	MY_LINK_3DESC	Your third personal link description
UI	LINKS	MY_LINK_3EVENT	Your third personal link URL
UI	LINKS	MY_LINK_4DESC	Your fourth personal link description
UI	LINKS	MY_LINK_4EVENT	Your fourth personal link URL
UI	LINKS	MY_LINK_5DESC	Your fifth personal link description
UI	LINKS	MY_LINK_5EVENT	Your fifth personal link URL
UI	LINKS	MY_LINK_6DESC	Your sixth personal link description
UI	LINKS	MY_LINK_6EVENT	Your sixth personal link URL
IMAGE	WEB	DIRECTORY	c:\YourImageDirectory
REPORT	WEB	SERVICE	YourServiceName
HELP	WEB	DIRECTORY	http:// your.banner0H.server/ banner0H/banner0H

Troubleshooting

See the corresponding chapters of the *Banner General User Guide* for messages related to Letter Generation, Population Selection, and Job Submission.

The Banner Error and Warning Messages form (GUAERRM) displays messages generated by APIs. If an error or warning appears in the GUAERRM form, the message was generated by an API. Each API has technical documentation that might help you identify the source of the problem. See Chapter 7, “APIs,” for a list of Banner General APIs and instructions on downloading API documentation.

SQL Trace

An SQL Trace may be performed from within a Banner session. This helps technical support staff track performance issues so they can be resolved.

When you report a performance problem, the Technical Support representative can ask you to turn on the SQL Trace feature and repeat your tasks. As you work, SQL Trace statements are written to a specified directory, where the representative can view them. The statements show all the indexes that Oracle uses to access data.

To turn on SQL Trace, select the Help pull-down menu on the menu bar, then Technical Support, and Turn SQL Trace On.

Note

The end user must turn the trace off or exit Banner to stop creating trace statements. ■

The location of the trace files is determined by the `user_dump_dest` setting in the `init.ora` file.

If someone else is creating trace files when you are, you will have to review the files to determine which were created by your session. The names of the files begin with `ora_` and end with the extension `.trc`. The names are created automatically by the database.

If your environment is running with the multi-threaded server option, all trace data is written to a common file. You may want to investigate setting up another database connection in `tnsnames.ora` file with the use of `(SERVER=DEDICATED)` so your trace file is unique and contains only your session's data.

Use the Oracle utility program `tkprof` to format the output of your trace file.

On the Help pull-down menu on the toolbar, Technical Support expands to two options, Turn SQL Trace On and Turn SQL Trace Off. One or the other will be enabled, depending on if you currently are using the trace feature. You can invoke the trace at any time in your Banner session. You will continue to produce trace statements until you turn the trace off or exit Banner.

GUMAPPL.MMB was updated to add the technical menu to the help section. It has the logic to call routines in the general library to turn the SQL Trace on and off.

 **Note**

If you want to disable the SQL Trace entirely, access the Installation Controls Form (GUAINST) and clear the **SQL Trace Enabled** check box. ■

Starting a SQL Trace in GUAINIT

The General System Global Establishment Form (GUAINIT) allow you to begin a SQL trace from the time the form is launched, and not just during the Banner session. The command line parameter `START_TRACE` is evaluated in the `PRE-FORM` trigger and will start the SQL trace if it is set to *YES*.

Capturing Runtime Statistics

The `CAPTURE_TIMINGS` package provides one location for the capturing of runtime statistics and the saving of those values to a database table. There are two procedures:

- `SET_TIME` copies the value from `gokdbms.utility_get_time` to the global that is passed as a parameter
- `SAVE_INFO` inserts the value of the parameter into the `GURADDL` table based on the setting of the new `TIMING` parameter. The `TIMING` parameter causes timing statistics to be captured at various places in the form and saved to the `GURADDL` table for use in evaluating the current form performance. This was implemented to determine the amount of time it takes to execute different parts of the form. The form sets the starting time after the user has connected to the database in the `PRE-FORM` trigger, and then sets the values several more times in the `DO_FORM_CALL` (prior to building the personal menu, prior to building the product menu, and just prior to invoking the menu form). This code is only used via a new command line (URL) parameter: `TIMING=YES`.

Index

A

Advanced Queuing **3-18**

API Disclaimer **7-7**

APIs

API Disclaimer **7-7**

APIs in Banner General **7-1**

APIs Used in Banner General with
Student Forms and Tables **7-5**

naming conventions **1-1**

Overview **7-1**

B

Banner

naming conventions **1-1**

Banner Event messages **3-18**

BASELINE user ID **1-14**

BFILEs **3-19**

C

C 9-8

compiling **9-8**

standards **1-25**

check boxes **2-40**

check constraints **1-10**

COBOL

compiling **9-2**

debug **6-21**

standards **1-20**

COBOL Standards

style **1-23**

coding standards

C 1-25

column names **1-2**

application tables **1-2**

validation tables **1-3**

Common Forms Object Library (GOQCLIB)
3-17

compiling **9-1**

C 9-8

COBOL **9-2**

form generation **9-1**

mass generation scripts **9-1**

constraint naming conventions **1-8**

check constraints **1-10**

foreign keys **1-8**

primary keys **1-8**

unique **1-10**

constraints **1-8**

foreign key **1-9**

cursors **1-7**

D

data format recommendations **1-12**

database programming objects
naming conventions **1-3**

debug

COBOL **6-21**

development guidelines

blocks **2-38**

buttons **2-41**

check boxes **2-40**

menus **2-42**

naming conventions **2-35**

navigation **2-39**

pull-down lists **2-40**

radio groups **2-40**

scroll bars **2-38**

visual cues **2-36**

directory structure tables **1-15**

E

e-Print **3-19**

eBill **3-19**

EEO reporting **5-13**

error messages

- APIs **T-1**
- GUAERRM **T-1**
- Job Submission **T-1**
- Letter Generation **T-1**
- Population Selection **T-1**
- Ethnic Codes Rule Form (PTRETHN) **5-14**
- ethnicity **5-13**
 - new categories **5-14**

F

- forms **2-35**
 - architecture **2-1**
 - creating custom forms **2-45**
 - custom forms and GUAOBS **1-1**
 - internationalization **2-45**
 - naming conventions **1-1**
 - updating for Banner 8.0 **2-45**

G

- General User Preferences Maintenance Form (GUAUPRF) **6-9**
- global variables **3-1**
 - General **3-2**
- GOQCLIB **3-17**
- GOQOLIB **3-4**
- GOQRPLS
 - procedures in **3-5**
- GOQWFLW **3-17**
- GORBLOB **3-19**
- GORRACE (Race Rules Form) **5-15**
- graphing
 - overview **10-1**
- GTVRRAC (Regulatory Race Validation Form) **5-15**
- GUAINIT **3-1**
 - starting a SQL trace in **T-2**
- GUOPTM fields **2-44**

H

- home directory
 - for job submission **6-45**

I

- I18N
 - forms **2-45**
- ID forms **3-17**
- ID numbers **3-2, 3-4**
- include file **6-42**
- indexes **1-8**
- Instructions **4-1**
- interfaces **8-1**
 - external user systems **8-1**
 - in Banner **8-1**
- internationalization
 - forms **2-45**
- IPEDS Ethnic Validation Table (STVETCT) **5-14**
- IPEDS reporting **5-13, 5-14**

J

- Job Submission **6-34**
 - multiple databases **6-48**
 - Windows NT **6-48**
- job submission
 - home directory **6-45**
 - umask value **6-39**
- Job Submission Profile Maintenance Form (GJAJPRF) **6-9**
- jobs
 - naming conventions **1-1**

L

- Large Objects (LOBs) **3-19**
- LOBs **3-19**
- LOCAL user ID **1-14**
- LOV button **2-35, 2-42**
- Luminis Data Integration **3-18**

M

- mass generation scripts **9-1**

N

- naming conventions **1-1**
 - column names **1-2**

- database programming objects **1-3**
- foreign keys **1-9**
- primary keys **1-9**
- New Ethnicity Code field **5-15**
- nonresident aliens
 - ethnic code reporting **5-15**

O

- Objects **1-1**
- open VMS notes **9-5**
- Oracle Advanced Queuing **3-18**
- Oracle*Reports **6-1**

P

- packaged functions **1-6**
- packages
 - standards **1-6**
- parameters
 - for Oracle reports **6-3, 6-10**
- Perl reports and processes **6-19**
- PIDMs **3-2, 3-4**
 - Duplicate PIDM error **3-3**
- Process Submission Controls Form (GJAPCTL) **6-1, 6-9**
- processes
 - attributes **6-20**
- PTRETHN (Ethnic Codes Rule Form) **5-14**
- pull down lists **2-40**

R

- RAC (Real Application Clusters) and large objects (LOBs) **3-19**
- race and ethnicity **5-13**
 - new categories **5-14**
- Race Rules Form (GORRACE) **5-15**
- radio groups **2-40**
- referential integrity constraints **1-9**
- Regulatory Race Validation Form (GTVRRAC) **5-15**
- Report and Process Attributes Matrix **6-20**
- reports
 - attributes **6-20**
 - Perl **6-19**
- reports and processes **6-20**

- naming conventions **1-1**
- RUN_REPORT_OBJECT **6-9**
- runtime statistics **T-2**

S

- schema owners **1-13**
- sctban.pm **6-42**
- seed data
 - owners **1-13**
- sleep/wake-up **6-30**
- SOBSEQN **3-2, 3-4**
- SPAIDEN **3-17**
- special characters **1-12**
- SPRIDEN_CREATE_USER **3-17**
- SQL Trace **T-1**
- SQL*Plus
 - scripts **6-23**
- STVETCT (IPEDS Ethnic Validation Table) **5-14**
- System indicator **1-1**

T

- tables
 - naming conventions **1-1**
- technical addendum
 - generating **6-50**
- trace mode **6-21**
- triggers **1-3, 1-6, 3-4**
 - procedures **3-5**
 - shared **3-4**

U

- umask
 - for gjajobs.shl **6-39**
- Unified Modeling Language (UML) **2-1**
- unique constraints **1-10**
- UNIX **9-7**
 - COBOL script in **9-7**
 - mass C compile procedures **9-12**
- user IDs
 - BASELINE **1-14**
 - delivered with Banner **1-13**
 - LOCAL **1-14**
- user-defined types **1-7**

V

VMS

notes **9-5**

W

Workflow **3-17**

Workflow Banner Adapter Library
(GOQWFLW) **3-17**